

# TECHNICAL NOTE

**Job Name:** Tunbridge Wells Local Plan

**Job No:** 332611481

**Date:** 28<sup>th</sup> June 2024

**Prepared By:** Daniel Smith / Gary Heard

**Subject:** **A264 Pembury Road corridor – Junction capacity assessment**

## 1. Introduction

- 1.1. Stantec UK (Stantec) have been appointed by Tunbridge Wells Borough Council (TWBC) to provide transport support to the next stages of the Local Plan examination in public.
- 1.2. As part of this support, Stantec have been appointed to assess the A264 Pembury Road corridor to determine whether local junctions can be improved to provide an increase in capacity along this corridor.
- 1.3. With an increase in capacity, it is predicted by the Local Plan SATURN modelling (completed by SWECO) that relief would be provided to the existing A21 Kippings Cross Junction, to the extent that upgrade works to the Kippings Cross junction would not be required as a result of Local Plan development. Implementing improvements to the A264 Pembury Road corridor, rather than implementing improvements to the A21 Kippings Cross junction, would be the preferred strategy of TWBC.
- 1.4. The relief predicted is based upon peak hour trips re-routing to the A264 Pembury Road corridor, rather than using Kippings Cross to avoid the A264 corridor.
- 1.5. The following technical note is an assessment of highway capacity and vehicular throughput, and on this basis does not assess potential improvements to sustainable transport on this corridor. Sustainable transport mode improvements would need to be considered in detail when bringing sites forward for development.

## 2. A264 Pembury Road study area

- 2.1. Stantec have been provided with traffic flow data for 5 local junctions from the Local Plan traffic model, developed using the SATURN software package. Those junction locations are listed and illustrated below:

- Woodgate Corner
- A21 East Dumbbell Roundabout
- A21 West Dumbbell Roundabout
- Halls Hole Road
- Sandhurst Road

- 2.2. The plan opposite highlights the location of the junctions assessed along the length of A264 Pembury Road. The scope comprises the length between the Woodgate Corner junction to the east and the Sandhurst Road junction to the west.

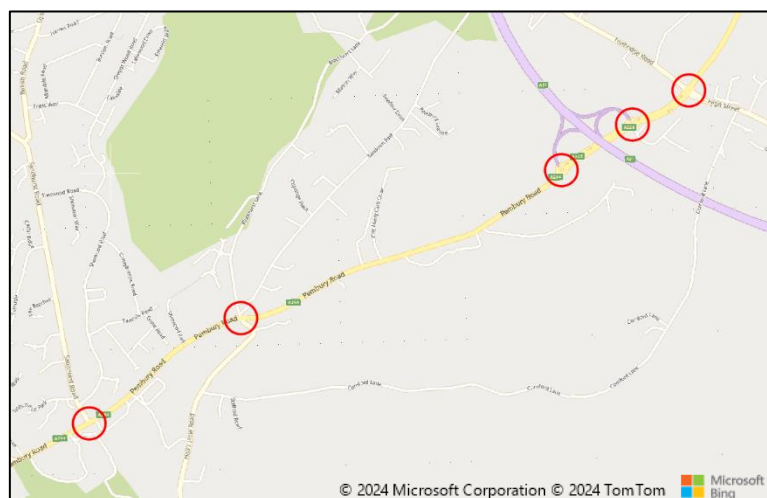

## TECHNICAL NOTE

- 2.3. Following further consultation with KCC, an additional junction assessment was requested by KCC (A264 Pembury Road / Maidstone Road) and this has also been considered (section 10).
- 2.4. Whilst KCC also commented on the A264 Pembury Road / Sandrock Road junction, this has not been assessed at this stage on the basis that it is not identified as a major hotspot within the SWECO modelling work.

### 3. Modelling inputs

- 3.1. Each of the individual junctions has been modelled in detail using Junctions 10 software (for priority and roundabout junctions) or LinSig (for signal-controlled junctions).
- 3.2. Models have been developed based upon the existing junction setups. This includes using the signal timing sheets from Kent County Council (KCC), where applicable, and aerial photography for geometric properties.
- 3.3. The traffic flows for the A264 Pembury Road corridor for each of the above junctions have been provided to Stantec as extracted from the TWBC Local Plan SATURN model. These traffic flows are the basis of the traffic modelling scenarios completed.
- 3.4. Traffic flows have been provided from the strategic SATURN models for two scenario options, those being the Local Plan Highway Mitigation Option 1 (LPHM1) and Local Plan Highway Mitigation Option 2 (LPHM2) scenarios.:
- Option 1 – Includes Colts Hill bypass and Kippings Cross improvements.
  - Option 2 – Includes Colts Hill bypass and 10% saturation flow increase at the Pembury Road junctions, but no Kippings Cross improvements.
- 3.5. The table below summarises the highway interventions included in the SATURN model for each option.

Mitigation	Option 1 (LPHM1)	Option 2 (LPHM2)
Sustainable Transport Interventions (see Chapter 4)	✓	✓
Colts Hill Bypass	✓	✓
Badsell Roundabout Improvements	✓	✓
Somerhill Roundabout Improvements	✓	✓
Hop Farm Roundabout Improvements	✓	✓
Kipping's Cross Roundabout Improvements	✓	
Pembury Road Capacity Improvements		✓

- 3.6. SATURN model flows have been provided to Stantec for the above 2 options. AM and PM peak hour flows have been provided for each option. Demand and actual flows have been provided for each peak hour. This results in 8 sets of traffic flows for each junction.

## TECHNICAL NOTE

- 3.7. It is the case that the Option 2 flows are higher at each of the A264 junctions assessed when compared to the Option 1 flows. This is expected due to the increase in junction capacity assumed in Option 2 within the SATURN model. Stantec have been advised that the Option 2 SATURN model assumes an increase in junction saturation capacity of 10% for all approaches at each junction.
- 3.8. It is noted that each of the junctions considered are modelled “as existing” within the SATURN models, with the exception of the Halls Hole Road junction, which is included in the SATURN models as a roundabout. It is understood that this reflects a committed roundabout scheme at this location.

### 4. Modelling criteria

- 4.1. The Option 1 SATURN model flows reflect no improvements on the A264 corridor (other than Halls Hole Road), whereas the A21 Kippings Cross junction is assumed upgraded. Hence, the SATURN model traffic flows on the A264 corridor in this option reflect a situation whereby no re-routing from Kippings Cross is assumed in SATURN, but instead Kippings Cross is upgraded to cater for traffic flows predicted to use it.
- 4.2. Option 2 SATURN model flows reflect the increase in traffic flows that would occur at each junction on the A264 Pembury Road (compared to Option 1) should the saturation flows at each junction be increased by 10% in the SATURN model, and in the absence of any Kippings Cross upgrade. Hence, the SATURN model traffic flows on the A264 corridor in this option reflect a situation whereby re-routing from Kippings Cross is assumed to occur.
- 4.3. The increase in traffic flows (under Option 2) must be regarded as the level of traffic increase required on the A264 corridor, as a result of induced re-routing of traffic, to sufficiently relieve the A21 Kippings Cross junction.
- 4.4. The rationale followed by this technical note is as follows:
- Model each junction in detail (using LinSig or Junctions10) assuming the Option 1 SATURN traffic flows. This will demonstrate the operation of each junction on the A264 Pembury Road corridor for a scenario where Kippings Cross is upgraded, and no re-routing occurs to the A264 Pembury Road corridor.
  - Model each junction in detail again (using LinSig or Junctions10) assuming the Option 2 SATURN traffic flows. This will demonstrate the operation of each junction on the A264 Pembury Road corridor again, but including the additional traffic that would re-route if the A264 Pembury Road junctions were upgraded in the manner assumed by the Local Plan SATURN modelling (10% increase in saturation flows on the A264 corridor).
  - Model each junction in detail again (using LinSig or Junctions10) assuming the Option 2 SATURN traffic flows and including A264 Pembury Road junction improvement works at each junction. It is proposed that the model performance of each junction using these flows be improved (by assuming physical works or signal timing changes) to the extent that it reflects the Option 1 traffic flow junction performance (at bullet 1 above). It has been assumed that if the junction performance can be improved to this extent, then the junction works modelled would be sufficient to induce the re-routing of traffic from Kippings Cross in the way that the SATURN model predicts.
- 4.5. Hence, the objective adopted within this assessment is to demonstrate that the Option 2 flows can be accommodated by the A264 corridor (following junction improvements) with a similar, or better, level of service as experienced assuming the Option 1 flows (without junction improvements).

## TECHNICAL NOTE

### 5. Modelling assessments

- 5.1. The following sections of this technical note consider each of the junctions assessed in turn and detail the modelling completed for each junction and for the scenarios described above. Each junction has been modelled using either the Junctions10 software package (for roundabouts and priority junctions) or Linsig (for signal controlled junctions).
- 5.2. The geometric input to each model has been based upon measurements taken from OS mapping data. The turning flows adopted within each model are taken from the SWECO modelling output as described above.
- 5.3. The results from the modelling exercise are presented such that a colour coding system has been adopted to demonstrate the following:
  - Green indicates that the approach arm is operating within the desirable capacity parameters generally adopted for new junctions. This is typically a Ratio of Flow to Capacity (RFC) value of 0.85 for priority and roundabout junctions and 90% for signal controlled junctions.
  - Amber indicates that the approach arm exceeds desirable capacity parameters but remains within theoretical capacity. This is typically an RFC of 0.85 to 1.00 for priority and roundabout junctions and 90% to 100% for signal controlled junctions. Amber does not necessarily indicate unacceptable operation for an existing junction
  - Red indicates that the approach arm exceeds theoretical capacity parameters. This is an RFC greater than 1.00 for priority and roundabout junctions and greater than 100% for signal controlled junctions.
- 5.4. The following sections within this report summarise the modelling exercise completed for each junction.

### 6. Woodgate Corner (A228 / Tonbridge Road / High Street)

- 6.1. Woodgate Corner is a signal-controlled junction located at the intersection of A228 Pembury Road, Tonbridge Road and High Street. The existing layout functions as a four-stage controller which uses the following phasing and stage order:
  - Pembury Road East and West Left turns and Ahead movements
  - Pembury Road East and West Right turns and High Street filter lane
  - High Street all movements
  - Tonbridge Road all movements
- 6.2. In each of the above stages, the pedestrian phases are able to activate as a walk with, resulting in no lost time to vehicular movements as a result of pedestrian movements.
- 6.3. LinSig models have been derived and these models have been run using a cycle time of 120 seconds, within which the stage signal timings have been optimised.
- 6.4. Turning flows have been input to the model for the scenarios tabulated below, as extracted from the TWBC Local Plan SATURN model and provided to Stantec. The table also provides a summary of the total junction throughputs modelled.

## TECHNICAL NOTE

	Option 1		Option 2	
	AM peak hour	PM peak hour	AM peak hour	PM peak hour
<b>Actual flows</b>	2698	2794	2852	3034
<b>Demand flows</b>	2826	2839	2984	3080
<b>Increase</b>	4.7%	1.6%	4.6%	1.5%

- 6.5. It is noted that demand flows used for the assessment are around 5% higher than the actual flows during the morning peak hour and 2% during the evening peak hour.

### Existing layout

- 6.6. The following tables provide the modelling output summaries for the Demand flows. Outputs for degree of saturation given as a percentage, Mean Maximum Queue (MMQ) given in Passenger Car Units (PCUs), and total delay in seconds are summarised. The full output for Woodgate Corner existing layout is available within Appendix A.

Option 1 (DEMAND)	AM Peak Hour			PM Peak Hour		
	Deg. Sat (%)	MMQ (PCUs)	Total Delay (secs)	Deg. Sat (%)	MMQ (PCUs)	Total Delay (secs)
Pembury Road E Left and Ahead (Lane 1)	100.9	23.9	16.2	91.6	18.1	9.6
Pembury Road E Ahead and Right (Lane 2 + 3)	103.9	43.7	32.0	94.5	15.7	12.4
Tonbridge Road (Lane 1 + 2)	104.3	31.1	25.0	94.0	23.9	13.2
Pembury Road W Left and Ahead (Lane 1)	104.3	30.8	22.5	95.5	22.3	12.5
Pembury Road W Right Turn Only (Lane 2)	28.7	4.2	1.6	75.2	8.9	4.6
High Street (Lane 1 + 2)	104.3	37.4	25.4	91.1	18.6	10.2
PRC (%)	<b>-15.9</b>			<b>-6.1</b>		
Delay (PCU hr)	122.73			62.49		
Cycle Time (s)	120			120		

## TECHNICAL NOTE

Option 2 DEMAND	AM Peak Hour			PM Peak Hour		
	Deg. Sat (%)	MMQ (PCUs)	Total Delay (secs)	Deg. Sat (%)	MMQ (PCUs)	Total Delay (secs)
Pembury Road E Left and Ahead (Lane 1)	110.6	43.2	35.0	103.8	32.9	23.4
Pembury Road E Ahead and Right (Lane 2 + 3)	112.6	75.9	60.5	105.0	27.0	23.7
Tonbridge Road (Lane 1 + 2)	111.5	42.5	37.9	108.5	68.1	52.4
Pembury Road W Left and Ahead (Lane 1)	114.1	54.2	45.4	109.3	47.5	37.4
Pembury Road W Right Turn Only (Lane 2)	27.7	4.2	1.6	89.9	11.5	6.9
High Street (Lane 1 + 2)	114.1	60.6	48.6	101.2	28.2	19.2
PRC (%)	-26.8			-21.4		
Delay (PCU hr)	229.01			162.98		
Cycle Time (s)	120			120		

6.7. As can be seen within the above tables, the Option 2 flows increase the Degree of Saturation (DoS) on all lane approaches to the junction when compared against the Option 1 flows, with almost all lane approaches for the junction exceeding 100% DoS.

### Junction improvement

6.8. Optioneering has been completed for the Woodgate Corner junction, whereby different parameters have been adjusted to determine whether they would release additional capacity to return the performance of the junction back to that experienced by the Option 1 flows. Following comments received from KCC, the pedestrian crossing locations have been retained as existing, rather than relocating to alternative arms of the junction. The main parameters which have been assessed are as follows:

- Existing lane width widening
- Additional lanes
- Increasing flare lengths
- Phase / Stage reconfiguration

6.9. Based upon highway boundary data information, improvements have been included to increase capacity as follows:

- Pembury Road west arm – Add a flare for the ahead and left movement
- A 2 lane to 1 lane merge on Pembury Road east arm exit.

# TECHNICAL NOTE

- Road marking changes on the Pembury Road east arm to make the right turn into Tonbridge Road a long lane rather than a flare. This changes the nearside left lane to a flare.
- Increased flare length on the High Street from 25m to 50m.

6.10. This scheme has been sketched in CAD on an OS base mapping background and is included as Appendix B with an extract shown below. It is noted that the scheme would fit within the highway boundary, based upon highway boundary data provided by TWBC officers.

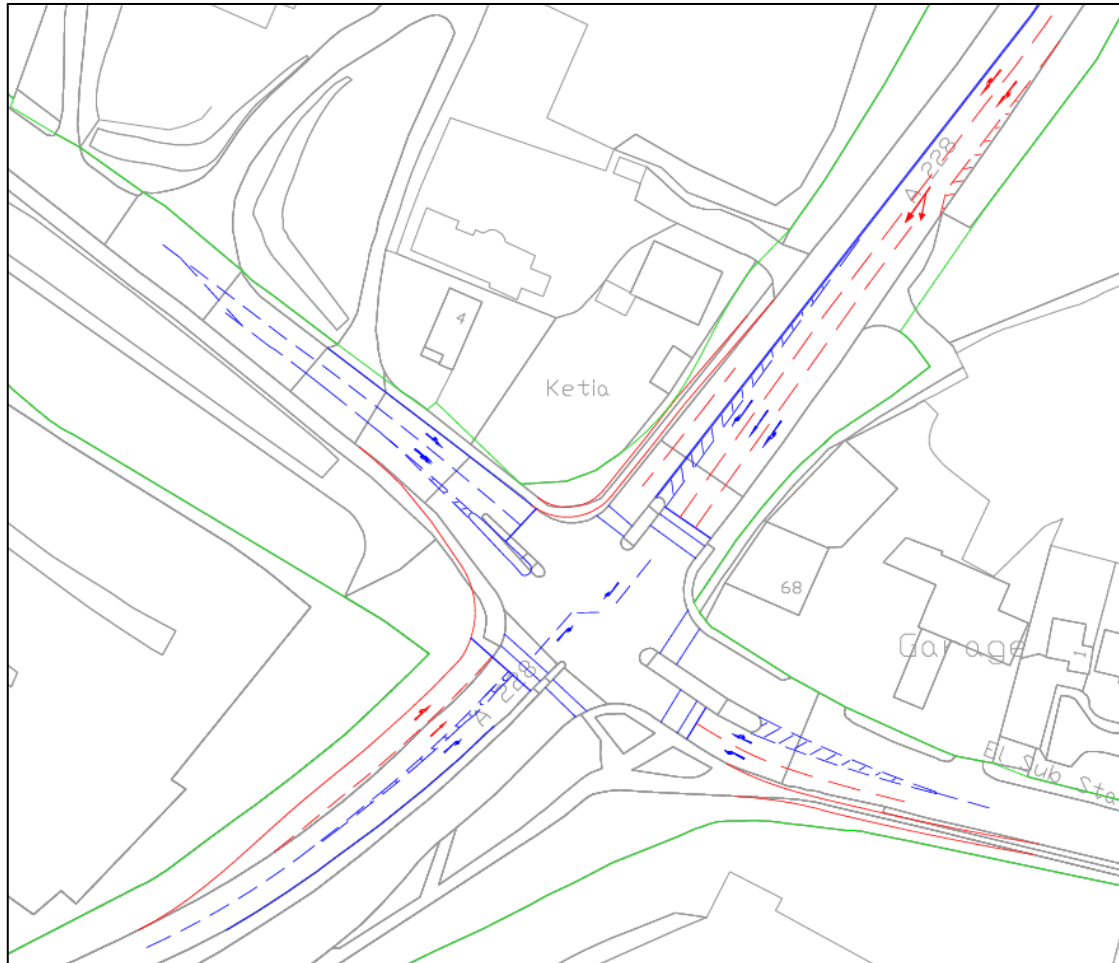

6.11. By implementing the above changes and re-optimising the junction, the following results are provided. A full output for this potential scheme is provided in Appendix C.

Option 2 DEMAND	AM Peak Hour			PM Peak Hour		
	Deg. Sat (%)	MMQ (PCUs)	Total Delay (secs)	Deg. Sat (%)	MMQ (PCUs)	Total Delay (secs)
Pembury Road E Left and Ahead (Lane 1 + 2)	97.5	20.2	18.0	93.7	17.1	14.7
Pembury Road E Ahead and Right	98.8	30.3	17.1	94.5	14.3	9.0

## TECHNICAL NOTE

(Lane 3)						
<b>Tonbridge Road (Lane 1 + 2)</b>	97.5	19.8	14.5	97.4	33.5	17.8
<b>Pembury Road W Left and Ahead (Lane 1 + 2)</b>	82.6	10.4	8.9	85.8	11.4	9.8
<b>Pembury Road W Right Turn Only (Lane 3)</b>	26.4	4.1	1.5	80.9	9.8	5.2
<b>High Street (Lane 1 + 2)</b>	92.4	13.9	10.0	88.5	16.8	9.5
PRC (%)	<b>-9.8</b>			<b>-8.3</b>		
Delay (PCU hr)	69.94			66.09		
Cycle Time (s)	120			120		

- 6.12. For the AM peak, on a lane-by-lane assessment, the junction is shown to improve in terms of overall performance when compared to the Option 1 scenario. With respect to the PM peak, the junction is shown to perform marginally worse, however the junction is still shown to work within capacity during this peak, with no lanes exceeding 100% DoS.
- 6.13. It is further noted that the combined delay (AM + PM) in Option 1 is  $122.73 + 62.49 = 185.22$  PCUhrs whilst the mitigation scheme reduces this to  $69.94 + 66.09 = 136.03$  PCUhrs. Hence, an overall reduction in delay.
- 6.14. Therefore, it is proposed that the junction improvement assessed would present a physical upgrade that would reflect the effect of the SATURN modelling assumptions at this junction.
- 6.15. It is the case that the improvement scheme is illustrative in nature and would need to be subject to the usual technical and safety audit process checks as well as a costing exercise and check against utilities locations. Nevertheless, at this stage it demonstrates that a physical scheme, should one be required, could be accommodated at this location to release junction capacity.

## 7. A21 east dumbbell roundabout

- 7.1. The A21 east dumbbell roundabout is a 4-arm roundabout providing access to the Tesco supermarket and access to and from the southbound A21 strategic link.
- 7.2. This junction has been modelled based on the geometrical properties observed from aerial photography, which has been directly input and scaled within the modelling software, Junctions 10. This allows for an accurate representation of the junction layout.
- 7.3. Turning flows have been input to the model for the scenarios tabulated below, as extracted from the TWBC Local Plan SATURN model and provided to Stantec. The table also provides a summary of the total junction throughputs modelled.



## TECHNICAL NOTE

	Option 1		Option 2	
	AM peak hour	PM peak hour	AM peak hour	PM peak hour
<b>Actual flows</b>	2569	3062	2711	3224
<b>Demand flows</b>	2703	3098	2835	3266
<b>Increase</b>	5.2%	1.2%	4.6%	1.3%

- 7.4. It is noted that demand flows used for the assessment are around 5% higher than the actual flows during the morning peak hour and 1% during the evening peak hour.

### Existing layout

- 7.5. The following tables provide the modelling output summaries for the Demand flows. Outputs for Ratio of Flow to Capacity (RFC), Queue given in Passenger Car Units (PCUs), and total delay in PCU seconds are summarised. The full output for existing layout is available within Appendix D.

Option 1 (DEMAND)	AM Peak Hour				PM Peak Hour			
	RFC	Queue (PCU)	Delay (s)	Total Delay/P CU (s)	RFC	Queue (PCU)	Delay (s)	Total Delay/P CU (s)
Pembury Road E	0.55	1.2	4.00	3.38	0.58	1.4	4.36	4.54
Tesco Access	0.21	0.3	8.33		0.53	1.1	12.51	
Pembury Road W	0.40	0.7	2.38		0.56	1.3	3.32	
A21	0.34	0.5	2.95		0.33	0.5	3.30	

Option 2 DEMAND	AM Peak Hour				PM Peak Hour			
	RFC	Queue (PCU)	Delay (s)	Total Delay/P CU (s)	RFC	Queue (PCU)	Delay (s)	Total Delay/P CU (s)
Pembury Road E	0.07	0.1	2.00	3.01	0.61	1.5	4.68	4.97
Tesco Access	0.11	0.1	3.56		0.56	1.3	14.20	
Pembury Road W	0.50	1.0	2.87		0.62	1.6	3.77	
A21	0.37	0.6	3.39		0.35	0.5	3.53	

- 7.6. On the basis of the above modelling results, the junction is shown to work within capacity for all demand scenarios. It is therefore determined that no junction improvement is required for this location to be able to accommodate the demand flows, including re-routing from the A21 Kippings Cross junction.

## TECHNICAL NOTE

### 8. A21 west dumbbell roundabout

- 8.1. The A21 west dumbbell roundabout is a 3-arm roundabout providing access to and from the northbound A21 strategic link.
- 8.2. This junction has been modelled based on the geometrical properties observed from aerial photography, which has been directly input and scaled within the modelling software, Junctions 10. This allows for an accurate representation of the junction layout.
- 8.3. Turning flows have been input to the model for the scenarios tabulated below, as extracted from the TWBC Local Plan SATURN model and provided to Stantec. The table also provides a summary of the total junction throughputs modelled.

	Option 1		Option 2	
	AM peak hour	PM peak hour	AM peak hour	PM peak hour
<b>Actual flows</b>	3885	3730	4049	3891
<b>Demand flows</b>	4123	3864	4286	4012
<b>Increase</b>	6.1%	3.6%	5.9%	3.1%

- 8.4. It is noted that demand flows used for the assessment are around 6% higher than the actual flows during the morning peak hour and 3%-4% during the evening peak hour.

### Existing layout

- 8.5. The model assigns the Option 1 and Option 2 scenario traffic flows, and the results of these scenarios are summarised in the tables below. The full output is available within Appendix E.

Option 1 (DEMAND)	AM Peak Hour				PM Peak Hour			
	RFC	Queue (PCU)	Delay (s)	Total Delay/P CU (s)	RFC	Queue (PCU)	Delay (s)	Total Delay/P CU (s)
Pembury Road E	0.93	10.9	24.23	66.44	0.91	9.1	19.69	15.51
Pembury Road W	1.07	80.8	121.22		0.89	7.7	15.47	
A21	0.37	0.6	3.02		0.37	0.6	3.54	

Option 2 DEMAND	AM Peak Hour				PM Peak Hour			
	RFC	Queue (PCU)	Delay (s)	Total Delay/P CU (s)	RFC	Queue (PCU)	Delay (s)	Total Delay/P CU (s)
Pembury Road E	0.93	11.3	25.22	123.87	0.94	12.9	27.34	23.43
Pembury Road W	1.14	153.7	235.15		0.94	13.4	25.90	
A21	0.39	0.6	3.19		0.40	0.7	3.95	

## TECHNICAL NOTE

- 8.6. As can be see within the above tables, the Option 2 scenario increases the Ratio of Flow to Capacity (RFC) of the A264 Pembury Road (west) arm further above the 1.00 threshold during the AM peak. Other arms are shown to be over saturated, where the RFC values are over 0.85.
- 8.7. It has been determined, for the purposes of this assessment, that the junction would need an improvement scheme to reduce the Option 2 operation back to the Option 1 operation for the A264 Pembury Road (west) AM peak.

### Junction improvement

- 8.8. Optioneering has been completed for the A21 west dumbbell roundabout, where different geometric parameters have been assessed to determine if they would allow the Option 2 flows to perform as well as the Option 1 flows. The changes that have been made to the model have been summarised below:
- A264 Pembury Road east
    - Entry width increased from 8.59m to 9.00m
    - Effective flare length increased from 19.7m to 30.0m
  - A264 Pembury Road west
    - Entry width increased from 9.97m to 12.00m
    - Effective flare length increased from 13.6m to 35.0m
- 8.9. With respect to the A264 Pembury Road westbound exit lane, this has been shown to comprise 2 lanes merging to 1 following discussions with KCC officers. This also reflects the current generous exit width and formalises this to 2 marked lanes. Such an arrangement allows westbound vehicles to use either lane on the approach to the roundabout for straight ahead movements.
- 8.10. The total entry width for the Pembury Road west arm is greater than that of the circulatory width. Whilst this would normally be an issue in terms of highway design, the new layout proposes a dedicated left turn lane added to the junction. Hence, the vehicles in this lane are not expected to enter the gyratory. Notwithstanding the need for a road safety audit to be completed for the proposed mitigation, this would seem acceptable.
- 8.11. The scheme has been sketched in CAD on an Ordnance Survey (OS) base mapping background and is included as Appendix F and an extract shown below. It is noted that the scheme would fit within the highway boundary, based upon highway boundary data provided by TWBC officers.

## TECHNICAL NOTE



- 8.12. With these geometric properties updated, the model was re-run with Option 2 flows to provide an updated summary of results. This update has been summarised in the table below. The full output for the junction is available within Appendix G.

Option 2 DEMAND	AM Peak Hour				PM Peak Hour			
	RFC	Queue (PCU)	Delay (s)	Total Delay/P CU (s)	RFC	Queue (PCU)	Delay (s)	Total Delay/P CU (s)
Pembury Road E	0.89	7.2	15.78	13.09	0.90	8.0	16.59	9.78
Pembury Road W	0.90	8.5	14.04		0.75	2.9	5.39	
A21	0.41	0.7	3.58		0.40	0.7	3.97	

- 8.13. It is noted that the junction improvements assessed would improve the performance of the model using Option 2 flows, to a betterment when compared to the Option 1 model.
- 8.14. Therefore, it is proposed that the junction improvement scheme would present a physical upgrade that would reflect the effect of the SATURN modelling assumptions at this junction.
- 8.15. KCC highways officers have also raised the matter of the existing pedestrian crossing to the west of the junction and the manner in which this interacts with the roundabout junction. It is advised that this interaction be investigated during detailed analysis of a highway scheme at this junction to avoid queues blocking back from the crossing to the roundabout.

## TECHNICAL NOTE

- 8.16. It is the case that the improvement scheme is illustrative in nature and would need to be subject to the usual technical and safety audit process checks as well as a costing exercise and check against utilities locations. Nevertheless, at this stage it demonstrates that a physical scheme, should one be required, could be accommodated at this location to release junction capacity.

### 9. Halls Hole Road junction

- 9.1. Halls Hole Road forms a signal-controlled junction at the intersection with Pembury Road and Blackhurst Lane. The existing layout functions as a three-stage controller which uses the following phasing and stage order:

- Pembury Road east and west - All movements with right turn give-ways
- All red pedestrians phase
- Blackhurst Lane and Halls Hole Road - All movements with right turn give-ways

- 9.2. LinSig models have been derived and these models have been run using a cycle time of 120 seconds, within which the stage signal timings have been optimised.

- 9.3. Turning flows have been input to the model for the scenarios tabulated below, as extracted from the TWBC Local Plan SATURN model and provided to Stantec. The table also provides a summary of the total junction throughputs modelled.

	Option 1		Option 2	
	AM peak hour	PM peak hour	AM peak hour	PM peak hour
<b>Actual flows</b>	3903	3724	4123	3950
<b>Demand flows</b>	4064	3844	4278	4063
<b>Increase</b>	4.1%	3.2%	3.8%	2.9%

- 9.4. It is noted that demand flows used for the assessment are around 4% higher than the actual flows during the morning peak hour and 3% during the evening peak hour.

#### Existing layout

- 9.5. The following tables provide the modelling output summaries for the Demand flows from the strategic modelling for both scenarios. The full output for the existing Halls Hole Road Junction is available within Appendix H.

Option 1 (DEMAND)	AM Peak Hour			PM Peak Hour		
	Deg. Sat (%)	MMQ (PCUs)	Total Delay (secs)	Deg. Sat (%)	MMQ (PCUs)	Total Delay (secs)
Pembury Road W	157.7	383.2	351.9	133.3	256.4	223.2
Blackhurst Lane	84.3	6.1	5.1	69.8	3.3	2.2
Pembury Road E	174.9	483.1	451.7	173.7	503.9	469.0
Halls Hole Road	171.6	95.3	89.0	164.6	82.3	76.7

## TECHNICAL NOTE

PRC (%)	<b>-94.4</b>	<b>-93.0</b>
Delay (PCU hr)	897.72	770.98
Cycle Time (s)	120	120

Option 2 DEMAND	AM Peak Hour			PM Peak Hour		
	Deg. Sat (%)	MMQ (PCUs)	Total Delay (secs)	Deg. Sat (%)	MMQ (PCUs)	Total Delay (secs)
Pembury Road W	<b>174.2</b>	467.3	437.0	<b>186.7</b>	345.6	314.4
Blackhurst Lane	<b>84.3</b>	6.1	5.0	<b>71.5</b>	3.3	2.3
Pembury Road E	<b>182.7</b>	514.4	484.3	<b>180.1</b>	538.2	503.6
Halls Hole Road	<b>183.8</b>	123.0	115.4	<b>180.9</b>	106.9	100.3
PRC (%)	<b>-104.3</b>			<b>-107.4</b>		
Delay (PCU hr)	1041.77			920.62		
Cycle Time (s)	120			120		

- 9.6. As can be seen within the above tables, the Option 2 flows increase the Degree of Saturation (DoS) on all lane approaches to the junction when compared against Option 1, with almost all lane approaches for the junction exceeding 100% DoS in both options.

### Committed roundabout scheme

- 9.7. The strategic SATURN modelling for this junction has been set up as a roundabout, whereby a committed roundabout scheme has been assumed at this location. The committed roundabout scheme has also been assessed assuming the Option 1 and Option 2 flows.
- 9.8. The following tables provide the modelling output summaries for the committed roundabout scheme with the Demand flows from both options. The full output for the committed scheme at Halls Hole Road is available within Appendix I.

Option 1 (DEMAND)	AM Peak Hour				PM Peak Hour			
	RFC	Queue (PCU)	Delay (s)	Total Delay/P CU (s)	RFC	Queue (PCU)	Delay (s)	Total Delay/P CU (s)
Pembury Road W	<b>1.20</b>	163.4	356.45	456.82	<b>1.07</b>	71.5	138.37	448.17
Blackhurst Lane	<b>0.86</b>	4.9	77.63		<b>0.38</b>	0.6	22.91	
Pembury Road E	<b>1.31</b>	301.8	676.15		<b>1.35</b>	361.6	786.97	
Halls Hole Road	<b>0.74</b>	2.9	28.06		<b>0.54</b>	1.2	12.85	

## TECHNICAL NOTE

Option 2 DEMAND	AM Peak Hour				PM Peak Hour			
	RFC	Queue (PCU)	Delay (s)	Total Delay/P CU (s)	RFC	Queue (PCU)	Delay (s)	Total Delay/P CU (s)
Pembury Road W	1.32	286.3	649.83	615.08	1.19	154.2	331.49	648.07
Blackhurst Lane	0.93	7.1	112.67		0.41	0.7	25.03	
Pembury Road E	1.34	343.1	768.71		1.42	453.5	1061.40	
Halls Hole Road	0.88	6.3	53.29		0.63	1.7	15.53	

- 9.9. As can be seen within the tables above, the committed roundabout scheme will provide a better operation than the existing signal control, albeit the junction is still predicted to perform over capacity in all scenarios.
- 9.10. On the basis that the strategic SATURN model has assumed the committed roundabout, the roundabout layout has been taken forward to assess further in this technical note.

### Junction improvement

- 9.11. Optioneering has been completed for the committed roundabout, where different geometric parameters have been assessed to determine if they would allow the Option 2 flows to perform as well as the Option 1 flows. The changes that have been made to the model have been summarised below:
- Pembury Road east
    - Entry width increased from 7.00m to 8.00m
    - Effective flare length increased from 25.8m to 30.0m
    - Entry angle decreased from 32.0° to 28.0°
  - Blackhurst Lane
    - Entry width increased from 4.50m to 5.20m
    - Effective flare length increased from 18.4m to 20.0m
  - Pembury Road west
    - Entry width increased from 6.93m to 7.50m
    - Effective Flare Length increased from 13.9m to 17.0m
- 9.12. This scheme has been sketched in CAD on an OS base mapping background and is included as Appendix J and an extract shown below. It is noted that the scheme would not fit within the highway boundary, based upon highway boundary data provided by TWBC officers. Hence, the land ownership to deliver the committed roundabout and its further upgrade would need to be addressed prior to implementation.

## TECHNICAL NOTE

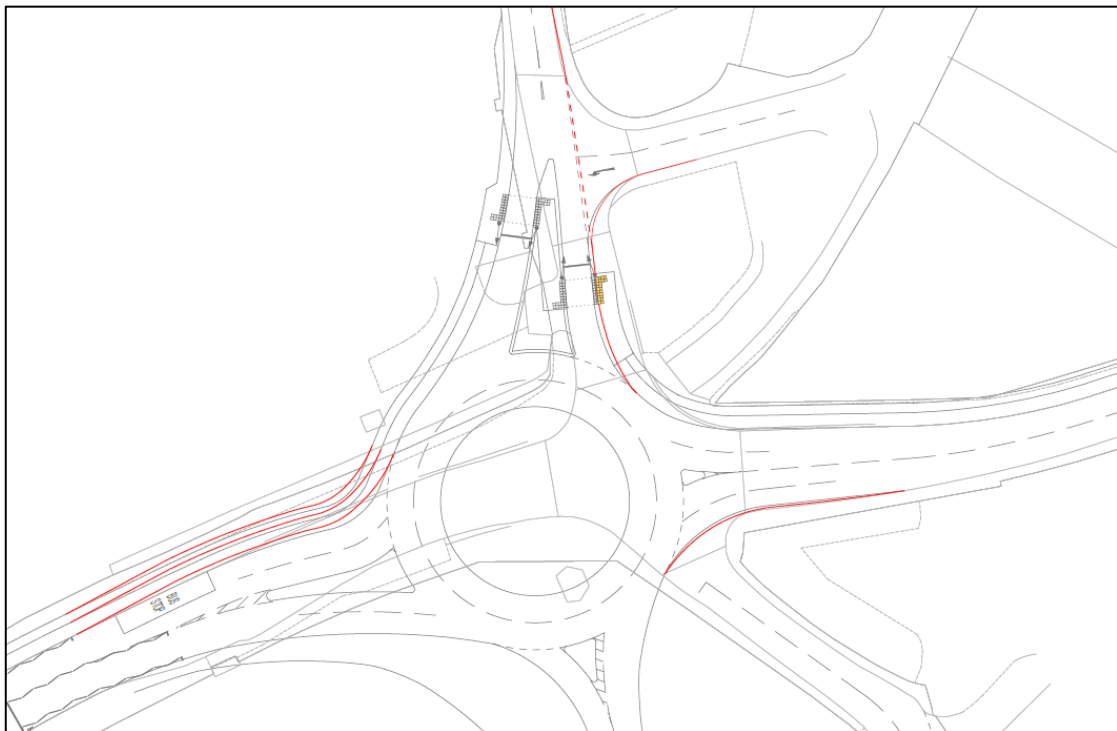

- 9.13. With these geometric properties updated, the model was re-run with Option 2 flows to provide an updated summary of results. This update has been summarised in the table below. The full output for the junction is available within Appendix K.

Option 2 DEMAND	AM Peak Hour				PM Peak Hour			
	RFC	Queue (PCU)	Delay (s)	Total Delay/P CU (s)	RFC	Queue (PCU)	Delay (s)	Total Delay/P CU (s)
Pembury Road W	1.17	153.6	301.20	373.74	1.06	63.3	114.40	405.89
Blackhurst Lane	0.97	9.0	139.23		0.42	0.7	27.07	
Pembury Road E	1.26	245.2	533.76		1.34	352.3	740.52	
Halls Hole Road	0.97	11.9	98.08		0.67	2.0	18.52	

- 9.14. It is noted that the junction improvements assessed would improve the performance of the model using Option 2 flows, to a betterment when compared to the Option 1 model.
- 9.15. Therefore, it is proposed that the junction improvement scheme would present a physical upgrade (over and above the committed roundabout scheme) that would reflect the effect of the SATURN modelling assumptions at this junction. The scheme demonstrated represents a single scheme option and other options could be explored at the time that mitigation needs to be considered for implementation.
- 9.16. It is the case that the improvement scheme is illustrative in nature and would need to be subject to the usual technical and safety audit process checks as well as a costing exercise and check against utilities locations. Nevertheless, at this stage it demonstrates that a physical scheme, should one be required, could be accommodated at this location to release junction capacity.



## TECHNICAL NOTE

### Sensitivity test

- 9.17. In addition to the modelling for the committed roundabout scheme, a sensitivity test has been completed for the existing signal-controlled layout to determine if a capacity increase could be achieved based on the current highway constraints.
- 9.18. A test has been completed which assumes the following:
- The existing western crossing is moved further west, effectively removing the crossing from the junction and relocating the footway provision on the southern side to reflect the changed routing for pedestrians. The pedestrian crossing has been moved to a position that allows for 13 PCUs to store without blocking the main junction.
  - The northern crossing has been upgraded from a single crossing length to a split crossing with a refuge area between. By including this, the pedestrian phases no longer require an all-red vehicle stage to be included.
- 9.19. With the change to the western crossing, the model has been updated to allow for vehicles queuing at this crossing to be assessed, to ensure that there will be enough storage capacity if there is a pedestrian phase called, to not cause any blocking back at the main junction. This has split the existing controller into two traffic streams, so each part of the junction (main junction and offset pedestrian crossing) can be controlled together.
- 9.20. With these changes, the junction is proposed to still function as a three-stage controller that now uses the following phasing and stage order:
- Pembury Road east and west - All movements with right turn give-ways, plus Blackhurst Lane exit pedestrian phase
  - Halls Hole Road - All movements, plus Blackhurst Lane exit pedestrian phase
  - Blackhurst Lane – All movements, plus Blackhurst Lane entry pedestrian phase
- 9.21. The western crossing creates an all red for the eastbound and westbound traffic along Pembury Road.
- 9.22. This scheme has been sketched in CAD on an OS base mapping background and is included as Appendix L with an extract shown below. It is noted that the scheme would fit within the highway boundary, based upon highway boundary data provided by TWBC officers.

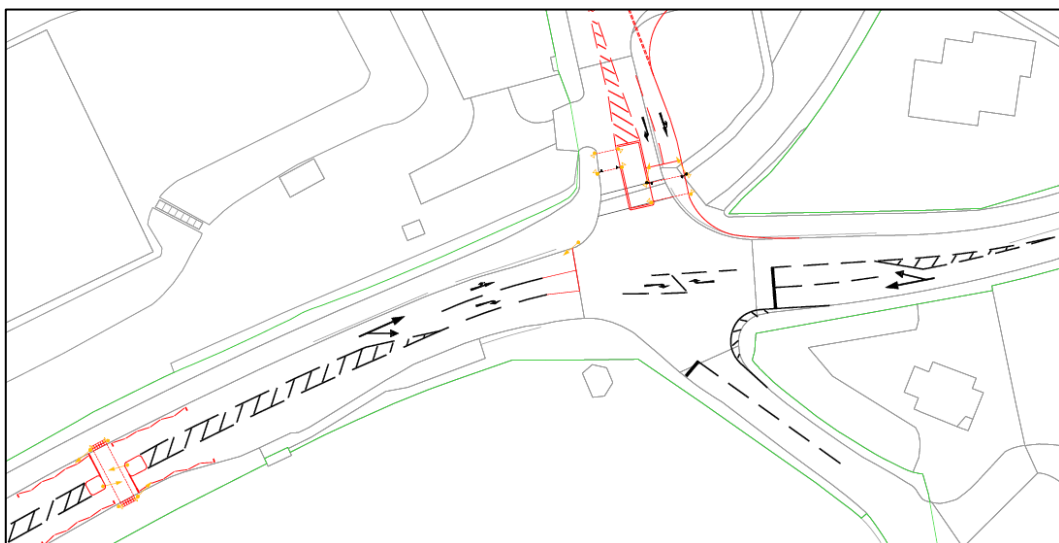

## TECHNICAL NOTE

- 9.23. With these changes made in the model, the junction has been re-optimised within the 120 second cycle time, and the results of this improvement scheme has been summarised in the table below. The full output for this Halls Hole Road sensitivity scheme is available within Appendix M.

Option 2 DEMAND	AM Peak Hour			PM Peak Hour		
	Deg. Sat (%)	MMQ (PCUs)	Total Delay (secs)	Deg. Sat (%)	MMQ (PCUs)	Total Delay (secs)
Pembury Road W	144.3	336.8	298.5	141.7	284.7	251.0
Blackhurst Lane	100.6	9.9	9.5	62.2	3.2	2.2
Pembury Road E	154.7	416.4	378.9	157.2	448.9	413.2
Halls Hole Road	151.6	95.0	87.7	155.1	84.6	79.2
PRC (%)	<b>-71.9</b>			<b>-74.6</b>		
Delay (PCU hr)	844.77			763.59		
Cycle Time (s)	120			120		

- 9.24. It can be seen from the above table, when compared against the Option 1 flows scenario, the junction is able to demonstrate an improvement whereby the total junction delay reduces significantly with the improvement scheme.
- 9.25. It is further noted that the total junction delay reduces from 898 PCUhrs to 845 PCUhrs during the morning peak hour and from 771 PCUhrs to 764 PCUhrs during the evening peak hour (when comparing the junction improvement with Option 2 flows and the existing layout with Option 1 flows). This reduction further demonstrates the ability of the improvement modelled to reduce delay on this corridor,
- 9.26. Therefore, it is proposed that the junction improvement scheme would present a physical upgrade (retaining the existing signal control rather than committed roundabout) that would reflect the effect of the SATURN modelling assumptions at this junction.
- 9.27. It is the case that the improvement scheme is illustrative in nature and would need to be subject to the usual technical and safety audit process checks as well as a costing exercise and check against utilities locations. Nevertheless, at this stage it demonstrates that a physical scheme, should one be required, could be accommodated at this location to release junction capacity.

## 10. Sandhurst Road junction

- 10.1. Sandhurst Road forms a priority give way junction with the Pembury Road corridor, with a right-turn bay also provided.
- 10.2. This junction has been modelled based on the geometrical properties observed from aerial photography, which has been directly input and scaled within the modelling software, Junctions 10. This allows for an accurate representation of the junction layout.
- 10.3. Turning flows have been input to the model for the scenarios tabulated below, as extracted from the TWBC Local Plan SATURN model and provided to Stantec. The table also provides a summary of the total junction throughputs modelled.

## TECHNICAL NOTE

	Option 1		Option 2	
	AM peak hour	PM peak hour	AM peak hour	PM peak hour
<b>Actual flows</b>	3348	3054	3450	3178
<b>Demand flows</b>	3494	3152	3602	3270
<b>Increase</b>	4.4%	3.2%	4.4%	2.9%

- 10.4. It is noted that demand flows used for the assessment are around 4% higher than the actual flows during the morning peak hour and 3% during the evening peak hour.

### Existing layout

- 10.5. The Junctions 10 model assigned the Option 1 and Option 2 scenario traffic flows added, and the results of these scenarios are summarised in the tables below. The full output is available within Appendix N.

Option 1 (DEMAND)	AM Peak Hour				PM Peak Hour			
	RFC	Queue (PCU)	Delay (s)	Total Delay/P CU (s)	RFC	Queue (PCU)	Delay (s)	Total Delay/P CU (s)
Sandhurst Road	999999 9999	941.2	599999 40	133777 66.17	999999 9999	836.8	599999 40	132681 44.1
Right Turn to Sandhurst Road	1.42	267.5	1582.5 4		1.37	212	1173.7	

Option 2 DEMAND	AM Peak Hour				PM Peak Hour			
	RFC	Queue (PCU)	Delay (s)	Total Delay/P CU (s)	RFC	Queue (PCU)	Delay (s)	Total Delay/P CU (s)
Sandhurst Road	999999 9999	1073.8	599999 40	145425 25.24	999999 9999	890.3	599999 40	137252 21.37
Right Turn to Sandhurst Road	1.46	297	1712.4 8		1.4	232.9	1346.3 2	

- 10.6. As can be seen in the above tables, the junction is currently performing over capacity, with the traffic on Sandhurst Road essentially unable to leave the junction due to conflicts with opposing traffic along A264 Pembury Road.
- 10.7. Due to this, the junction is expected to require a change from the priority junction layout to a signal-controlled layout to achieve an improvement.

### Improvement scheme

- 10.8. In order to improve the operation of the junction, a signal controlled junction has been assessed.
- 10.9. A layout has been considered that assumes a single lane approach on all arms, with a flare available at the stop line to allow for each movement to store independently. The design will also incorporate a sheep pen pedestrian crossing on the west arm. The proposed phasing and staging order are as follows:

## TECHNICAL NOTE

- Pembury Road west left turn filter and Sandhurst Lane all movements
- Pembury Road west all movements and Pembury Road east ahead
- All Red pedestrians stage
- Pembury Road east all movements and Sandhurst Road left turn filter. There are numerous junction examples whereby a left turn / filter is provided without physically segregating from other movements from the same arm.

10.10. This scheme has been sketched in CAD on an OS base mapping background and is included as Appendix O and an extract shown below. It is noted that the scheme would fit within the highway boundary, based upon highway boundary data provided by TWBC officers.



10.11. Due to the potential setup of the junction and the requirements of pedestrian crossings, to facilitate the existing local crossing locations, an all red stage for pedestrian crossings would be required.

10.12. The model has been run using a cycle time of 120 seconds, within which the stage signal timings have been optimised.

10.13. The following table provides the modelling output summaries for the Demand flows from the strategic modelling for and option 2. The full output for is available within Appendix P.

Option 2 DEMAND	AM Peak Hour			PM Peak Hour		
	Deg. Sat (%)	MMQ (PCUs)	Total Delay (secs)	Deg. Sat (%)	MMQ (PCUs)	Total Delay (secs)
<b>Pembury Road W Left and Ahead (Lane 1+ 2)</b>	135.0	202.6	180.0	128.7	174.5	151.4
<b>Pembury Road E Ahead and Right (Lane 1 + 2)</b>	126.9	214.5	192.0	130.1	205.9	185.8

## TECHNICAL NOTE

<b>Sandhurst Road (Lane 1 + 2)</b>	<b>134.5</b>	151.9	138.6	<b>115.0</b>	80.6	67.3
PRC (%)	<b>-50.0</b>			<b>-44.6</b>		
Delay (PCU hr)	510.69			404.50		
Cycle Time (s)	120			120		

- 10.14. Whilst this still shows the junction performing over capacity, with all arms over 100% DoS, the junction is now able to release a proportion of traffic from Sandhurst Road.
- 10.15. It can be seen from the above table, when compared against the Option 1 flows scenario, the junction is able to demonstrate an improvement in operation, albeit a larger improvement scheme would need to be implemented to demonstrate the junction operating within capacity with the SATURN traffic flows predicted.
- 10.16. Nevertheless, it is proposed that the junction improvement scheme would present a physical upgrade that would reflect the effect of the SATURN modelling assumptions at this junction.
- 10.17. It is the case that the improvement scheme is illustrative in nature and would need to be subject to the usual technical and safety audit process checks as well as a costing exercise and check against utilities locations. Nevertheless, at this stage it demonstrates that a physical scheme, should one be required, could be accommodated at this location to release junction capacity.

### 11. A264 Pembury Road / Maidstone Road

- 11.1. Following further consultation with KCC, an additional junction assessment was requested by KCC (A264 Pembury Road / Maidstone Road) and this has also been considered.
- 11.2. This junction is a priority give way junction whereby Maidstone Road gives way to the mainline flows on the A264 Pembury Road in both the eastbound and westbound directions. As Pembury Road is a dual carriageway at this location, there is storage available for right turning vehicles (from Maidstone Road) in the central reserve area.
- 11.3. The right turning vehicles from the A264 Pembury Road into Maidstone Road give way to the westbound traffic on the A264 Pembury Road, but are also required to give way to any vehicles which are exiting Maidstone Road and turning right.
- 11.4. This junction has been modelled based on the geometrical properties observed from aerial photography, which has been directly input and scaled within the modelling software, Junctions 10. This allows for an accurate representation of the junction layout. This requires 2 separate models to model each of the give way lines.
- 11.5. Due to the intricacies of vehicles interacting at this junction, the junction was also created within LinSig as a further check, where the give-way parameters can be linked within a single model.
- 11.6. Turning flows have been input to the model for the scenarios tabulated below, as extracted from the TWBC Local Plan SATURN model and provided to Stantec. The table also provides a summary of the total junction throughputs modelled.

## TECHNICAL NOTE

	Option 1		Option 2	
	AM peak hour	PM peak hour	AM peak hour	PM peak hour
<b>Actual flows</b>	2219	2164	2263	2301
<b>Demand flows</b>	2348	2252	2394	2345
<b>Increase</b>	5.8%	4.1%	5.8%	1.9%

- 11.7. It is noted that demand flows used for the assessment are around 6% higher than the actual flows during the morning peak hour and 3% during the evening peak hour.

### Existing layout

- 11.8. Due to the existing junction layout (not being a simple give-way) the Junctions 10 modelling was completed based on separate models for the individual give ways. The following tables provide the modelling output summaries for the Demand flows. Outputs for Ratio of Flow to Capacity (RFC), Queue given in Passenger Car Units (PCUs), and total delay in PCU seconds are summarised. The full output for existing layout is available within Appendix Q.

Option 1 (DEMAND)	AM Peak Hour				PM Peak Hour			
	RFC	Queue (PCU)	Delay (s)	Total Delay/P CU (s)	RFC	Queue (PCU)	Delay (s)	Total Delay/P CU (s)
Maidstone Road (Junction)	0.17	0.2	16.08	0.91	0.13	0.1	12.48	0.82
Pembury Road WB	0.00	0.0	0.00		0.00	0.0	0.00	
Pembury Road EB Priority	0.00	0.0	0.00		0.00	0.0	0.00	
Pembury Road EB Priority	0.00	0.0	0.00	0.00	0.00	0.0	0.00	0.00
Maidstone Road (Right Turn Storage)	0.16	0.2	7.77	0.65	0.17	0.2	8.3	0.56

Option 2 (DEMAND)	AM Peak Hour				PM Peak Hour			
	RFC	Queue (PCU)	Delay (s)	Total Delay/P CU (s)	RFC	Queue (PCU)	Delay (s)	Total Delay/P CU (s)
Maidstone Road (Junction)	0.15	0.2	16.42	0.77	0.08	0.1	11.69	0.50
Pembury Road WB	0	0.0	0.00		0	0.0	0.00	
Pembury Road EB Priority	0	0.0	0.00		0	0.0	0.00	
Pembury Road EB Priority	0	0.0	0.00	0.00	0	0.0	0.00	0.00
Maidstone Road (Right Turn Storage)	0.14	0.2	7.62	0.53	0.11	0.1	8.16	0.32

- 11.9. It is noted that the Junctions 10 software predicts the junction to operate well within capacity for all scenarios based upon the traffic flows from the Local Plan SATURN model.

## TECHNICAL NOTE

- 11.10. As a double check of the modelling completed within Junctions 10, the junction was also modelled using the LinSig software as a single model. This was created using the standard give way setting used for priority movements, as set out by JCT (Software Creators). The full output of the LinSig model is available as Appendix R.

Option 1 DEMAND	AM Peak Hour			PM Peak Hour		
	Deg. Sat (%)	MMQ (PCUs)	Total Delay (secs)	Deg. Sat (%)	MMQ (PCUs)	Total Delay (secs)
Pembury Road WB	65.5	0.9	0.9	52.6	0.6	0.6
Maidstone Road Give Way @ Junction	23.7	0.2	0.2	19.8	0.1	0.1
Maidstone Road Give Way @ Storage	19.5	0.1	0.1	19.8	0.1	0.1
Pembury Road EB	44.2	0.4	0.4	52.6	0.6	0.6
Pembury Road EB Giveaway						

Option 2 DEMAND	AM Peak Hour			PM Peak Hour		
	Deg. Sat (%)	MMQ (PCUs)	Total Delay (secs)	Deg. Sat (%)	MMQ (PCUs)	Total Delay (secs)
Pembury Road WB	67.1	1.0	1.0	52.7	0.6	0.6
Maidstone Road Give Way @ Junction	20.8	0.1	0.1	12.5	0.1	0.1
Maidstone Road Give Way @ Storage	16.6	0.1	0.1	13.2	0.1	0.1
Pembury Road EB	45.5	0.4	0.4	58.5	0.7	0.7

- 11.11. On the basis of the above modelling results, the junction is shown to work within capacity for all demand scenarios.
- 11.12. It is therefore demonstrated that no junction improvement is required at this location to accommodate the demand flows, based upon the Local Plan SATURN model outputs.

## 12. Findings

- 12.1. On the basis of the study described above, the following findings are presented:
- Based upon modelling by SWECO, an increase in capacity on the A264 Pembury Road corridor is predicted to relieve the A21 Kippings Cross Junction, to the extent that upgrade works to the Kippings Cross junction would not be required as a result of Local Plan development. This would reflect the preference of TWBC to implement improvements to the A264 Pembury Road corridor, rather than the Kippings Cross junction.

## TECHNICAL NOTE

- The relief predicted is based upon peak hour trips re-routing to an upgraded A264 Pembury Road corridor, rather than using Kippings Cross to avoid the A264 corridor.
- The Woodgate Corner (A228 / Tonbridge Road / High Street) junction would require upgrade works comprising widening and flare lengthening and pedestrian crossing relocation to demonstrate an operational improvement assuming Option 2 flows, when compared to Option 1 flows. An illustrative scheme is presented and assessed that achieves this.
- The A21 east dumbbell roundabout is predicted to work within capacity for all demand scenarios. It is therefore determined that no junction improvement is required for this location.
- The A21 west dumbbell roundabout would require upgrade works comprising widening and flare lengthening to demonstrate an operational improvement assuming Option 2 flows, when compared to Option 1 flows. An illustrative scheme is presented and assessed that achieves this.
- The Halls Hole Road junction has been modelled as the existing signals and also a committed roundabout scheme. The committed roundabout scheme will provide a better operation than the existing signal control.
- The committed roundabout layout has been taken forward to assess further and minor additional flaring and widening works would be required to demonstrate an operational improvement assuming Option 2 flows, when compared to Option 1 flows. An illustrative scheme is presented and assessed that achieves this.
- A sensitivity test has also been completed whereby the existing signal controlled layout is assumed and an upgrade considered. An improvement scheme has been considered that relocates the crossing to the west and widens the north arm, including splitting the crossing movement, to demonstrate an operational improvement assuming Option 2 flows, when compared to Option 1 flows. An illustrative scheme is presented and assessed that achieves this.
- The Sandhurst Road junction would require upgrade works comprising conversion to signal control to demonstrate an operational improvement assuming Option 2 flows, when compared to Option 1 flows. An illustrative scheme is presented and assessed that achieves this.
- The Maidstone Road junction is predicted to work within capacity for all demand scenarios. It is therefore determined that no junction improvement is required for this location.
- The improvement schemes described are illustrative in nature and would need to be subject to the usual technical and safety audit process checks as well as a costing exercise and check against utilities locations. Nevertheless, at this stage it is demonstrated that physical schemes, should these be required, could be accommodated to release junction capacity.
- In summary, the modelling exercise shows the junction improvements needed (and achievable) to serve the traffic growth predicted by the SWECO SATURN model when comparing the A264 Pembury Road corridor improved scenario (option 2), with the A264 Pembury Road corridor not improved scenario (option 1).



## TECHNICAL NOTE

- The objective adopted within the assessment is to demonstrate that the Option 2 flows can be accommodated by the A264 corridor (following junction improvements) with a similar, or better, level of service as experienced assuming the Option 1 flows (without junction improvements). Serving this traffic growth (with no deterioration in junction performance) would be expected to negate the need to upgrade Kippings Cross.

**Appendix A**  
**Woodgate Corner Existing Layout Modelling Results**

Full Input Data And Results  
**Full Input Data And Results**

**User and Project Details**

<b>Project:</b>	
<b>Title:</b>	
<b>Location:</b>	
<b>Additional detail:</b>	
<b>File name:</b>	Woodgate Corner (Existing Layout).lsg3x
<b>Author:</b>	
<b>Company:</b>	
<b>Address:</b>	

### Network Layout Diagram

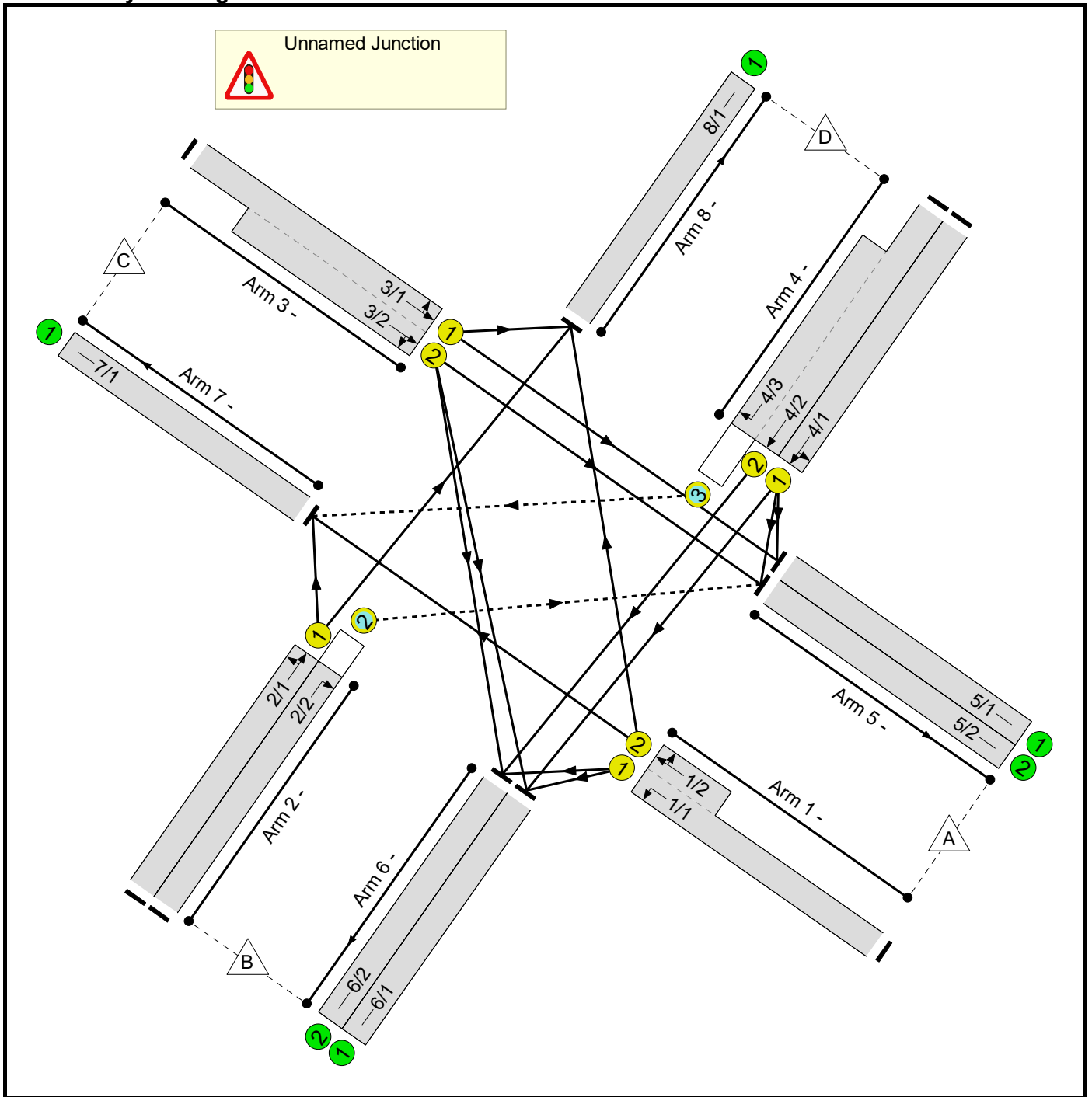

Phase Diagram

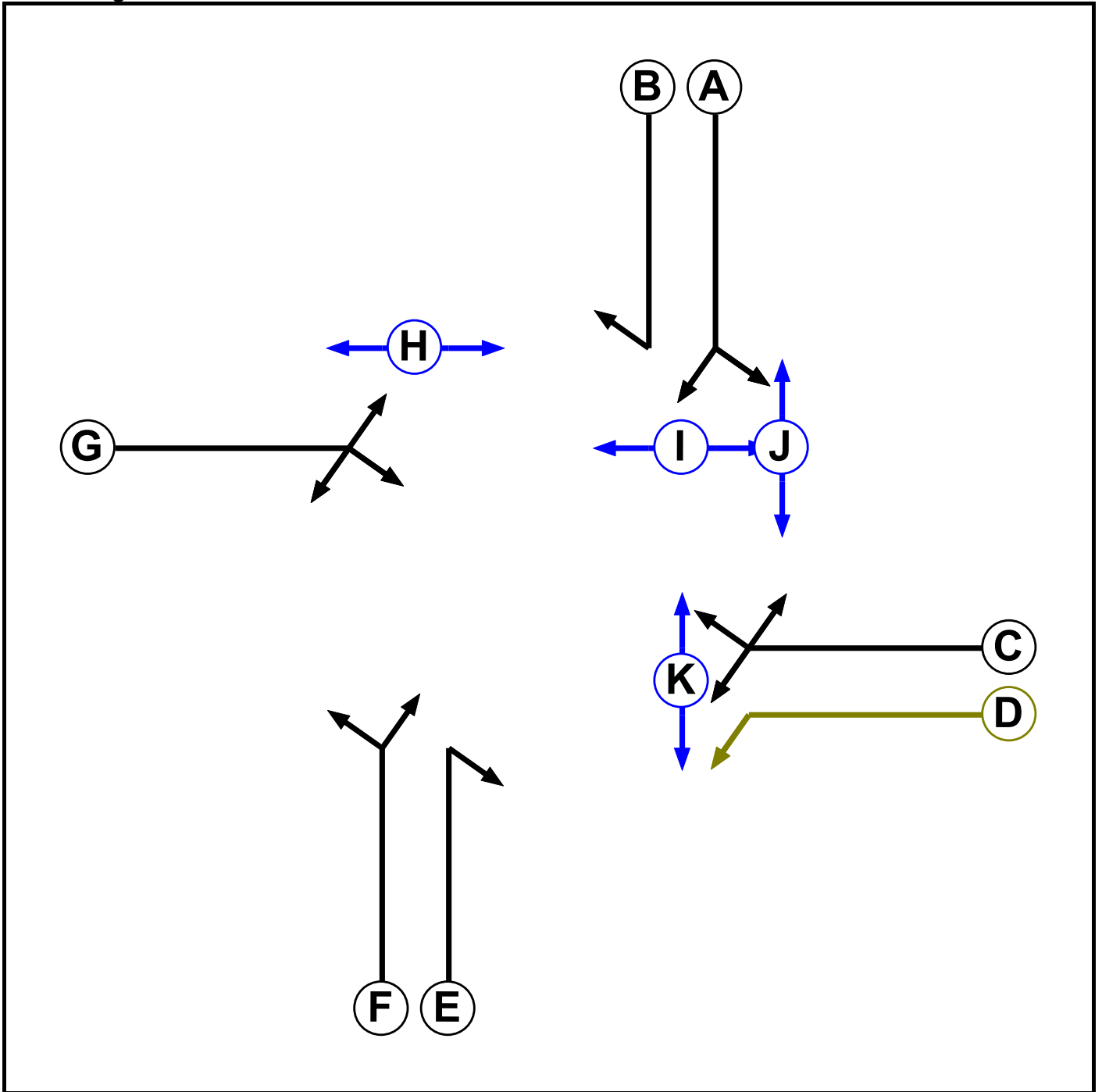

# Full Input Data And Results

## Phase Input Data

Phase Name	Phase Type	Assoc. Phase	Street Min	Cont Min
A	Traffic		7	7
B	Traffic		7	7
C	Traffic		7	7
D	Filter	C	1	0
E	Traffic		7	7
F	Traffic		7	7
G	Traffic		7	7
H	Pedestrian		6	6
I	Pedestrian		6	6
J	Pedestrian		6	6
K	Pedestrian		6	6

## Phase Intergreens Matrix

Terminating Phase	Starting Phase										
	A	B	C	D	E	F	G	H	I	J	K
A	-	-	5	6	5	-	5	-	5	8	-
B	-	-	5	-	-	7	5	-	5	-	-
C	5	6	-	6	7	7	11	-	-	-	5
D	5	-	-	-	-	5	-	-	-	-	5
E	6	-	5	-	-	5	-	-	9	-	-
F	-	5	5	-	-	-	6	8	-	-	-
G	6	5	5	6	5	5	-	7	-	8	-
H	-	-	5	-	-	6	8	-	-	-	-
I	11	11	-	-	-	-	-	-	-	-	-
J	7	-	-	-	6	-	6	-	-	-	-
K	-	-	8	8	-	-	-	-	-	-	-

## Phases in Stage

Stage No.	Phases in Stage
1	A F K
2	B D E H
3	C I J
4	G I K

## Stage Diagram

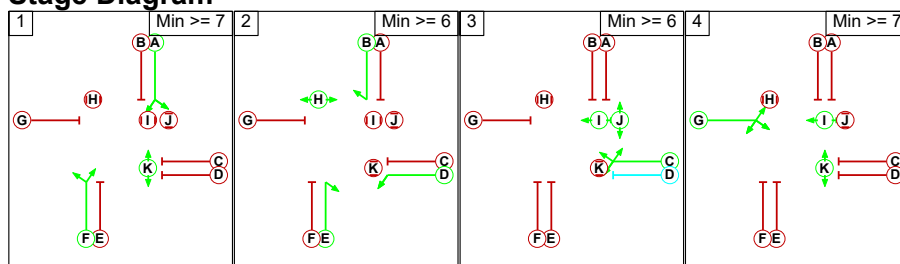

## Full Input Data And Results

### Phase Delays

Term. Stage	Start Stage	Phase	Type	Value	Cont value
4	1	G	Losing	5	5

### Prohibited Stage Change

From Stage	To Stage			
	1	2	3	4
1	8	8	8	6
2	X	9	X	
3	11	11	7	
4	11	11	8	

Full Input Data And Results

**Give-Way Lane Input Data**

Junction: Unnamed Junction											
Lane	Movement	Max Flow when Giving Way (PCU/Hr)	Min Flow when Giving Way (PCU/Hr)	Opposing Lane	Opp. Lane Coeff.	Opp. Mvmnts.	Right Turn Storage (PCU)	Non-Blocking Storage (PCU)	RTF	Right Turn Move up (s)	Max Turns in Intergreen (PCU)
2/2	5/2 (Right)	1439	0	4/1	1.09	All	2.00	-	0.50	2	2.00
				4/2		All					
4/3	7/1 (Right)	1439	0	2/1	1.09	All	3.00	-	0.50	3	3.00



Full Input Data And Results

**Lane Input Data**

Junction: Unnamed Junction												
Lane	Lane Type	Phases	Start Disp.	End Disp.	Physical Length (PCU)	Sat Flow Type	Def User Saturation Flow (PCU/Hr)	Lane Width (m)	Gradient	Nearside Lane	Turns	Turning Radius (m)
1/1	U	C D	2	3	60.0	Geom	-	3.34	0.00	Y	Arm 6 Left	14.50
1/2	U	C	2	3	4.3	Geom	-	3.34	0.00	Y	Arm 7 Ahead	Inf
											Arm 8 Right	18.50
2/1	U	F	2	3	27.8	Geom	-	3.92	0.00	Y	Arm 7 Left	13.50
											Arm 8 Ahead	Inf
2/2	O	E	2	3	27.8	Geom	-	4.30	0.00	Y	Arm 5 Right	11.50
3/1	U	G	2	3	60.0	Geom	-	4.12	0.00	Y	Arm 5 Ahead	Inf
											Arm 8 Left	10.50
3/2	U	G	2	3	11.3	Geom	-	4.01	0.00	Y	Arm 5 Ahead	Inf
											Arm 6 Right	19.00
4/1	U	A	2	3	60.0	Geom	-	3.41	0.00	Y	Arm 5 Left	11.50
											Arm 6 Ahead	Inf
4/2	U	A	2	3	60.0	Geom	-	3.38	0.00	N	Arm 6 Ahead	Inf
4/3	O	B	2	3	13.0	Geom	-	3.21	0.00	Y	Arm 7 Right	15.50
5/1	U		2	3	60.0	Inf	-	-	-	-	-	-
5/2	U		2	3	60.0	Inf	-	-	-	-	-	-
6/1	U		2	3	60.0	Inf	-	-	-	-	-	-
6/2	U		2	3	60.0	Inf	-	-	-	-	-	-
7/1	U		2	3	60.0	Inf	-	-	-	-	-	-
8/1	U		2	3	60.0	Inf	-	-	-	-	-	-

**Traffic Flow Groups**

Flow Group	Start Time	End Time	Duration	Formula
1: 'Option 1 AM Demand'	08:00	09:00	01:00	
2: 'Option 1 PM Demand'	17:00	18:00	01:00	
3: 'Option 2 AM Demand'	08:00	09:00	01:00	
4: 'Option 2 PM Demand'	17:00	18:00	01:00	
5: 'Option 1 AM Actual'	08:00	09:00	01:00	
6: 'Option 1 PM Actual'	17:00	18:00	01:00	
7: 'Option 2 AM Actual'	08:00	09:00	01:00	
8: 'Option 2 PM Actual'	17:00	18:00	01:00	

Full Input Data And Results

**Scenario 1: 'Option 1 AM Demand'** (FG1: 'Option 1 AM Demand', Plan 1: 'Network Control Plan 1')

**Traffic Flows, Desired**

**Desired Flow :**

	Destination					
		A	B	C	D	Tot.
Origin	A	0	392	46	126	564
	B	160	0	28	405	593
	C	108	28	0	370	506
	D	37	591	515	0	1143
	Tot.	305	1011	589	901	2806

**Traffic Lane Flows**

Lane	Scenario 1: Option 1 AM Demand
<b>Junction: Unnamed Junction</b>	
1/1 (with short)	564(In) 392(Out)
1/2 (short)	172
2/1	433
2/2	160
3/1 (with short)	506(In) 370(Out)
3/2 (short)	136
4/1	390
4/2 (with short)	753(In) 238(Out)
4/3 (short)	515
5/1	19
5/2	286
6/1	563
6/2	448
7/1	589
8/1	901

Full Input Data And Results

**Lane Saturation Flows**

Junction: Unnamed Junction								
Lane	Lane Width (m)	Gradient	Nearside Lane	Allowed Turns	Turning Radius (m)	Turning Prop.	Sat Flow (PCU/Hr)	Flared Sat Flow (PCU/Hr)
1/1	3.34	0.00	Y	Arm 6 Left	14.50	100.0 %	1766	1766
1/2	3.34	0.00	Y	Arm 7 Ahead	Inf	26.7 %	1840	1840
				Arm 8 Right	18.50	73.3 %		
2/1	3.92	0.00	Y	Arm 7 Left	13.50	6.5 %	1993	1993
				Arm 8 Ahead	Inf	93.5 %		
2/2	4.30	0.00	Y	Arm 5 Right	11.50	100.0 %	1809	1809
3/1	4.12	0.00	Y	Arm 5 Ahead	Inf	0.0 %	1773	1773
				Arm 8 Left	10.50	100.0 %		
3/2	4.01	0.00	Y	Arm 5 Ahead	Inf	79.4 %	1984	1984
				Arm 6 Right	19.00	20.6 %		
4/1	3.41	0.00	Y	Arm 5 Left	11.50	9.5 %	1932	1932
				Arm 6 Ahead	Inf	90.5 %		
4/2	3.38	0.00	N	Arm 6 Ahead	Inf	100.0 %	2093	2093
4/3	3.21	0.00	Y	Arm 7 Right	15.50	100.0 %	1765	1765
5/1	Infinite Saturation Flow						Inf	Inf
5/2	Infinite Saturation Flow						Inf	Inf
6/1	Infinite Saturation Flow						Inf	Inf
6/2	Infinite Saturation Flow						Inf	Inf
7/1	Infinite Saturation Flow						Inf	Inf
8/1	Infinite Saturation Flow						Inf	Inf

**Scenario 2: 'Option 1 PM Demand'** (FG2: 'Option 1 PM Demand', Plan 1: 'Network Control Plan 1')

**Traffic Flows, Desired**

**Desired Flow :**

		Destination				
		A	B	C	D	Tot.
Origin	A	0	381	14	88	483
	B	238	0	0	479	717
	C	121	92	0	496	709
	D	68	570	292	0	930
	Tot.	427	1043	306	1063	2839

## Full Input Data And Results

### Traffic Lane Flows

Lane	Scenario 2: Option 1 PM Demand
<b>Junction: Unnamed Junction</b>	
1/1 (with short)	483(In) 381(Out)
1/2 (short)	102
2/1	479
2/2	238
3/1 (with short)	709(In) 496(Out)
3/2 (short)	213
4/1	424
4/2 (with short)	506(In) 214(Out)
4/3 (short)	292
5/1	34
5/2	393
6/1	593
6/2	450
7/1	306
8/1	1063

Full Input Data And Results

**Lane Saturation Flows**

Junction: Unnamed Junction								
Lane	Lane Width (m)	Gradient	Nearside Lane	Allowed Turns	Turning Radius (m)	Turning Prop.	Sat Flow (PCU/Hr)	Flared Sat Flow (PCU/Hr)
1/1	3.34	0.00	Y	Arm 6 Left	14.50	100.0 %	1766	1766
1/2	3.34	0.00	Y	Arm 7 Ahead	Inf	13.7 %	1822	1822
				Arm 8 Right	18.50	86.3 %		
2/1	3.92	0.00	Y	Arm 7 Left	13.50	0.0 %	2007	2007
				Arm 8 Ahead	Inf	100.0 %		
2/2	4.30	0.00	Y	Arm 5 Right	11.50	100.0 %	1809	1809
3/1	4.12	0.00	Y	Arm 5 Ahead	Inf	0.0 %	1773	1773
				Arm 8 Left	10.50	100.0 %		
3/2	4.01	0.00	Y	Arm 5 Ahead	Inf	56.8 %	1950	1950
				Arm 6 Right	19.00	43.2 %		
4/1	3.41	0.00	Y	Arm 5 Left	11.50	16.0 %	1916	1916
				Arm 6 Ahead	Inf	84.0 %		
4/2	3.38	0.00	N	Arm 6 Ahead	Inf	100.0 %	2093	2093
4/3	3.21	0.00	Y	Arm 7 Right	15.50	100.0 %	1765	1765
5/1	Infinite Saturation Flow						Inf	Inf
5/2	Infinite Saturation Flow						Inf	Inf
6/1	Infinite Saturation Flow						Inf	Inf
6/2	Infinite Saturation Flow						Inf	Inf
7/1	Infinite Saturation Flow						Inf	Inf
8/1	Infinite Saturation Flow						Inf	Inf

**Scenario 3: 'Option 2 AM Demand'** (FG3: 'Option 2 AM Demand', Plan 1: 'Network Control Plan 1')

**Traffic Flows, Desired**

**Desired Flow :**

		Destination				
		A	B	C	D	Tot.
Origin	A	0	402	48	136	586
	B	163	0	47	463	673
	C	104	31	0	346	481
	D	67	581	596	0	1244
	Tot.	334	1014	691	945	2984

## Full Input Data And Results

### Traffic Lane Flows

Lane	Scenario 3: Option 2 AM Demand
<b>Junction: Unnamed Junction</b>	
1/1 (with short)	586(In) 402(Out)
1/2 (short)	184
2/1	510
2/2	163
3/1 (with short)	481(In) 346(Out)
3/2 (short)	135
4/1	460
4/2 (with short)	784(In) 188(Out)
4/3 (short)	596
5/1	34
5/2	300
6/1	610
6/2	404
7/1	691
8/1	945

Full Input Data And Results

**Lane Saturation Flows**

Junction: Unnamed Junction								
Lane	Lane Width (m)	Gradient	Nearside Lane	Allowed Turns	Turning Radius (m)	Turning Prop.	Sat Flow (PCU/Hr)	Flared Sat Flow (PCU/Hr)
1/1	3.34	0.00	Y	Arm 6 Left	14.50	100.0 %	1766	1766
1/2	3.34	0.00	Y	Arm 7 Ahead	Inf	26.1 %	1839	1839
				Arm 8 Right	18.50	73.9 %		
2/1	3.92	0.00	Y	Arm 7 Left	13.50	9.2 %	1987	1987
				Arm 8 Ahead	Inf	90.8 %		
2/2	4.30	0.00	Y	Arm 5 Right	11.50	100.0 %	1809	1809
3/1	4.12	0.00	Y	Arm 5 Ahead	Inf	0.0 %	1773	1773
				Arm 8 Left	10.50	100.0 %		
3/2	4.01	0.00	Y	Arm 5 Ahead	Inf	77.0 %	1980	1980
				Arm 6 Right	19.00	23.0 %		
4/1	3.41	0.00	Y	Arm 5 Left	11.50	14.6 %	1920	1920
				Arm 6 Ahead	Inf	85.4 %		
4/2	3.38	0.00	N	Arm 6 Ahead	Inf	100.0 %	2093	2093
4/3	3.21	0.00	Y	Arm 7 Right	15.50	100.0 %	1765	1765
5/1	Infinite Saturation Flow						Inf	Inf
5/2	Infinite Saturation Flow						Inf	Inf
6/1	Infinite Saturation Flow						Inf	Inf
6/2	Infinite Saturation Flow						Inf	Inf
7/1	Infinite Saturation Flow						Inf	Inf
8/1	Infinite Saturation Flow						Inf	Inf

**Scenario 4: 'Option 2 PM Demand'** (FG4: 'Option 2 PM Demand', Plan 1: 'Network Control Plan 1')

**Traffic Flows, Desired**

**Desired Flow :**

		Destination				
		A	B	C	D	Tot.
Origin	A	0	393	12	83	488
	B	244	0	47	496	787
	C	158	108	0	606	872
	D	67	588	278	0	933
	Tot.	469	1089	337	1185	3080

## Full Input Data And Results

### Traffic Lane Flows

Lane	Scenario 4: Option 2 PM Demand
<b>Junction: Unnamed Junction</b>	
1/1 (with short)	488(In) 393(Out)
1/2 (short)	95
2/1	543
2/2	244
3/1 (with short)	872(In) 606(Out)
3/2 (short)	266
4/1	482
4/2 (with short)	451(In) 173(Out)
4/3 (short)	278
5/1	34
5/2	435
6/1	666
6/2	423
7/1	337
8/1	1185



**Lane Saturation Flows**

Junction: Unnamed Junction								
Lane	Lane Width (m)	Gradient	Nearside Lane	Allowed Turns	Turning Radius (m)	Turning Prop.	Sat Flow (PCU/Hr)	Flared Sat Flow (PCU/Hr)
1/1	3.34	0.00	Y	Arm 6 Left	14.50	100.0 %	1766	1766
1/2	3.34	0.00	Y	Arm 7 Ahead	Inf	12.6 %	1820	1820
				Arm 8 Right	18.50	87.4 %		
2/1	3.92	0.00	Y	Arm 7 Left	13.50	8.7 %	1988	1988
				Arm 8 Ahead	Inf	91.3 %		
2/2	4.30	0.00	Y	Arm 5 Right	11.50	100.0 %	1809	1809
3/1	4.12	0.00	Y	Arm 5 Ahead	Inf	0.0 %	1773	1773
				Arm 8 Left	10.50	100.0 %		
3/2	4.01	0.00	Y	Arm 5 Ahead	Inf	59.4 %	1953	1953
				Arm 6 Right	19.00	40.6 %		
4/1	3.41	0.00	Y	Arm 5 Left	11.50	13.9 %	1921	1921
				Arm 6 Ahead	Inf	86.1 %		
4/2	3.38	0.00	N	Arm 6 Ahead	Inf	100.0 %	2093	2093
4/3	3.21	0.00	Y	Arm 7 Right	15.50	100.0 %	1765	1765
5/1	Infinite Saturation Flow						Inf	Inf
5/2	Infinite Saturation Flow						Inf	Inf
6/1	Infinite Saturation Flow						Inf	Inf
6/2	Infinite Saturation Flow						Inf	Inf
7/1	Infinite Saturation Flow						Inf	Inf
8/1	Infinite Saturation Flow						Inf	Inf

**Scenario 1: 'Option 1 AM Demand' (FG1: 'Option 1 AM Demand', Plan 1: 'Network Control Plan 1')**

**Stage Sequence Diagram**

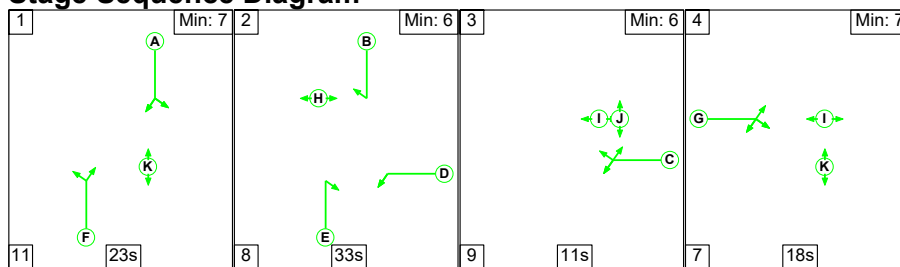

**Stage Timings**

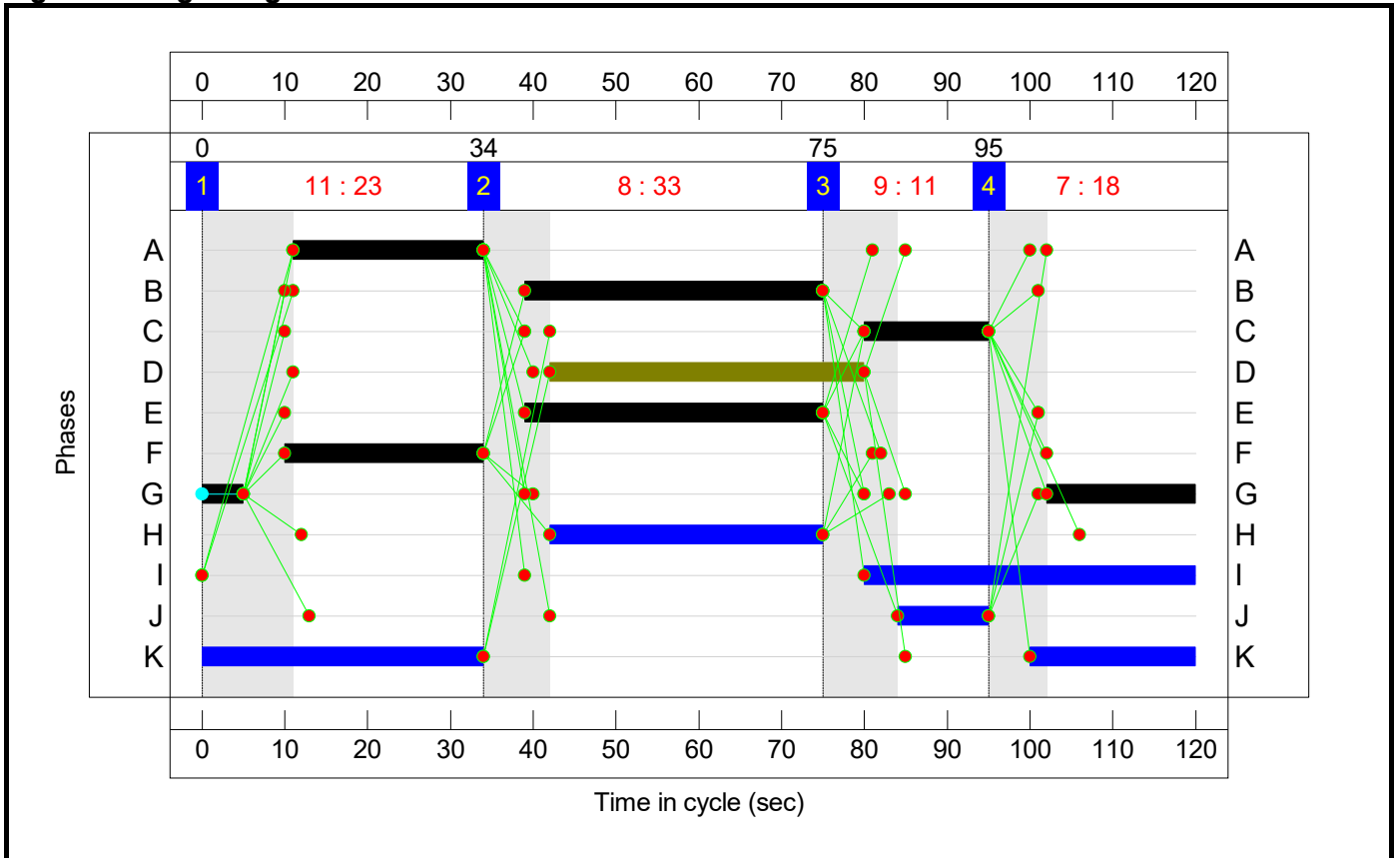

Stage	1	2	3	4
Duration	23	33	11	18
Change Point	0	34	75	95

Signal Timings Diagram

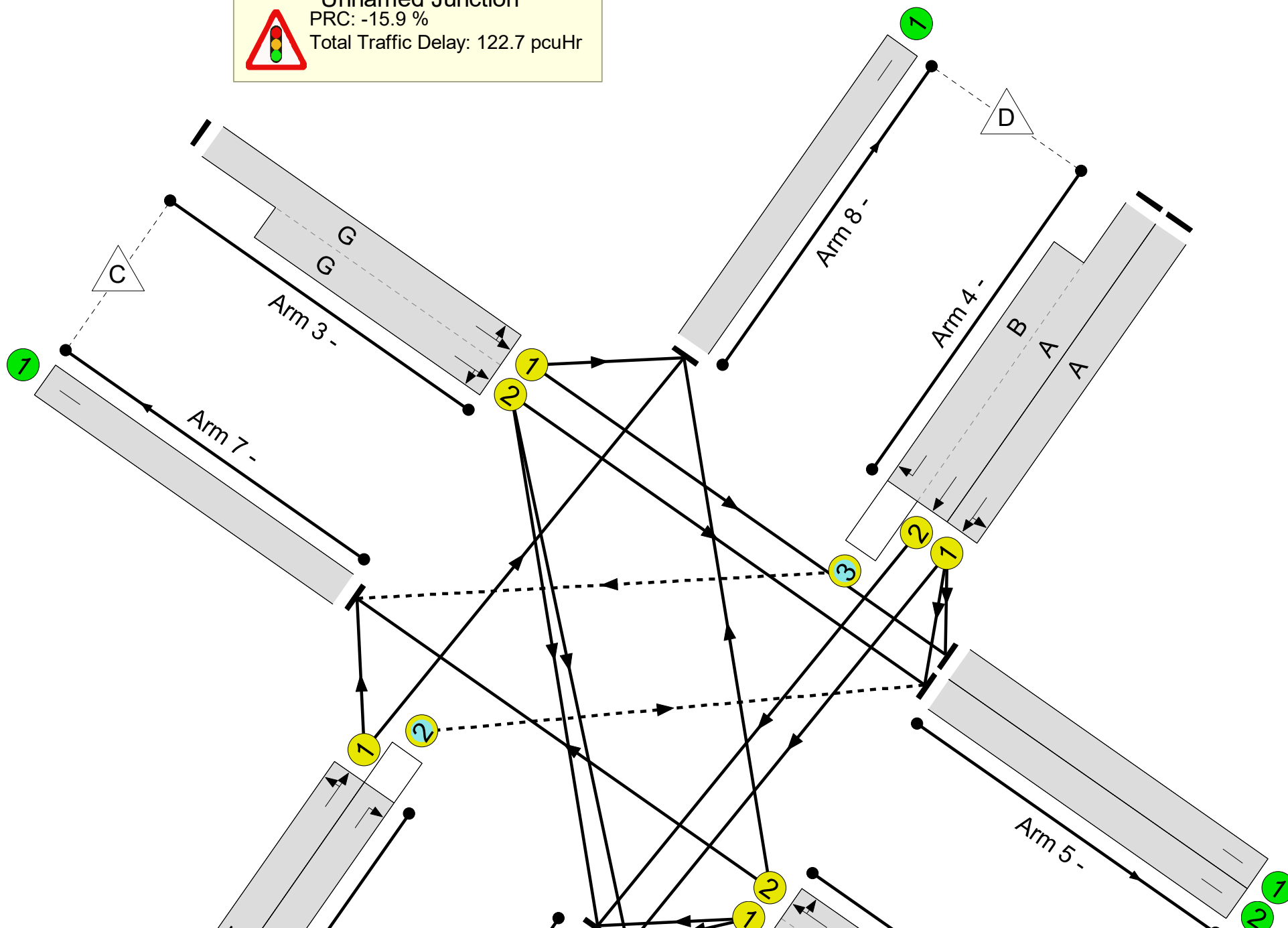

Full Input Data And Results  
**Network Layout Diagram**

Unnamed Junction  
PRC: -15.9 %  
Total Traffic Delay: 122.7 pcuHr



Full Input Data And Results

**Network Results**

Item	Lane Description	Lane Type	Controller Stream	Position In Filtered Route	Full Phase	Arrow Phase	Num Greens	Total Green (s)	Arrow Green (s)	Demand Flow (pcu)	Sat Flow (pcu/Hr)	Capacity (pcu)	Deg Sat (%)
<b>Network</b>	-	-	<b>N/A</b>	-	-		-	-	-	-	-	-	<b>104.3%</b>
<b>Unnamed Junction</b>	-	-	<b>N/A</b>	-	-		-	-	-	-	-	-	<b>104.3%</b>
1/1+1/2	Left Ahead Right	U	N/A	N/A	C	D	1	53:15	38	564	1766:1840	376+165	104.3 : 104.3%
2/1	Left Ahead	U	N/A	N/A	F		1	24	-	433	1993	415	104.3%
2/2	Right	O	N/A	N/A	E		1	36	-	160	1809	558	28.7%
3/1+3/2	Ahead Right Left	U	N/A	N/A	G		1	23	-	506	1773:1984	355+130	104.3 : 104.3%
4/1	Left Ahead	U	N/A	N/A	A		1	23	-	390	1932	386	100.9%
4/2+4/3	Ahead Right	U+O	N/A	N/A	A B		1	23:36	-	753	2093:1765	229+496	103.9 : 103.9%
5/1		U	N/A	N/A	-		-	-	-	19	Inf	Inf	0.0%
5/2		U	N/A	N/A	-		-	-	-	286	Inf	Inf	0.0%
6/1		U	N/A	N/A	-		-	-	-	563	Inf	Inf	0.0%
6/2		U	N/A	N/A	-		-	-	-	448	Inf	Inf	0.0%
7/1		U	N/A	N/A	-		-	-	-	589	Inf	Inf	0.0%
8/1		U	N/A	N/A	-		-	-	-	901	Inf	Inf	0.0%

Full Input Data And Results

Item	Arriving (pcu)	Leaving (pcu)	Turners In Gaps (pcu)	Turners When Unopposed (pcu)	Turners In Intergreen (pcu)	Uniform Delay (pcuHr)	Rand + Oversat Delay (pcuHr)	Storage Area Uniform Delay (pcuHr)	Total Delay (pcuHr)	Av. Delay Per PCU (s/pcu)	Max. Back of Uniform Queue (pcu)	Rand + Oversat Queue (pcu)	Mean Max Queue (pcu)
Network	-	-	0	621	34	36.7	86.0	0.0	122.7	-	-	-	-
Unnamed Junction	-	-	0	621	34	36.7	86.0	0.0	122.7	-	-	-	-
1/1+1/2	564	541	-	-	-	6.3	19.1	-	25.4	162.1	18.3	19.1	37.4
2/1	433	415	-	-	-	6.8	15.8	-	22.5	187.4	15.0	15.8	30.8
2/2	160	160	0	157	3	1.4	0.2	0.0	1.6	36.0	4.0	0.2	4.2
3/1+3/2	506	485	-	-	-	7.3	17.7	-	25.0	177.6	13.4	17.7	31.1
4/1	390	386	-	-	-	5.4	10.8	-	16.2	149.8	13.1	10.8	23.9
4/2+4/3	753	734	0	464	32	9.6	22.4	0.0	32.0	153.0	21.3	22.4	43.7
5/1	19	19	-	-	-	0.0	0.0	-	0.0	0.0	0.0	0.0	0.0
5/2	281	281	-	-	-	0.0	0.0	-	0.0	0.0	0.0	0.0	0.0
6/1	551	551	-	-	-	0.0	0.0	-	0.0	0.0	0.0	0.0	0.0
6/2	439	439	-	-	-	0.0	0.0	-	0.0	0.0	0.0	0.0	0.0
7/1	567	567	-	-	-	0.0	0.0	-	0.0	0.0	0.0	0.0	0.0
8/1	864	864	-	-	-	0.0	0.0	-	0.0	0.0	0.0	0.0	0.0
C1			PRC for Signalled Lanes (%): -15.9			Total Delay for Signalled Lanes (pcuHr): 122.73			122.73	Cycle Time (s): 120			
			PRC Over All Lanes (%): -15.9			Total Delay Over All Lanes(pcuHr):			122.73				

Full Input Data And Results

Scenario 2: 'Option 1 PM Demand' (FG2: 'Option 1 PM Demand', Plan 1: 'Network Control Plan 1')

Stage Sequence Diagram

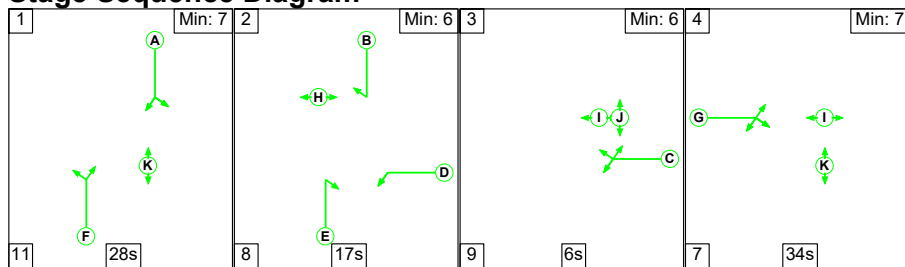

Stage Timings

Stage	1	2	3	4
Duration	28	17	6	34
Change Point	0	39	64	79

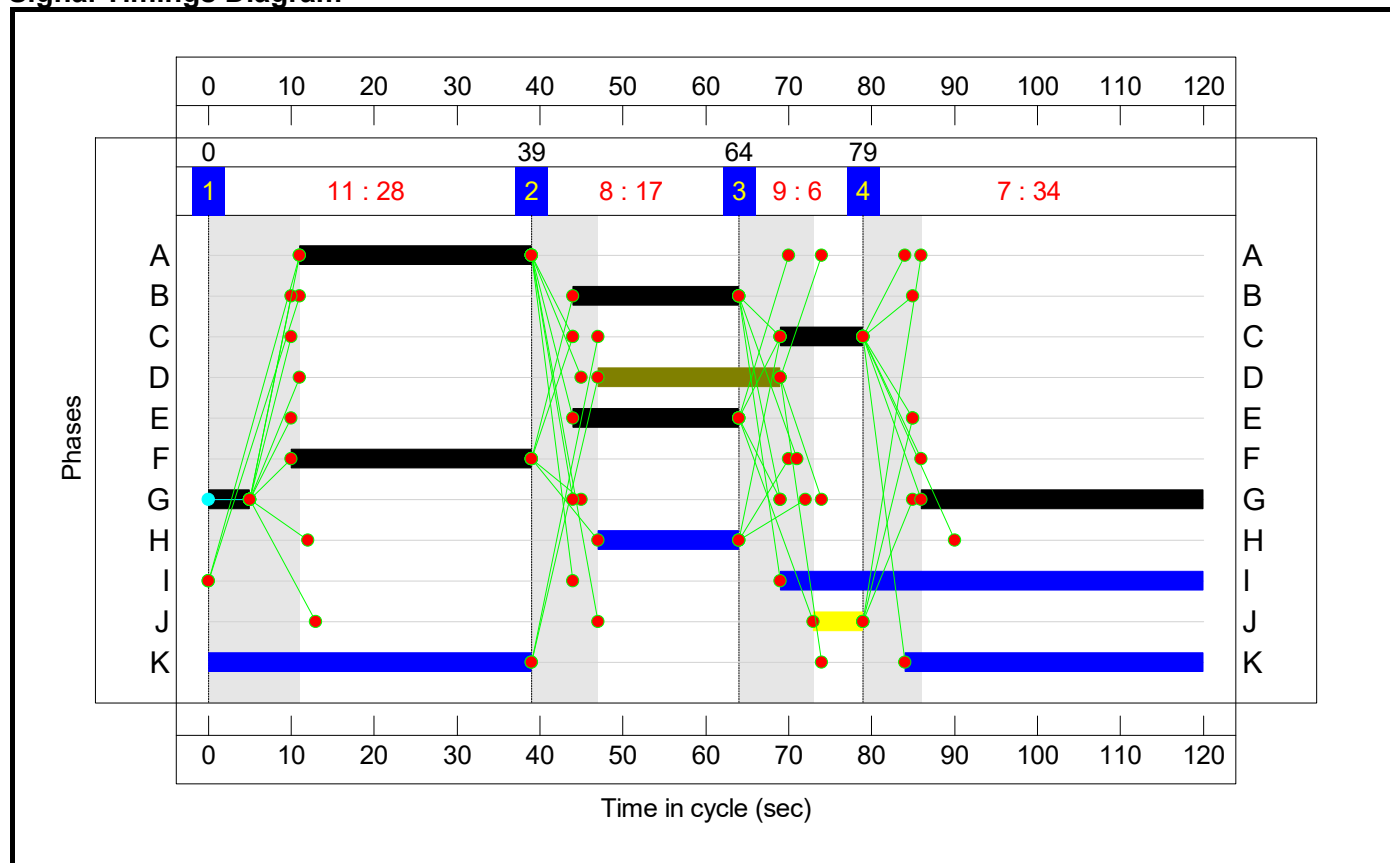

Signal Timings Diagram



Full Input Data And Results  
**Network Layout Diagram**

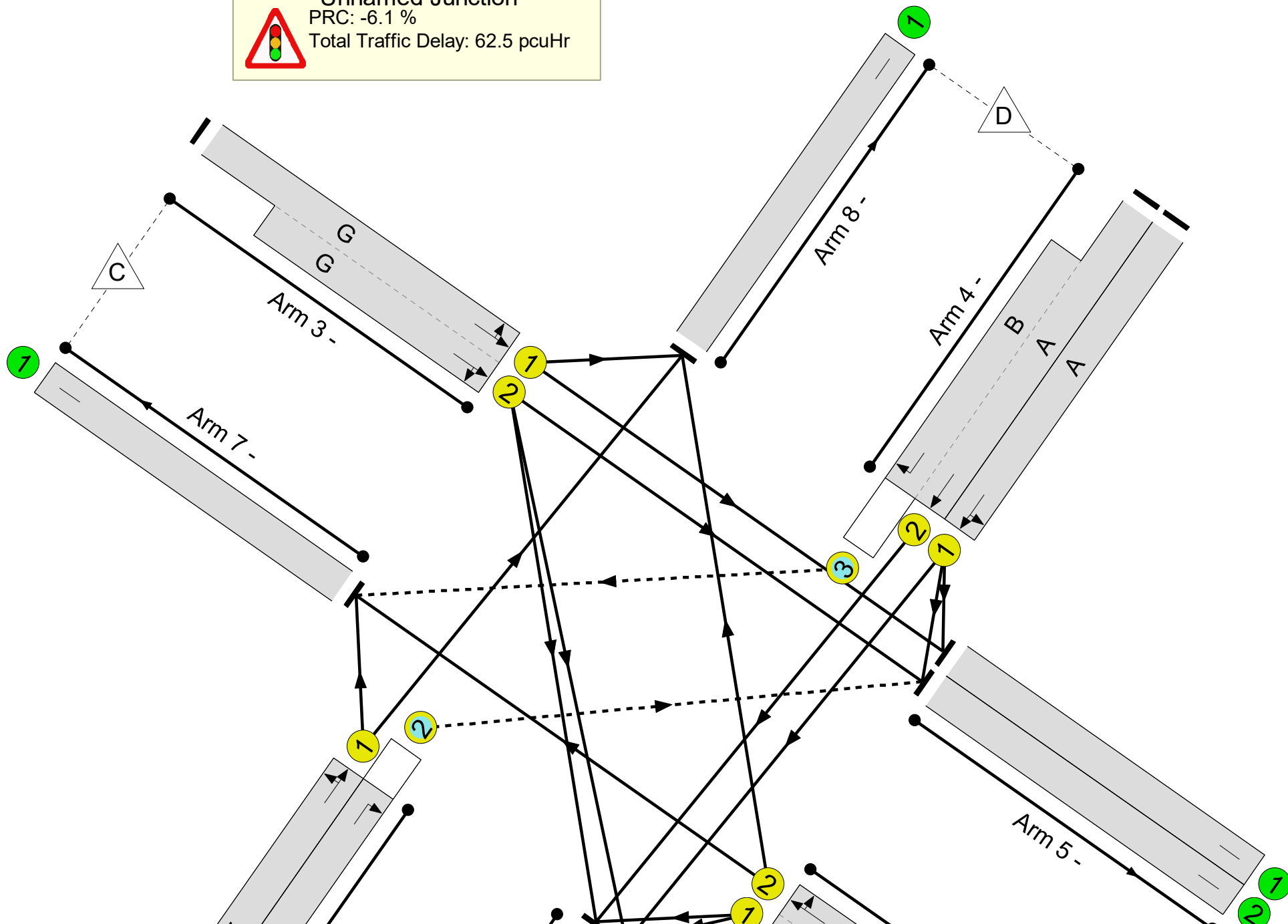

Unnamed Junction  
PRC: -6.1 %  
Total Traffic Delay: 62.5 pcuHr



Full Input Data And Results

**Network Results**

Item	Lane Description	Lane Type	Controller Stream	Position In Filtered Route	Full Phase	Arrow Phase	Num Greens	Total Green (s)	Arrow Green (s)	Demand Flow (pcu)	Sat Flow (pcu/Hr)	Capacity (pcu)	Deg Sat (%)
Network	-	-	N/A	-	-		-	-	-	-	-	-	95.5%
Unnamed Junction	-	-	N/A	-	-		-	-	-	-	-	-	95.5%
1/1+1/2	Left Ahead Right	U	N/A	N/A	C	D	1	32:10	22	483	1766:1822	418+112	91.1 : 91.1%
2/1	Left Ahead	U	N/A	N/A	F		1	29	-	479	2007	502	95.5%
2/2	Right	O	N/A	N/A	E		1	20	-	238	1809	317	75.2%
3/1+3/2	Ahead Right Left	U	N/A	N/A	G		1	39	-	709	1773:1950	528+227	94.0 : 94.0%
4/1	Left Ahead	U	N/A	N/A	A		1	28	-	424	1916	463	91.6%
4/2+4/3	Ahead Right	U+O	N/A	N/A	A B		1	28:20	-	506	2093:1765	226+309	94.5 : 94.5%
5/1		U	N/A	N/A	-		-	-	-	34	Inf	Inf	0.0%
5/2		U	N/A	N/A	-		-	-	-	393	Inf	Inf	0.0%
6/1		U	N/A	N/A	-		-	-	-	593	Inf	Inf	0.0%
6/2		U	N/A	N/A	-		-	-	-	450	Inf	Inf	0.0%
7/1		U	N/A	N/A	-		-	-	-	306	Inf	Inf	0.0%
8/1		U	N/A	N/A	-		-	-	-	1063	Inf	Inf	0.0%

Full Input Data And Results

Item	Arriving (pcu)	Leaving (pcu)	Turners In Gaps (pcu)	Turners When Unopposed (pcu)	Turners In Intergreen (pcu)	Uniform Delay (pcuHr)	Rand + Oversat Delay (pcuHr)	Storage Area Uniform Delay (pcuHr)	Total Delay (pcuHr)	Av. Delay Per PCU (s/pcu)	Max. Back of Uniform Queue (pcu)	Rand + Oversat Queue (pcu)	Mean Max Queue (pcu)
<b>Network</b>	-	-	0	499	31	33.4	29.1	0.0	62.5	-	-	-	-
<b>Unnamed Junction</b>	-	-	0	499	31	33.4	29.1	0.0	62.5	-	-	-	-
1/1+1/2	483	483	-	-	-	5.8	4.3	-	10.2	75.8	14.3	4.3	18.6
2/1	479	479	-	-	-	5.9	6.6	-	12.5	94.3	15.7	6.6	22.3
2/2	238	238	0	234	4	3.1	1.5	0.0	4.6	69.1	7.5	1.5	8.9
3/1+3/2	709	709	-	-	-	7.1	6.1	-	13.2	67.0	17.8	6.1	23.9
4/1	424	424	-	-	-	5.2	4.4	-	9.6	81.9	13.7	4.4	18.1
4/2+4/3	506	506	0	265	27	6.3	6.1	0.0	12.4	87.9	9.6	6.1	15.7
5/1	34	34	-	-	-	0.0	0.0	-	0.0	0.0	0.0	0.0	0.0
5/2	393	393	-	-	-	0.0	0.0	-	0.0	0.0	0.0	0.0	0.0
6/1	593	593	-	-	-	0.0	0.0	-	0.0	0.0	0.0	0.0	0.0
6/2	450	450	-	-	-	0.0	0.0	-	0.0	0.0	0.0	0.0	0.0
7/1	306	306	-	-	-	0.0	0.0	-	0.0	0.0	0.0	0.0	0.0
8/1	1063	1063	-	-	-	0.0	0.0	-	0.0	0.0	0.0	0.0	0.0
C1			PRC for Signalled Lanes (%):		-6.1	Total Delay for Signalled Lanes (pcuHr):		62.49	Cycle Time (s): 120				
			PRC Over All Lanes (%):		-6.1	Total Delay Over All Lanes(pcuHr):		62.49					

Full Input Data And Results

Scenario 3: 'Option 2 AM Demand' (FG3: 'Option 2 AM Demand', Plan 1: 'Network Control Plan 1')

Stage Sequence Diagram

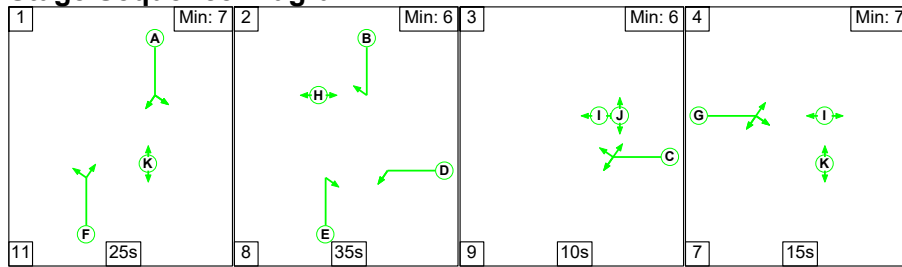

Stage Timings

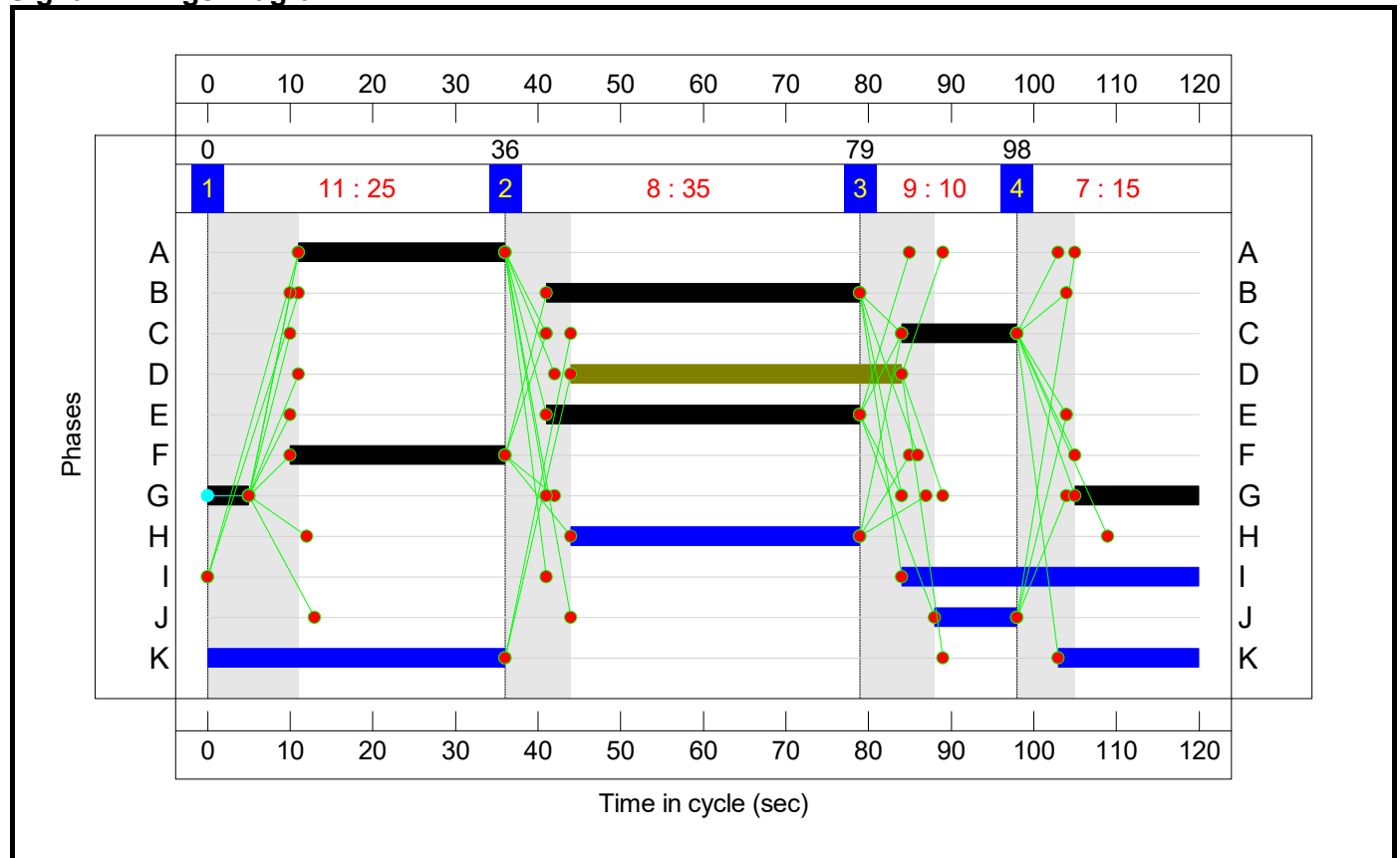

Stage	1	2	3	4
Duration	25	35	10	15
Change Point	0	36	79	98

Signal Timings Diagram

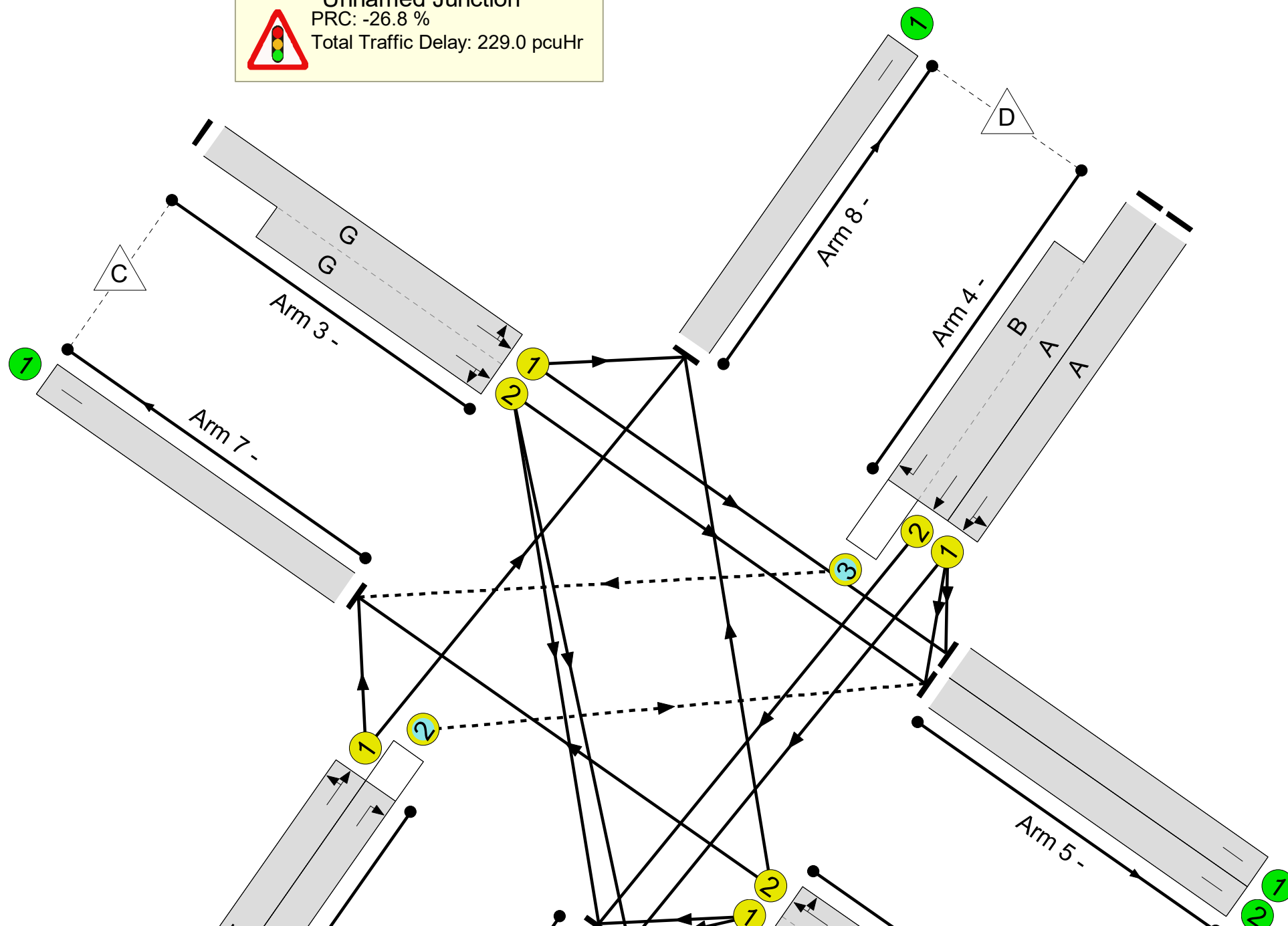

Full Input Data And Results  
**Network Layout Diagram**

Unnamed Junction  
PRC: -26.8 %  
Total Traffic Delay: 229.0 pcuHr



Full Input Data And Results

**Network Results**

Item	Lane Description	Lane Type	Controller Stream	Position In Filtered Route	Full Phase	Arrow Phase	Num Greens	Total Green (s)	Arrow Green (s)	Demand Flow (pcu)	Sat Flow (pcu/Hr)	Capacity (pcu)	Deg Sat (%)
<b>Network</b>	-	-	<b>N/A</b>	-	-		-	-	-	-	-	-	<b>114.1%</b>
<b>Unnamed Junction</b>	-	-	<b>N/A</b>	-	-		-	-	-	-	-	-	<b>114.1%</b>
1/1+1/2	Left Ahead Right	U	N/A	N/A	C	D	1	54:14	40	586	1766:1839	352+161	114.1 : 114.1%
2/1	Left Ahead	U	N/A	N/A	F		1	26	-	510	1987	447	114.1%
2/2	Right	O	N/A	N/A	E		1	38	-	163	1809	588	27.7%
3/1+3/2	Ahead Right Left	U	N/A	N/A	G		1	20	-	481	1773:1980	310+121	111.5 : 111.5%
4/1	Left Ahead	U	N/A	N/A	A		1	25	-	460	1920	416	110.6%
4/2+4/3	Ahead Right	U+O	N/A	N/A	A B		1	25:38	-	784	2093:1765	167+529	112.6 : 112.6%
5/1		U	N/A	N/A	-		-	-	-	34	Inf	Inf	0.0%
5/2		U	N/A	N/A	-		-	-	-	300	Inf	Inf	0.0%
6/1		U	N/A	N/A	-		-	-	-	610	Inf	Inf	0.0%
6/2		U	N/A	N/A	-		-	-	-	404	Inf	Inf	0.0%
7/1		U	N/A	N/A	-		-	-	-	691	Inf	Inf	0.0%
8/1		U	N/A	N/A	-		-	-	-	945	Inf	Inf	0.0%

Full Input Data And Results

Item	Arriving (pcu)	Leaving (pcu)	Turners In Gaps (pcu)	Turners When Unopposed (pcu)	Turners In Intergreen (pcu)	Uniform Delay (pcuHr)	Rand + Oversat Delay (pcuHr)	Storage Area Uniform Delay (pcuHr)	Total Delay (pcuHr)	Av. Delay Per PCU (s/pcu)	Max. Back of Uniform Queue (pcu)	Rand + Oversat Queue (pcu)	Mean Max Queue (pcu)
<b>Network</b>	-	-	<b>0</b>	<b>655</b>	<b>38</b>	<b>50.5</b>	<b>178.5</b>	<b>0.0</b>	<b>229.0</b>	-	-	-	-
<b>Unnamed Junction</b>	-	-	<b>0</b>	<b>655</b>	<b>38</b>	<b>50.5</b>	<b>178.5</b>	<b>0.0</b>	<b>229.0</b>	-	-	-	-
1/1+1/2	586	513	-	-	-	8.6	40.0	-	48.6	298.4	20.6	40.0	60.6
2/1	510	447	-	-	-	10.3	35.1	-	45.4	320.8	19.1	35.1	54.2
2/2	163	163	0	160	3	1.4	0.2	0.0	1.6	34.3	4.0	0.2	4.2
3/1+3/2	481	431	-	-	-	8.9	29.0	-	37.9	283.8	13.5	29.0	42.5
4/1	460	416	-	-	-	8.6	26.4	-	35.0	273.8	16.8	26.4	43.2
4/2+4/3	784	696	0	495	35	12.7	47.9	0.0	60.5	278.0	28.0	47.9	75.9
5/1	31	31	-	-	-	0.0	0.0	-	0.0	0.0	0.0	0.0	0.0
5/2	286	286	-	-	-	0.0	0.0	-	0.0	0.0	0.0	0.0	0.0
6/1	546	546	-	-	-	0.0	0.0	-	0.0	0.0	0.0	0.0	0.0
6/2	357	357	-	-	-	0.0	0.0	-	0.0	0.0	0.0	0.0	0.0
7/1	613	613	-	-	-	0.0	0.0	-	0.0	0.0	0.0	0.0	0.0
8/1	835	835	-	-	-	0.0	0.0	-	0.0	0.0	0.0	0.0	0.0
C1			PRC for Signalled Lanes (%): -26.8		PRC Over All Lanes (%): -26.8		Total Delay for Signalled Lanes (pcuHr): 229.01		229.01	Cycle Time (s): 120			
							Total Delay Over All Lanes(pcuHr):		229.01				



Full Input Data And Results

Scenario 4: 'Option 2 PM Demand' (FG4: 'Option 2 PM Demand', Plan 1: 'Network Control Plan 1')

Stage Sequence Diagram

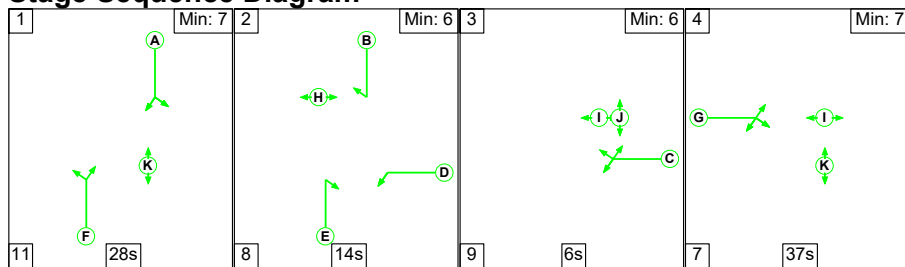

Stage Timings

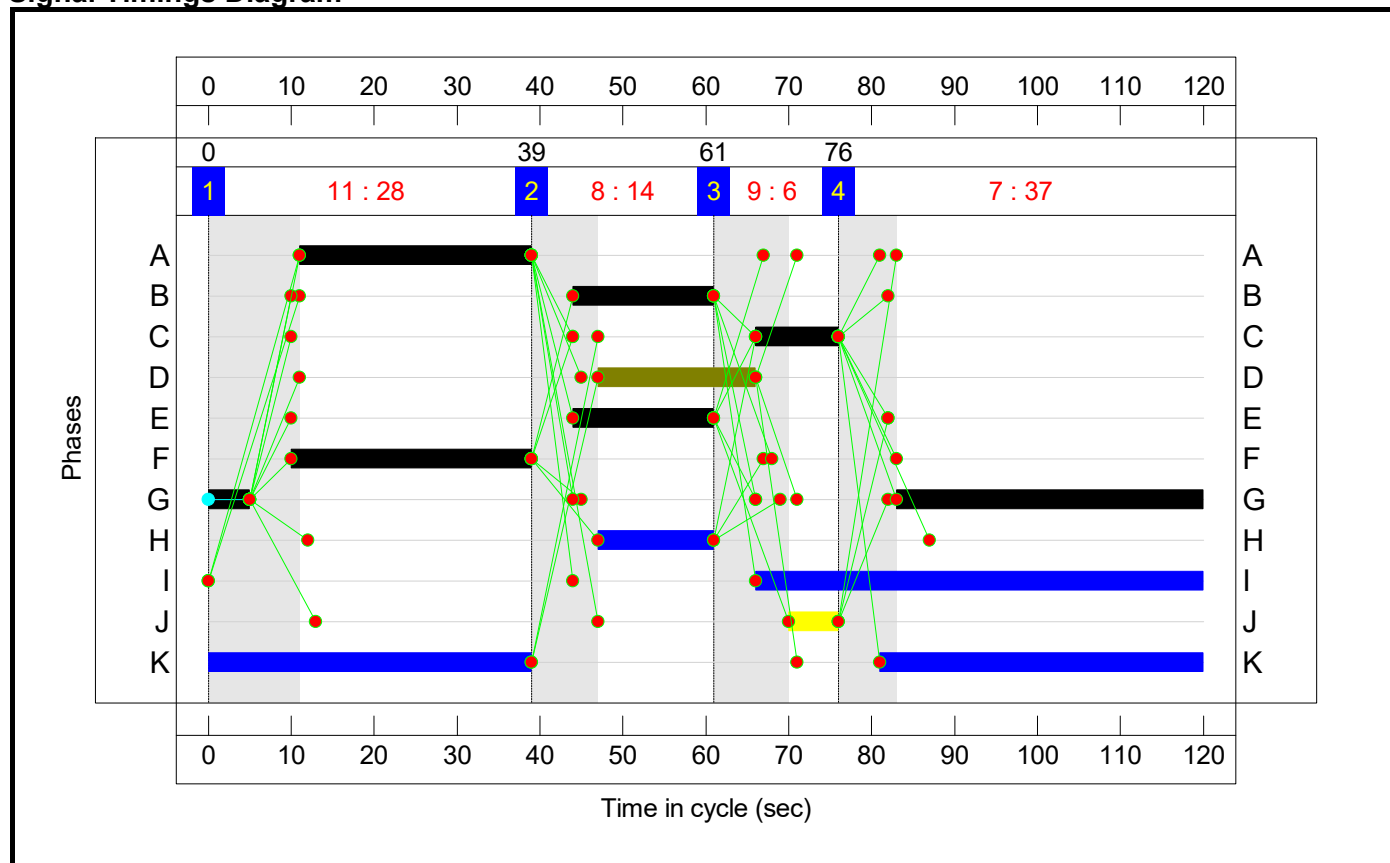

Stage	1	2	3	4
Duration	28	14	6	37
Change Point	0	39	61	76

Signal Timings Diagram

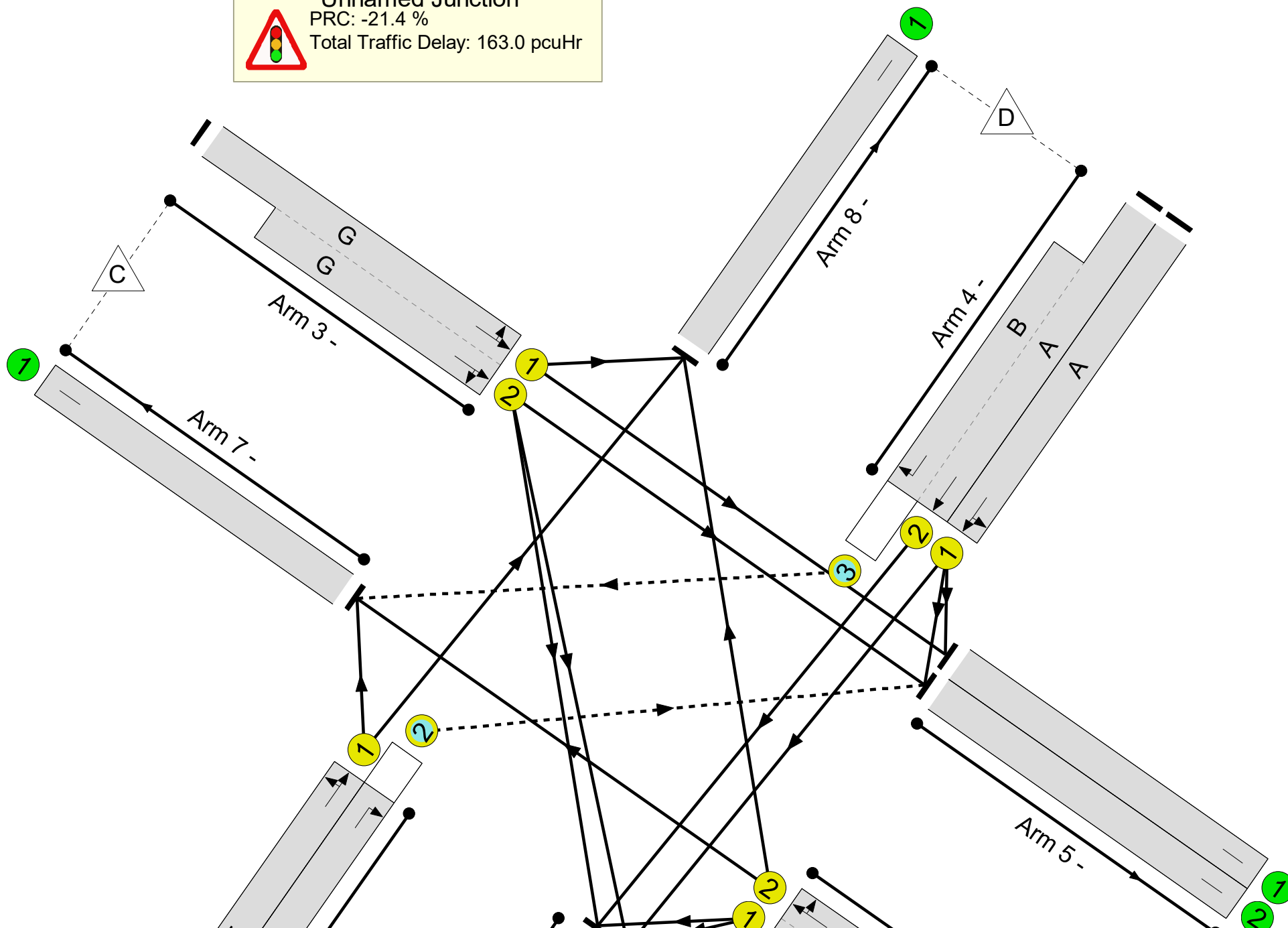

Full Input Data And Results  
**Network Layout Diagram**

Unnamed Junction  
PRC: -21.4 %  
Total Traffic Delay: 163.0 pcuHr



Full Input Data And Results

**Network Results**



Item	Lane Description	Lane Type	Controller Stream	Position In Filtered Route	Full Phase	Arrow Phase	Num Greens	Total Green (s)	Arrow Green (s)	Demand Flow (pcu)	Sat Flow (pcu/Hr)	Capacity (pcu)	Deg Sat (%)
<b>Network</b>	-	-	<b>N/A</b>	-	-		-	-	-	-	-	-	<b>109.3%</b>
<b>Unnamed Junction</b>	-	-	<b>N/A</b>	-	-		-	-	-	-	-	-	<b>109.3%</b>
1/1+1/2	Left Ahead Right	U	N/A	N/A	C	D	1	29:10	19	488	1766:1820	388+94	101.2 : 101.2%
2/1	Left Ahead	U	N/A	N/A	F		1	29	-	543	1988	497	109.3%
2/2	Right	O	N/A	N/A	E		1	17	-	244	1809	271	89.9%
3/1+3/2	Ahead Right Left	U	N/A	N/A	G		1	42	-	872	1773:1953	558+245	108.5 : 108.5%
4/1	Left Ahead	U	N/A	N/A	A		1	28	-	482	1921	464	103.8%
4/2+4/3	Ahead Right	U+O	N/A	N/A	A B		1	28:17	-	451	2093:1765	165+265	105.0 : 105.0%
5/1		U	N/A	N/A	-		-	-	-	34	Inf	Inf	0.0%
5/2		U	N/A	N/A	-		-	-	-	435	Inf	Inf	0.0%
6/1		U	N/A	N/A	-		-	-	-	666	Inf	Inf	0.0%
6/2		U	N/A	N/A	-		-	-	-	423	Inf	Inf	0.0%
7/1		U	N/A	N/A	-		-	-	-	337	Inf	Inf	0.0%
8/1		U	N/A	N/A	-		-	-	-	1185	Inf	Inf	0.0%

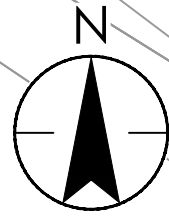

**Appendix B**  
**Woodgate Corner Potential Junction Improvements 1 Modelling Results**



**KEY:**

-  EXISTING LAYOUT
-  POTENTIAL MITIGATION
-  HIGHWAY BOUNDARY

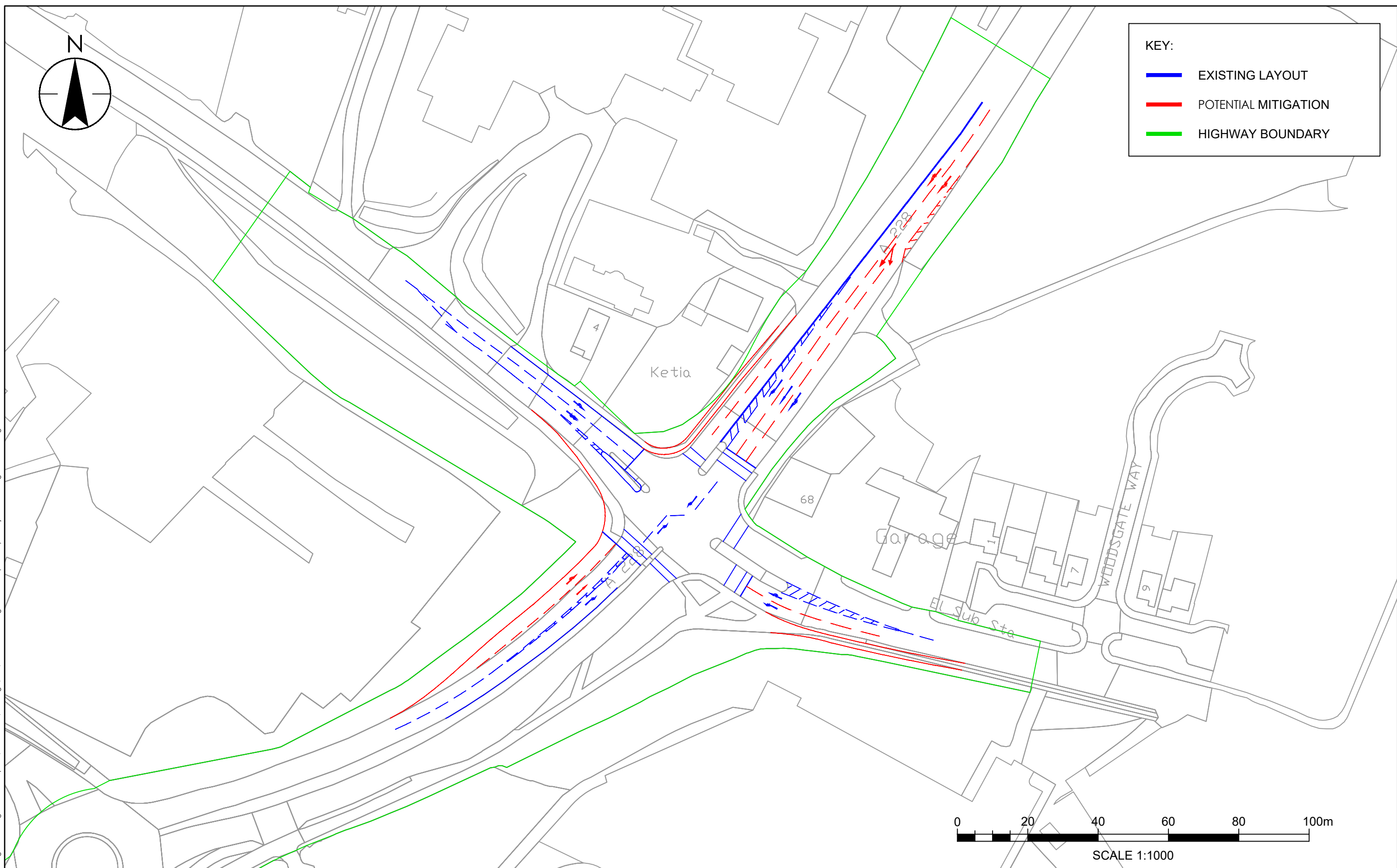

Plotted: 27.06.2024 06:27 8:43:02 AM By: Smith, Daniel  
ORIGINAL SHEET - ISCA3  
p:\332611481 - gh - tunbridge wells local plan\3-autocad\drawings\100\332611481-str-hgn-h-0003a - pembury road junctions mitigation - woodgate corner



**Stantec**  
Stantec UK Limited  
Unit 10, Connect 38, 1 Dover Place  
Ashford  
TN23 1FB  
Tel: +44 1233 527 250  
www.stantec.com/uk

### S2 FOR INFORMATION

Client/Project:  
TWBC  
TUNBRIDGE WELLS  
LOCAL PLAN  
Project No.:  
332611481

Title  
PEMBURY ROAD POTENTIAL  
MITIGATION SCHEME -  
WOODGATE CORNER

Revision: A	Date: 2024.06.27	Drawing No. 0003
----------------	---------------------	---------------------

**Appendix C**  
**Woodgate Corner Proposed Junction Improvements 2 Drawing**



Full Input Data And Results  
**Full Input Data And Results**

**User and Project Details**

<b>Project:</b>	
<b>Title:</b>	
<b>Location:</b>	
<b>Additional detail:</b>	
<b>File name:</b>	Woodgate Corner (Mitigation Layout) - Retained Ped Crossings.lsg3x
<b>Author:</b>	
<b>Company:</b>	
<b>Address:</b>	

### Network Layout Diagram

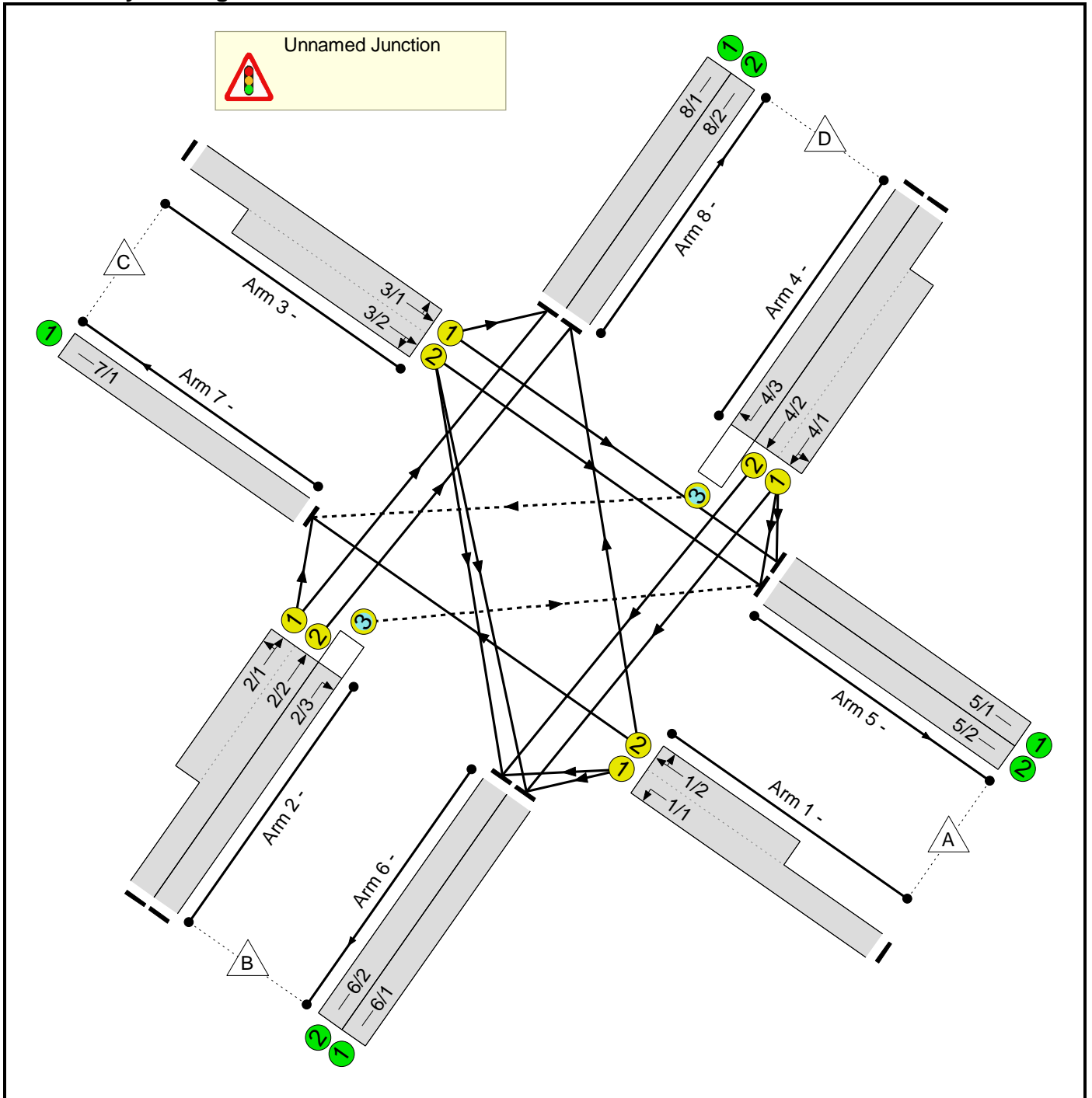

Phase Diagram

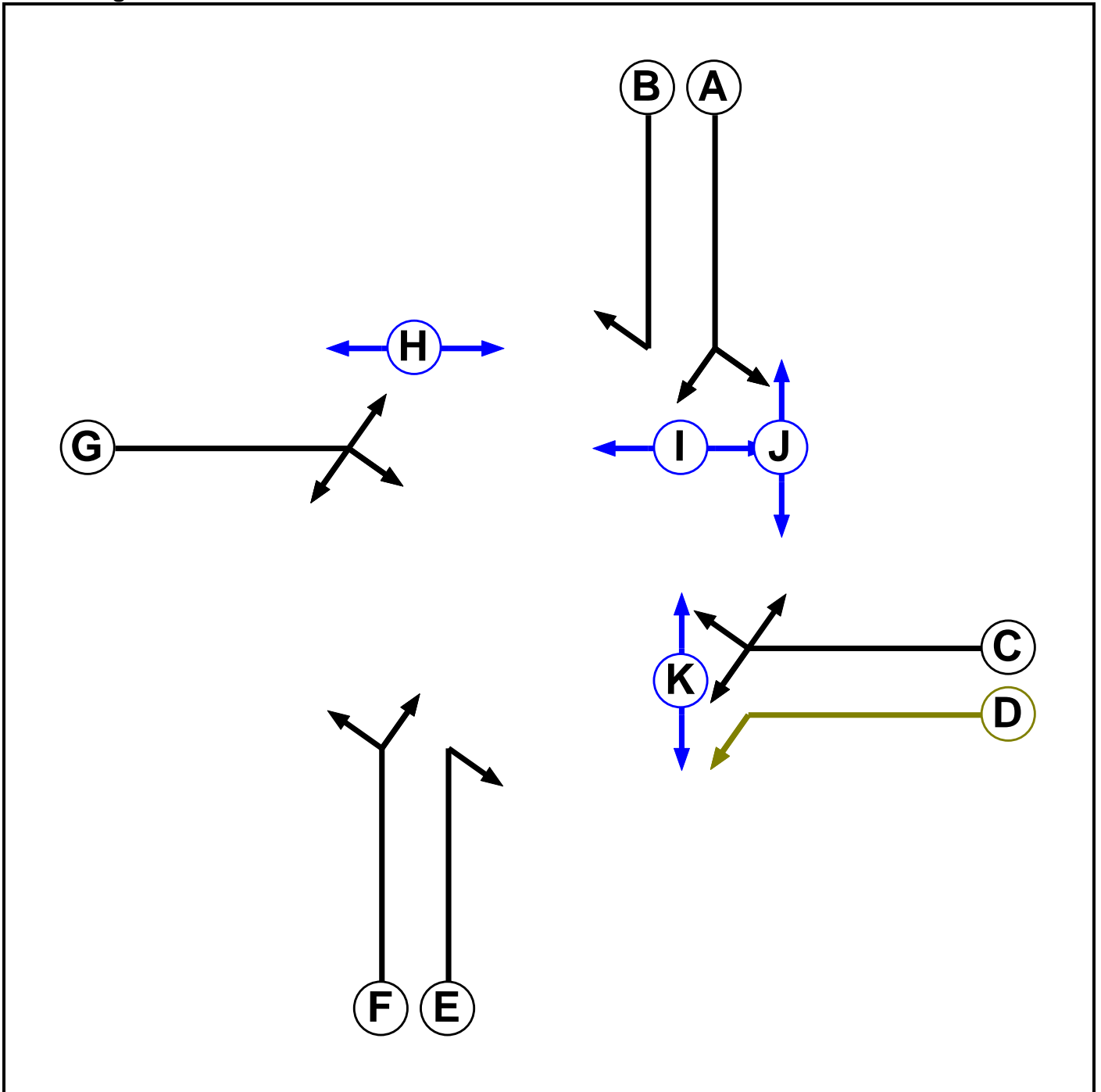

# Full Input Data And Results

## Phase Input Data

Phase Name	Phase Type	Assoc. Phase	Street Min	Cont Min
A	Traffic		7	7
B	Traffic		7	7
C	Traffic		7	7
D	Filter	C	1	0
E	Traffic		7	7
F	Traffic		7	7
G	Traffic		7	7
H	Pedestrian		6	6
I	Pedestrian		6	6
J	Pedestrian		6	6
K	Pedestrian		6	6

## Phase Intergreens Matrix

		Starting Phase										
		A	B	C	D	E	F	G	H	I	J	K
Terminating Phase	A	-	5	6	5	-	5	-	5	8	-	-
	B	-	-	5	-	-	7	5	-	5	-	-
	C	5	6	-	6	7	7	11	-	-	-	5
	D	5	-	-	-	-	5	-	-	-	-	5
	E	6	-	5	-	-	5	-	-	9	-	-
	F	-	5	5	-	-	6	8	-	-	-	-
	G	6	5	5	6	5	5	7	-	8	-	-
	H	-	-	8	-	-	8	8	-	-	-	-
	I	11	11	-	-	-	-	-	-	-	-	-
	J	7	-	-	-	6	-	6	-	-	-	-
	K	-	-	8	8	-	-	-	-	-	-	-

## Phases in Stage

Stage No.	Phases in Stage
1	A F K
2	B D E H
3	C I J
4	G I K

## Stage Diagram

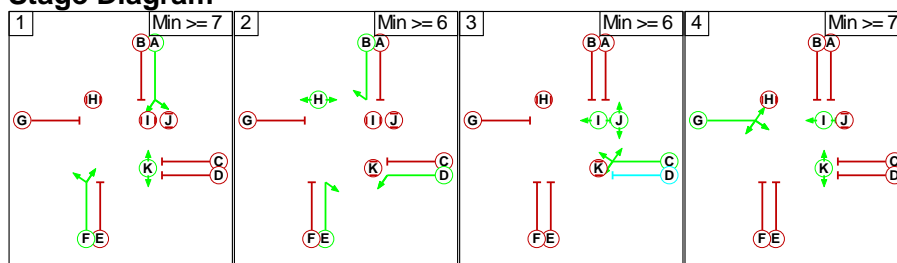

## Full Input Data And Results

### Phase Delays

Term. Stage	Start Stage	Phase	Type	Value	Cont value
4	1	G	Losing	5	5

### Prohibited Stage Change

		To Stage			
		1	2	3	4
From Stage	1	8	8	6	
	2	X	9	X	
	3	11	11	7	
	4	11	11	8	

Full Input Data And Results

**Give-Way Lane Input Data**

Junction: Unnamed Junction											
Lane	Movement	Max Flow when Giving Way (PCU/Hr)	Min Flow when Giving Way (PCU/Hr)	Opposing Lane	Opp. Lane Coeff.	Opp. Mvmnts.	Right Turn Storage (PCU)	Non-Blocking Storage (PCU)	RTF	Right Turn Move up (s)	Max Turns in Intergreen (PCU)
2/3	5/2 (Right)	1439	0	4/1	1.09	All	2.00	-	0.50	2	2.00
				4/2		All					
4/3	7/1 (Right)	1439	0	2/2	1.09	All	3.00	-	0.50	3	3.00

Full Input Data And Results

**Lane Input Data**

Junction: Unnamed Junction												
Lane	Lane Type	Phases	Start Disp.	End Disp.	Physical Length (PCU)	Sat Flow Type	Def User Saturation Flow (PCU/Hr)	Lane Width (m)	Gradient	Nearside Lane	Turns	Turning Radius (m)
1/1	U	C D	2	3	60.0	Geom	-	3.34	0.00	Y	Arm 6 Left	14.50
1/2	U	C	2	3	8.7	Geom	-	3.34	0.00	Y	Arm 7 Ahead	Inf
											Arm 8 Right	18.50
2/1	U	F	2	3	8.7	Geom	-	3.92	0.00	Y	Arm 7 Left	13.50
											Arm 8 Ahead	Inf
2/2	U	F	2	3	27.8	Geom	-	3.92	0.00	Y	Arm 8 Ahead	Inf
2/3	O	E	2	3	27.8	Geom	-	4.30	0.00	Y	Arm 5 Right	11.50
3/1	U	G	2	3	60.0	Geom	-	4.12	0.00	Y	Arm 5 Ahead	Inf
											Arm 8 Left	10.50
3/2	U	G	2	3	11.3	Geom	-	4.01	0.00	Y	Arm 5 Ahead	Inf
											Arm 6 Right	19.00
4/1	U	A	2	3	13.0	Geom	-	3.41	0.00	Y	Arm 5 Left	11.50
											Arm 6 Ahead	Inf
4/2	U	A	2	3	60.0	Geom	-	3.38	0.00	N	Arm 6 Ahead	Inf
4/3	O	B	2	3	60.0	Geom	-	3.21	0.00	Y	Arm 7 Right	15.50
5/1	U		2	3	60.0	Inf	-	-	-	-	-	-
5/2	U		2	3	60.0	Inf	-	-	-	-	-	-
6/1	U		2	3	60.0	Inf	-	-	-	-	-	-
6/2	U		2	3	60.0	Inf	-	-	-	-	-	-
7/1	U		2	3	60.0	Inf	-	-	-	-	-	-
8/1	U		2	3	60.0	Inf	-	-	-	-	-	-
8/2	U		2	3	60.0	Inf	-	-	-	-	-	-

**Traffic Flow Groups**

Flow Group	Start Time	End Time	Duration	Formula
1: 'Option 1 AM Demand'	08:00	09:00	01:00	
2: 'Option 1 PM Demand'	17:00	18:00	01:00	
3: 'Option 2 AM Demand'	08:00	09:00	01:00	
4: 'Option 2 PM Demand'	17:00	18:00	01:00	
5: 'Option 1 AM Actual'	08:00	09:00	01:00	
6: 'Option 1 PM Actual'	17:00	18:00	01:00	
7: 'Option 2 AM Actual'	08:00	09:00	01:00	
8: 'Option 2 PM Actual'	17:00	18:00	01:00	

Full Input Data And Results

**Scenario 1: 'Option 2 AM Demand'** (FG3: 'Option 2 AM Demand', Plan 1: 'Network Control Plan 1')

**Traffic Flows, Desired**

**Desired Flow :**

	Destination					
		A	B	C	D	Tot.
Origin	A	0	402	48	136	586
	B	163	0	47	463	673
	C	104	31	0	346	481
	D	67	581	596	0	1244
	Tot.	334	1014	691	945	2984

**Traffic Lane Flows**

Lane	Scenario 1: Option 2 AM Demand
<b>Junction: Unnamed Junction</b>	
1/1 (with short)	586(In) 402(Out)
1/2 (short)	184
2/1 (short)	252
2/2 (with short)	510(In) 258(Out)
2/3	163
3/1 (with short)	481(In) 346(Out)
3/2 (short)	135
4/1 (short)	309
4/2 (with short)	648(In) 339(Out)
4/3	596
5/1	34
5/2	300
6/1	459
6/2	555
7/1	691
8/1	551
8/2	394



Full Input Data And Results

**Lane Saturation Flows**

Junction: Unnamed Junction								
Lane	Lane Width (m)	Gradient	Nearside Lane	Allowed Turns	Turning Radius (m)	Turning Prop.	Sat Flow (PCU/Hr)	Flared Sat Flow (PCU/Hr)
1/1	3.34	0.00	Y	Arm 6 Left	14.50	100.0 %	1766	1766
1/2	3.34	0.00	Y	Arm 7 Ahead	Inf	26.1 %	1839	1839
				Arm 8 Right	18.50	73.9 %		
2/1	3.92	0.00	Y	Arm 7 Left	13.50	18.7 %	1966	1966
				Arm 8 Ahead	Inf	81.3 %		
2/2	3.92	0.00	Y	Arm 8 Ahead	Inf	100.0 %	2007	2007
2/3	4.30	0.00	Y	Arm 5 Right	11.50	100.0 %	1809	1809
3/1	4.12	0.00	Y	Arm 5 Ahead	Inf	0.0 %	1774	1774
				Arm 8 Left	10.50	100.0 %		
3/2	4.01	0.00	Y	Arm 5 Ahead	Inf	77.0 %	1980	1980
				Arm 6 Right	19.00	23.0 %		
4/1	3.41	0.00	Y	Arm 5 Left	11.50	21.7 %	1902	1902
				Arm 6 Ahead	Inf	78.3 %		
4/2	3.38	0.00	N	Arm 6 Ahead	Inf	100.0 %	2093	2093
4/3	3.21	0.00	Y	Arm 7 Right	15.50	100.0 %	1765	1765
5/1	Infinite Saturation Flow						Inf	Inf
5/2	Infinite Saturation Flow						Inf	Inf
6/1	Infinite Saturation Flow						Inf	Inf
6/2	Infinite Saturation Flow						Inf	Inf
7/1	Infinite Saturation Flow						Inf	Inf
8/1	Infinite Saturation Flow						Inf	Inf
8/2	Infinite Saturation Flow						Inf	Inf

**Scenario 2: 'Option 2 PM Demand'** (FG4: 'Option 2 PM Demand', Plan 1: 'Network Control Plan 1')

**Traffic Flows, Desired**

**Desired Flow :**

Origin	Destination					
	A	B	C	D	Tot.	
A	0	393	12	83	488	
B	244	0	47	496	787	
C	158	108	0	606	872	
D	67	588	278	0	933	
Tot.	469	1089	337	1185	3080	

Full Input Data And Results

**Traffic Lane Flows**

Lane	Scenario 2: Option 2 PM Demand
<b>Junction: Unnamed Junction</b>	
1/1 (with short)	488(In) 393(Out)
1/2 (short)	95
2/1 (short)	269
2/2 (with short)	543(In) 274(Out)
2/3	244
3/1 (with short)	872(In) 606(Out)
3/2 (short)	266
4/1 (short)	312
4/2 (with short)	655(In) 343(Out)
4/3	278
5/1	34
5/2	435
6/1	496
6/2	593
7/1	337
8/1	828
8/2	357

Full Input Data And Results

**Lane Saturation Flows**

Junction: Unnamed Junction								
Lane	Lane Width (m)	Gradient	Nearside Lane	Allowed Turns	Turning Radius (m)	Turning Prop.	Sat Flow (PCU/Hr)	Flared Sat Flow (PCU/Hr)
1/1	3.34	0.00	Y	Arm 6 Left	14.50	100.0 %	1766	1766
1/2	3.34	0.00	Y	Arm 7 Ahead	Inf	12.6 %	1820	1820
				Arm 8 Right	18.50	87.4 %		
2/1	3.92	0.00	Y	Arm 7 Left	13.50	17.5 %	1969	1969
				Arm 8 Ahead	Inf	82.5 %		
2/2	3.92	0.00	Y	Arm 8 Ahead	Inf	100.0 %	2007	2007
2/3	4.30	0.00	Y	Arm 5 Right	11.50	100.0 %	1809	1809
3/1	4.12	0.00	Y	Arm 5 Ahead	Inf	0.0 %	1774	1774
				Arm 8 Left	10.50	100.0 %		
3/2	4.01	0.00	Y	Arm 5 Ahead	Inf	59.4 %	1953	1953
				Arm 6 Right	19.00	40.6 %		
4/1	3.41	0.00	Y	Arm 5 Left	11.50	21.5 %	1903	1903
				Arm 6 Ahead	Inf	78.5 %		
4/2	3.38	0.00	N	Arm 6 Ahead	Inf	100.0 %	2093	2093
4/3	3.21	0.00	Y	Arm 7 Right	15.50	100.0 %	1765	1765
5/1	Infinite Saturation Flow						Inf	Inf
5/2	Infinite Saturation Flow						Inf	Inf
6/1	Infinite Saturation Flow						Inf	Inf
6/2	Infinite Saturation Flow						Inf	Inf
7/1	Infinite Saturation Flow						Inf	Inf
8/1	Infinite Saturation Flow						Inf	Inf
8/2	Infinite Saturation Flow						Inf	Inf

**Scenario 1: 'Option 2 AM Demand'** (FG3: 'Option 2 AM Demand', Plan 1: 'Network Control Plan 1')

**Stage Sequence Diagram**

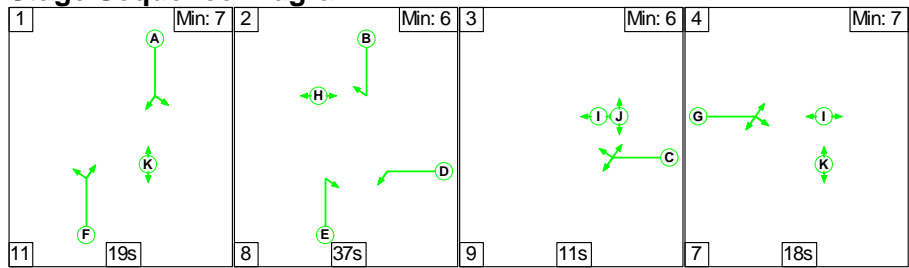

**Stage Timings**

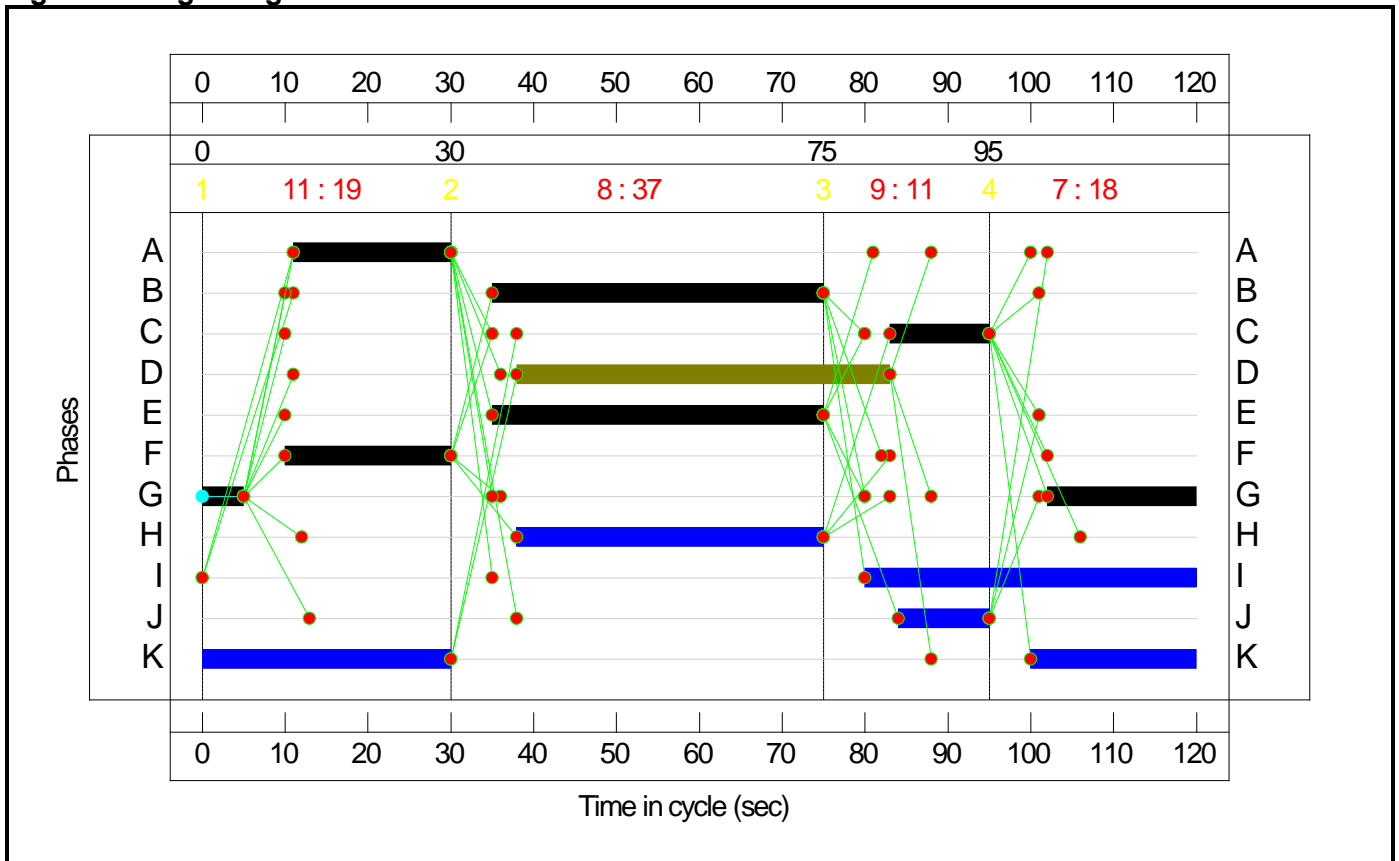

Stage	1	2	3	4
Duration	19	37	11	18
Change Point	0	30	75	95

Signal Timings Diagram

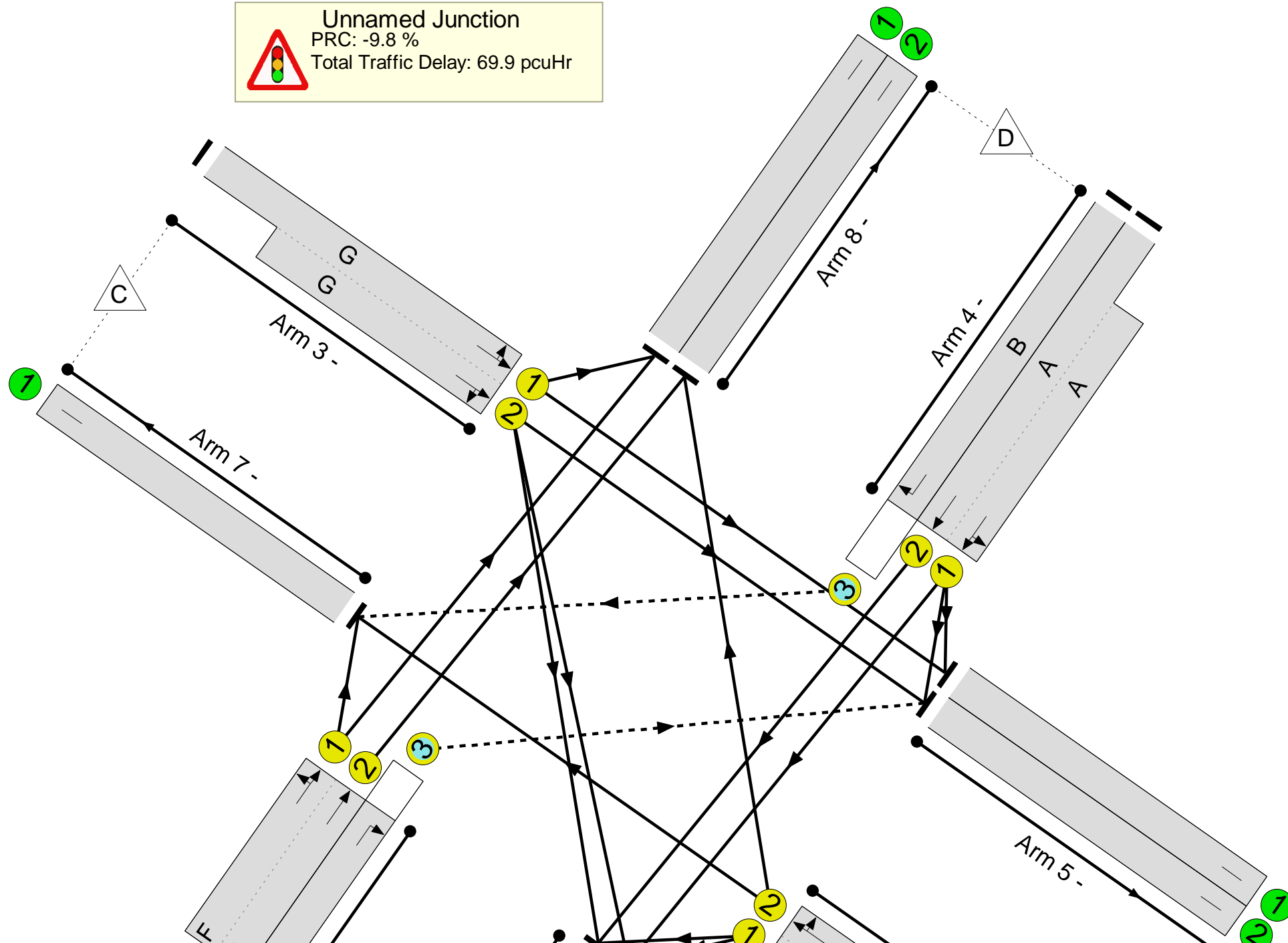

Full Input Data And Results  
**Network Layout Diagram**

Unnamed Junction  
PRC: -9.8 %  
Total Traffic Delay: 69.9 pcuHr



Full Input Data And Results

**Network Results**

Item	Lane Description	Lane Type	Controller Stream	Position In Filtered Route	Full Phase	Arrow Phase	Num Greens	Total Green (s)	Arrow Green (s)	Demand Flow (pcu)	Sat Flow (pcu/Hr)	Capacity (pcu)	Deg Sat (%)
<b>Network</b>	-	-	<b>N/A</b>	-	-		-	-	-	-	-	-	<b>98.8%</b>
<b>Unnamed Junction</b>	-	-	<b>N/A</b>	-	-		-	-	-	-	-	-	<b>98.8%</b>
1/1+1/2	Left Ahead Right	U	N/A	N/A	C	D	1	57:12	45	586	1766:1839	435+199	92.4 : 92.4%
2/2+2/1	Left Ahead	U	N/A	N/A	F		1	20	-	510	2007:1966	312+305	82.6 : 82.6%
2/3	Right	O	N/A	N/A	E		1	40	-	163	1809	618	26.4%
3/1+3/2	Ahead Right Left	U	N/A	N/A	G		1	23	-	481	1774:1980	355+138	97.5 : 97.5%
4/2+4/1	Left Ahead	U	N/A	N/A	A		1	19	-	648	2093:1902	349+317	97.2 : 97.5%
4/3	Right	O	N/A	N/A	B		1	40	-	596	1765	603	98.8%
5/1		U	N/A	N/A	-		-	-	-	34	Inf	Inf	0.0%
5/2		U	N/A	N/A	-		-	-	-	300	Inf	Inf	0.0%
6/1		U	N/A	N/A	-		-	-	-	459	Inf	Inf	0.0%
6/2		U	N/A	N/A	-		-	-	-	555	Inf	Inf	0.0%
7/1		U	N/A	N/A	-		-	-	-	691	Inf	Inf	0.0%
8/1		U	N/A	N/A	-		-	-	-	551	Inf	Inf	0.0%
8/2		U	N/A	N/A	-		-	-	-	394	Inf	Inf	0.0%

Full Input Data And Results

Item	Arriving (pcu)	Leaving (pcu)	Turners In Gaps (pcu)	Turners When Unopposed (pcu)	Turners In Intergreen (pcu)	Uniform Delay (pcuHr)	Rand + Oversat Delay (pcuHr)	Storage Area Uniform Delay (pcuHr)	Total Delay (pcuHr)	Av. Delay Per PCU (s/pcu)	Max. Back of Uniform Queue (pcu)	Rand + Oversat Queue (pcu)	Mean Max Queue (pcu)
<b>Network</b>	-	-	0	719	40	34.5	35.4	0.0	69.9	-	-	-	-
<b>Unnamed Junction</b>	-	-	0	719	40	34.5	35.4	0.0	69.9	-	-	-	-
1/1+1/2	586	586	-	-	-	5.0	5.0	-	10.0	61.6	8.9	5.0	13.9
2/2+2/1	510	510	-	-	-	6.6	2.3	-	8.9	63.0	8.1	2.3	10.4
2/3	163	163	0	160	3	1.3	0.2	0.0	1.5	32.5	3.9	0.2	4.1
3/1+3/2	481	481	-	-	-	6.1	8.3	-	14.5	108.2	11.4	8.3	19.8
4/2+4/1	648	648	-	-	-	9.0	9.0	-	18.0	99.9	11.2	9.0	20.2
4/3	596	596	0	559	37	6.5	10.6	0.0	17.1	103.1	19.7	10.6	30.3
5/1	34	34	-	-	-	0.0	0.0	-	0.0	0.0	0.0	0.0	0.0
5/2	300	300	-	-	-	0.0	0.0	-	0.0	0.0	0.0	0.0	0.0
6/1	459	459	-	-	-	0.0	0.0	-	0.0	0.0	0.0	0.0	0.0
6/2	555	555	-	-	-	0.0	0.0	-	0.0	0.0	0.0	0.0	0.0
7/1	691	691	-	-	-	0.0	0.0	-	0.0	0.0	0.0	0.0	0.0
8/1	551	551	-	-	-	0.0	0.0	-	0.0	0.0	0.0	0.0	0.0
8/2	394	394	-	-	-	0.0	0.0	-	0.0	0.0	0.0	0.0	0.0
C1			PRC for Signalled Lanes (%):		-9.8	Total Delay for Signalled Lanes (pcuHr):		69.94	Cycle Time (s): 120				
			PRC Over All Lanes (%):		-9.8	Total Delay Over All Lanes(pcuHr):		69.94					



Full Input Data And Results

Scenario 2: 'Option 2 PM Demand' (FG4: 'Option 2 PM Demand', Plan 1: 'Network Control Plan 1')

Stage Sequence Diagram

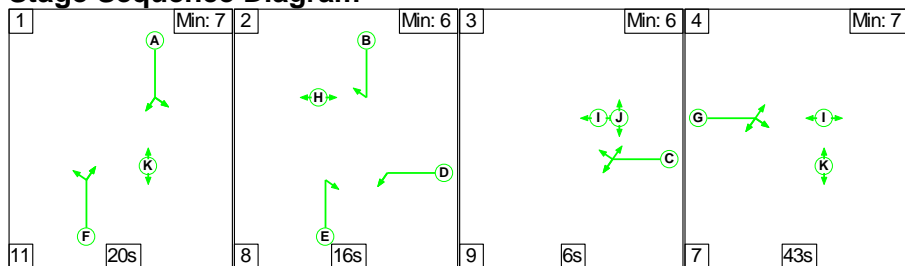

Stage Timings

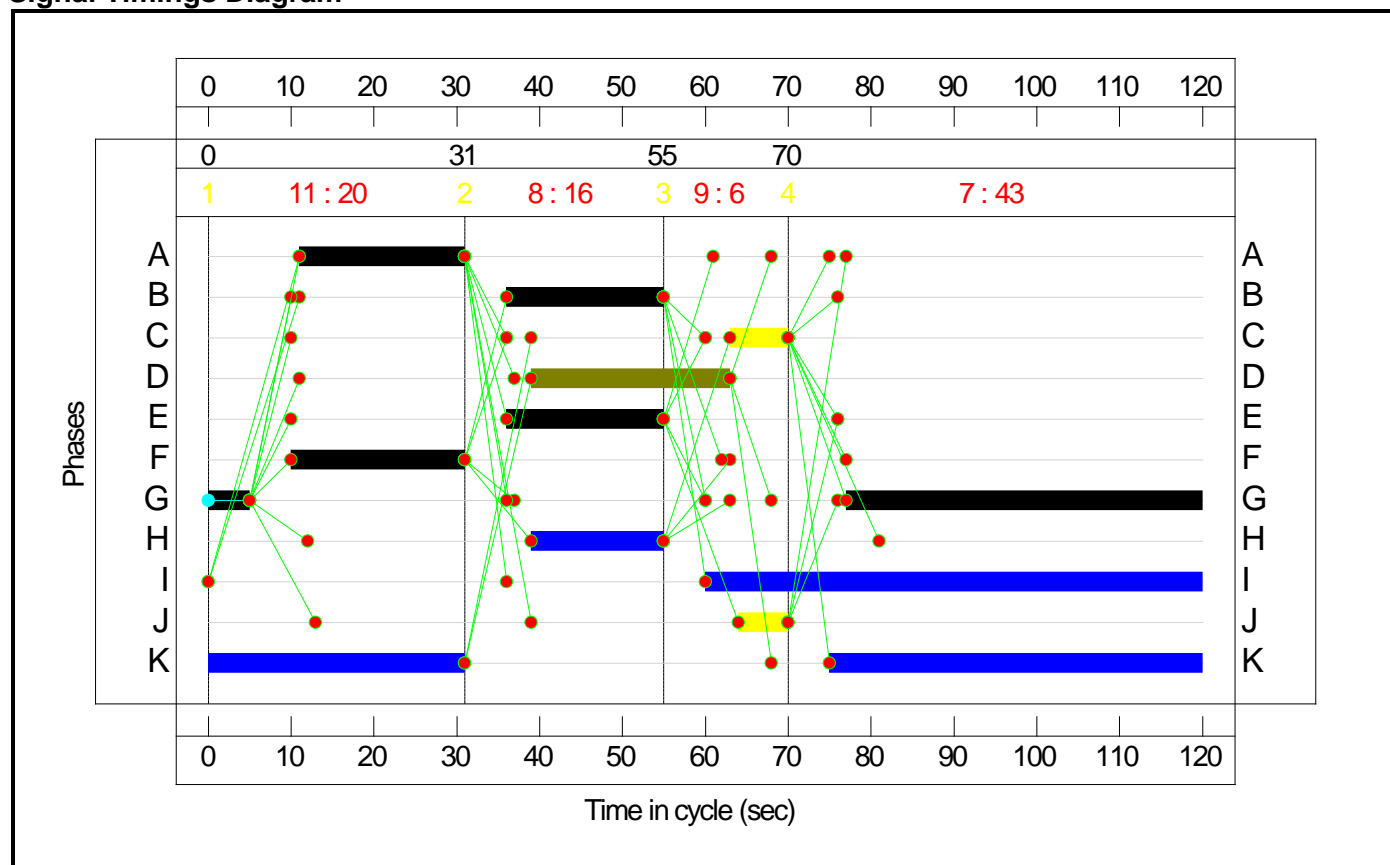

Stage	1	2	3	4
Duration	20	16	6	43
Change Point	0	31	55	70

Signal Timings Diagram

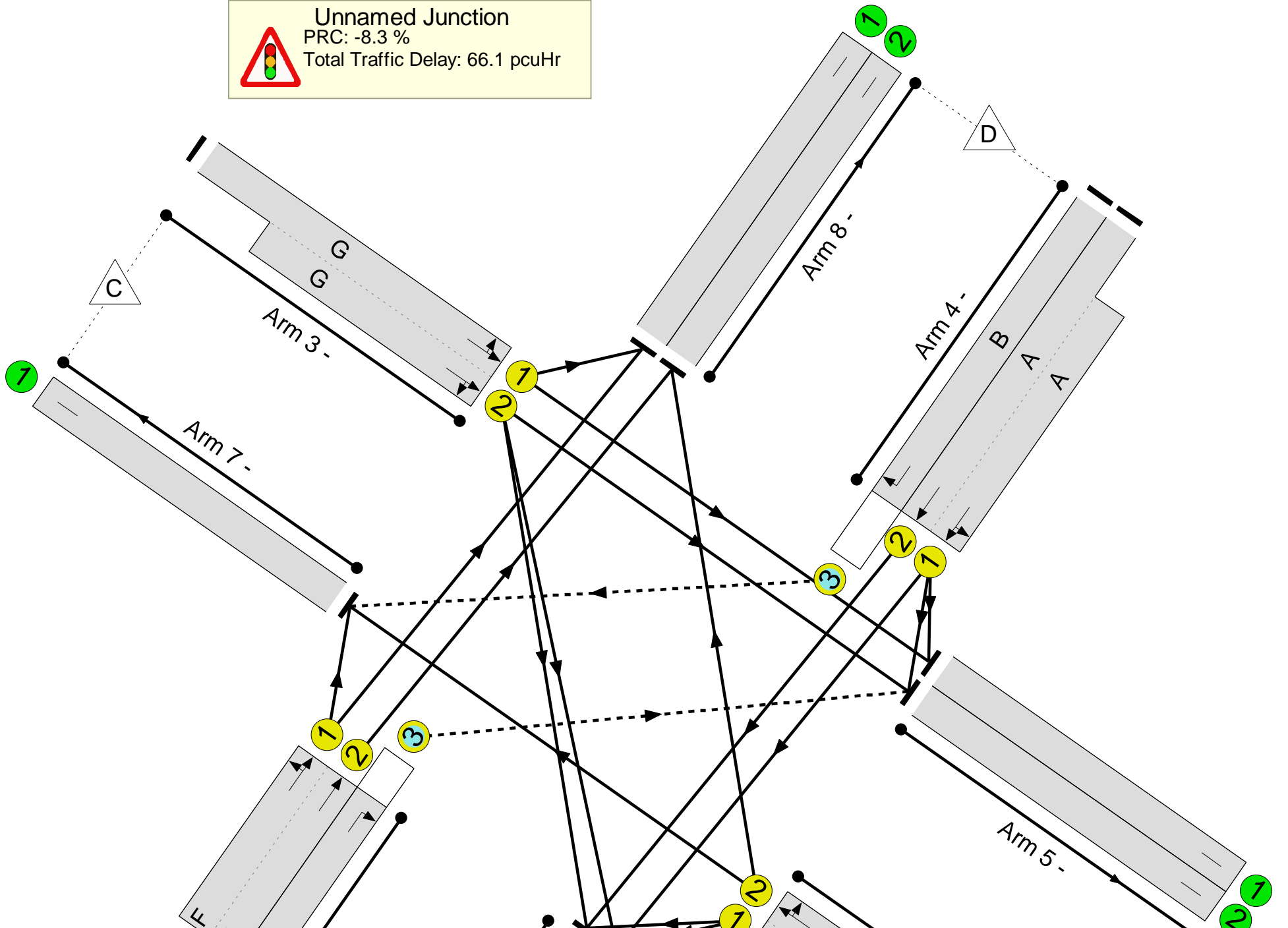

Full Input Data And Results  
**Network Layout Diagram**

Unnamed Junction  
PRC: -8.3 %  
Total Traffic Delay: 66.1 pcuHr



Full Input Data And Results

**Network Results**

Item	Lane Description	Lane Type	Controller Stream	Position In Filtered Route	Full Phase	Arrow Phase	Num Greens	Total Green (s)	Arrow Green (s)	Demand Flow (pcu)	Sat Flow (pcu/Hr)	Capacity (pcu)	Deg Sat (%)
<b>Network</b>	-	-	<b>N/A</b>	-	-		-	-	-	-	-	-	<b>97.4%</b>
<b>Unnamed Junction</b>	-	-	<b>N/A</b>	-	-		-	-	-	-	-	-	<b>97.4%</b>
1/1+1/2	Left Ahead Right	U	N/A	N/A	C	D	1	31:7	24	488	1766:1820	444+107	88.5 : 88.5%
2/2+2/1	Left Ahead	U	N/A	N/A	F		1	21	-	543	2007:1969	319+314	85.8 : 85.8%
2/3	Right	O	N/A	N/A	E		1	19	-	244	1809	302	80.9%
3/1+3/2	Ahead Right Left	U	N/A	N/A	G		1	48	-	872	1774:1953	622+273	97.4 : 97.4%
4/2+4/1	Left Ahead	U	N/A	N/A	A		1	20	-	655	2093:1903	366+333	93.6 : 93.7%
4/3	Right	O	N/A	N/A	B		1	19	-	278	1765	294	94.5%
5/1		U	N/A	N/A	-		-	-	-	34	Inf	Inf	0.0%
5/2		U	N/A	N/A	-		-	-	-	435	Inf	Inf	0.0%
6/1		U	N/A	N/A	-		-	-	-	496	Inf	Inf	0.0%
6/2		U	N/A	N/A	-		-	-	-	593	Inf	Inf	0.0%
7/1		U	N/A	N/A	-		-	-	-	337	Inf	Inf	0.0%
8/1		U	N/A	N/A	-		-	-	-	828	Inf	Inf	0.0%
8/2		U	N/A	N/A	-		-	-	-	357	Inf	Inf	0.0%

Full Input Data And Results

Item	Arriving (pcu)	Leaving (pcu)	Turners In Gaps (pcu)	Turners When Unopposed (pcu)	Turners In Intergreen (pcu)	Uniform Delay (pcuHr)	Rand + Oversat Delay (pcuHr)	Storage Area Uniform Delay (pcuHr)	Total Delay (pcuHr)	Av. Delay Per PCU (s/pcu)	Max. Back of Uniform Queue (pcu)	Rand + Oversat Queue (pcu)	Mean Max Queue (pcu)
<b>Network</b>	-	-	0	490	32	36.6	29.5	0.0	66.1	-	-	-	-
<b>Unnamed Junction</b>	-	-	0	490	32	36.6	29.5	0.0	66.1	-	-	-	-
1/1+1/2	488	488	-	-	-	6.0	3.5	-	9.5	69.8	13.4	3.5	16.8
2/2+2/1	543	543	-	-	-	7.0	2.8	-	9.8	65.2	8.6	2.8	11.4
2/3	244	244	0	240	4	3.3	2.0	0.0	5.2	77.5	7.8	2.0	9.8
3/1+3/2	872	872	-	-	-	7.6	10.1	-	17.8	73.3	23.4	10.1	33.5
4/2+4/1	655	655	-	-	-	8.9	5.8	-	14.7	81.0	11.2	5.8	17.1
4/3	278	278	0	250	28	3.8	5.2	0.0	9.0	117.1	9.1	5.2	14.3
5/1	34	34	-	-	-	0.0	0.0	-	0.0	0.0	0.0	0.0	0.0
5/2	435	435	-	-	-	0.0	0.0	-	0.0	0.0	0.0	0.0	0.0
6/1	496	496	-	-	-	0.0	0.0	-	0.0	0.0	0.0	0.0	0.0
6/2	593	593	-	-	-	0.0	0.0	-	0.0	0.0	0.0	0.0	0.0
7/1	337	337	-	-	-	0.0	0.0	-	0.0	0.0	0.0	0.0	0.0
8/1	828	828	-	-	-	0.0	0.0	-	0.0	0.0	0.0	0.0	0.0
8/2	357	357	-	-	-	0.0	0.0	-	0.0	0.0	0.0	0.0	0.0
C1			PRC for Signalled Lanes (%):		-8.3	Total Delay for Signalled Lanes (pcuHr):		66.09	Cycle Time (s): 120				
			PRC Over All Lanes (%):		-8.3	Total Delay Over All Lanes(pcuHr):		66.09					

**Appendix D**  
**A21 East Dumbbell Roundabout Existing Layout Modelling Results**

Junctions 10
ARCADY 10 - Roundabout Module
Version: 10.1.1.1905 © Copyright TRL Software Limited, 2023
For sales and distribution information, program advice and maintenance, contact TRL Software: +44 (0)1344 379777 software@trl.co.uk trlsoftware.com
The users of this computer program for the solution of an engineering problem are in no way relieved of their responsibility for the correctness of the solution

Filename: Pembury Road\_A21 East Rbt (Existing Layout).j10

Path: J:\332611481 - GH - Tunbridge Wells Local Plan\BRIEF 100 - Pembury Road\MODELLING\TRANSPORT\03. JUNCTIONS 10

Report generation date: 14/05/2024 11:02:15

- »Option 1 Demand, AM
- »Option 1 Demand, PM
- »Option 2 Demand, AM
- »Option 2 Demand, PM

**Summary of junction performance**

	AM						PM					
	Set ID	Q (PCU)	Delay (s)	RFC	LOS	Junction Delay (s)	Set ID	Q (PCU)	Delay (s)	RFC	LOS	Junction Delay (s)
Option 1 Demand												
1 - Pembury Rd East	D1	1.2	4.00	0.55	A	3.38	D2	1.4	4.36	0.58	A	4.54
2 - Tesco Access		0.3	8.33	0.21	A			1.1	12.51	0.53	B	
3 - Pembury Rd West		0.7	2.38	0.40	A			1.3	3.32	0.56	A	
4 - A21		0.5	2.95	0.34	A			0.5	3.30	0.33	A	
Option 2 Demand												
1 - Pembury Rd East	D3	0.1	2.00	0.07	A	3.01	D4	1.5	4.68	0.61	A	4.97
2 - Tesco Access		0.1	3.56	0.11	A			1.3	14.20	0.56	B	
3 - Pembury Rd West		1.0	2.87	0.50	A			1.6	3.77	0.62	A	
4 - A21		0.6	3.39	0.37	A			0.5	3.53	0.35	A	

There are warnings associated with one or more model runs - see the 'Data Errors and Warnings' tables for each Analysis or Demand Set.

Values shown are the highest values encountered over all time segments. Delay is the maximum value of Av. delay per arriving vehicle. Junction LOS and Junction Delay are demand-weighted Av.s.

**File summary**

**File Description**

Title	
Location	
Site number	
Date	25/04/2024
Version	
Status	(new file)
Identifier	
Client	
Jobnumber	
Enumerator	CORP\dansmith
Description	

### Units

Distance units	Speed units	Traffic units input	Traffic units results	Flow units	Av. delay units	Total delay units	Rate of delay units
m	kph	PCU	PCU	perHour	s	-Min	perMin

### Analysis Options

Vehicle length (m)	Calculate Q Percentiles	Calculate detailed queueing delay	Show lane queues in feet / metres	Show all PICADY stream intercepts	Calculate residual capacity	RFC Threshold	Av. Delay threshold (s)	Q threshold (PCU)	Use simulation for HCM roundabouts	Use iterations for HCM roundabouts
5.75						0.85	36.00	20.00		

### Demand Set Summary

ID	Scenario name	Time Period name	Traffic profile type	Start time (HH:mm)	Finish time (HH:mm)	Time segment length (min)	Run automatically
D1	Option 1 Demand	AM	ONE HOUR	07:15	08:45	15	✓
D2	Option 1 Demand	PM	ONE HOUR	16:45	18:15	15	✓
D3	Option 2 Demand	AM	ONE HOUR	07:15	08:45	15	✓
D4	Option 2 Demand	PM	ONE HOUR	16:45	18:15	15	✓

### Analysis Set Details

ID	Include in report	Network flow scaling factor (%)	Network capacity scaling factor (%)
A1	✓	100.000	100.000



# Option 1 Demand, AM

## Data Errors and Warnings

Severity	Area	Item	Description
Warning	Vehicle Mix		HV% is zero for all movements / time segments. Vehicle Mix matrix should be completed whether working in PCUs or Vehs. If HV% at the junction is genuinely zero, please ignore this warning.

## Junction Network

### Junctions

Junction	Name	Junction type	Use circulating lanes	Arm order	Junction Delay (s)	Junction LOS
1	untitled	Standard Roundabout		1, 2, 3, 4	3.38	A

### Junction Network

Driving side	Lighting	Network delay (s)	Network LOS
Left	Normal/unknown	3.38	A

## Arms

### Arms

Arm	Name	Description	No give-way line
1	Pembury Rd East		
2	Tesco Access		
3	Pembury Rd West		
4	A21		

### Roundabout Geometry

Arm	V (m)	E (m)	I' (m)	R (m)	D (m)	PHI (deg)	Entry only	Exit only
1 - Pembury Rd East	7.95	10.81	4.5	18.2	41.0	46.7		
2 - Tesco Access	4.57	6.33	3.5	16.2	41.0	40.1		
3 - Pembury Rd West	7.62	10.25	3.5	17.5	50.0	26.1		
4 - A21	5.53	9.84	13.1	21.4	41.0	22.6		

### Slope / Intercept / Capacity

#### Roundabout Slope and Intercept used in model

Arm	Final slope	Final intercept (PCU/hr)
1 - Pembury Rd East	0.785	2527
2 - Tesco Access	0.589	1517
3 - Pembury Rd West	0.773	2561
4 - A21	0.783	2379

The slope and intercept shown above include any corrections and adjustments.

## Traffic Demand

### Demand Set Details

ID	Scenario name	Time Period name	Traffic profile type	Start time (HH:mm)	Finish time (HH:mm)	Time segment length (min)	Run automatically
D1	Option 1 Demand	AM	ONE HOUR	07:15	08:45	15	✓

### Demand overview (Traffic)

Arm	Linked arm	Profile type	Use O-D data	Av. Demand (PCU/hr)	Scaling Factor (%)
1 - Pembury Rd East		ONE HOUR	✓	1011	100.000
2 - Tesco Access		ONE HOUR	✓	107	100.000
3 - Pembury Rd West		ONE HOUR	✓	925	100.000
4 - A21		ONE HOUR	✓	560	100.000

## Origin-Destination Data

### Demand (PCU/hr)

From	To				
	1 - Pembury Rd East	2 - Tesco Access	3 - Pembury Rd West	4 - A21	
1 - Pembury Rd East	2	56	950	3	
2 - Tesco Access	25	0	76	6	
3 - Pembury Rd West	565	36	0	324	
4 - A21	0	24	536	0	

## Vehicle Mix

HV data entry mode	PCU Factor for a HV (PCU)
HV Percentages	2.00

### Heavy Vehicle %

From	To				
	1 - Pembury Rd East	2 - Tesco Access	3 - Pembury Rd West	4 - A21	
1 - Pembury Rd East	0	0	0	0	
2 - Tesco Access	0	0	0	0	
3 - Pembury Rd West	0	0	0	0	
4 - A21	0	0	0	0	

## Results

### Results Summary for whole modelled period

Arm	Max RFC	Max Delay (s)	Max Q (PCU)	Max LOS	Av. Demand (PCU/hr)	Total Junction Arrivals (PCU)
1 - Pembury Rd East	0.55	4.00	1.2	A	928	1392
2 - Tesco Access	0.21	8.33	0.3	A	98	147
3 - Pembury Rd West	0.40	2.38	0.7	A	849	1273
4 - A21	0.34	2.95	0.5	A	514	771

# Option 1 Demand, PM

## Data Errors and Warnings

Severity	Area	Item	Description
Warning	Vehicle Mix		HV% is zero for all movements / time segments. Vehicle Mix matrix should be completed whether working in PCUs or Vehs. If HV% at the junction is genuinely zero, please ignore this warning.

## Junction Network

### Junctions

Junction	Name	Junction type	Use circulating lanes	Arm order	Junction Delay (s)	Junction LOS
1	untitled	Standard Roundabout		1, 2, 3, 4	4.54	A

### Junction Network

Driving side	Lighting	Network delay (s)	Network LOS
Left	Normal/unknown	4.54	A

## Traffic Demand

### Demand Set Details

ID	Scenario name	Time Period name	Traffic profile type	Start time (HH:mm)	Finish time (HH:mm)	Time segment length (min)	Run automatically
D2	Option 1 Demand	PM	ONE HOUR	16:45	18:15	15	✓

### Demand overview (Traffic)

Arm	Linked arm	Profile type	Use O-D data	Av. Demand (PCU/hr)	Scaling Factor (%)
1 - Pembury Rd East		ONE HOUR	✓	1043	100.000
2 - Tesco Access		ONE HOUR	✓	293	100.000
3 - Pembury Rd West		ONE HOUR	✓	1271	100.000
4 - A21		ONE HOUR	✓	491	100.000

## Origin-Destination Data

### Demand (PCU/hr)

		To			
		1 - Pembury Rd East	2 - Tesco Access	3 - Pembury Rd West	4 - A21
From	1 - Pembury Rd East	0	125	917	1
	2 - Tesco Access	62	0	203	28
	3 - Pembury Rd West	655	150	0	466
	4 - A21	0	11	480	0

## Vehicle Mix

HV data entry mode	PCU Factor for a HV (PCU)
HV Percentages	2.00

**Heavy Vehicle %**

		To			
		1 - Pembury Rd East	2 - Tesco Access	3 - Pembury Rd West	4 - A21
From	1 - Pembury Rd East	0	0	0	0
	2 - Tesco Access	0	0	0	0
	3 - Pembury Rd West	0	0	0	0
	4 - A21	0	0	0	0

## Results

**Results Summary for whole modelled period**

Arm	Max RFC	Max Delay (s)	Max Q (PCU)	Max LOS	Av. Demand (PCU/hr)	Total Junction Arrivals (PCU)
1 - Pembury Rd East	0.58	4.36	1.4	A	957	1436
2 - Tesco Access	0.53	12.51	1.1	B	269	403
3 - Pembury Rd West	0.56	3.32	1.3	A	1166	1749
4 - A21	0.33	3.30	0.5	A	451	676

# Option 2 Demand, AM

## Data Errors and Warnings

Severity	Area	Item	Description
Warning	Vehicle Mix		HV% is zero for all movements / time segments. Vehicle Mix matrix should be completed whether working in PCUs or Vehs. If HV% at the junction is genuinely zero, please ignore this warning.

## Junction Network

### Junctions

Junction	Name	Junction type	Use circulating lanes	Arm order	Junction Delay (s)	Junction LOS
1	untitled	Standard Roundabout		1, 2, 3, 4	3.01	A

### Junction Network

Driving side	Lighting	Network delay (s)	Network LOS
Left	Normal/unknown	3.01	A

## Traffic Demand

### Demand Set Details

ID	Scenario name	Time Period name	Traffic profile type	Start time (HH:mm)	Finish time (HH:mm)	Time segment length (min)	Run automatically
D3	Option 2 Demand	AM	ONE HOUR	07:15	08:45	15	✓

### Demand overview (Traffic)

Arm	Linked arm	Profile type	Use O-D data	Av. Demand (PCU/hr)	Scaling Factor (%)
1 - Pembury Rd East		ONE HOUR	✓	114	100.000
2 - Tesco Access		ONE HOUR	✓	108	100.000
3 - Pembury Rd West		ONE HOUR	✓	1151	100.000
4 - A21		ONE HOUR	✓	562	100.000

## Origin-Destination Data

### Demand (PCU/hr)

		To			
		1 - Pembury Rd East	2 - Tesco Access	3 - Pembury Rd West	4 - A21
From	1 - Pembury Rd East	10	54	44	6
	2 - Tesco Access	27	0	75	6
	3 - Pembury Rd West	636	138	0	377
	4 - A21	0	24	538	0

## Vehicle Mix

HV data entry mode	PCU Factor for a HV (PCU)
HV Percentages	2.00

**Heavy Vehicle %**

		To			
		1 - Pembury Rd East	2 - Tesco Access	3 - Pembury Rd West	4 - A21
From	1 - Pembury Rd East	0	0	0	0
	2 - Tesco Access	0	0	0	0
	3 - Pembury Rd West	0	0	0	0
	4 - A21	0	0	0	0

## Results

**Results Summary for whole modelled period**

Arm	Max RFC	Max Delay (s)	Max Q (PCU)	Max LOS	Av. Demand (PCU/hr)	Total Junction Arrivals (PCU)
1 - Pembury Rd East	0.07	2.00	0.1	A	105	157
2 - Tesco Access	0.11	3.56	0.1	A	99	149
3 - Pembury Rd West	0.50	2.87	1.0	A	1056	1584
4 - A21	0.37	3.39	0.6	A	516	774

# Option 2 Demand, PM

## Data Errors and Warnings

Severity	Area	Item	Description
Warning	Vehicle Mix		HV% is zero for all movements / time segments. Vehicle Mix matrix should be completed whether working in PCUs or Vehs. If HV% at the junction is genuinely zero, please ignore this warning.

## Junction Network

### Junctions

Junction	Name	Junction type	Use circulating lanes	Arm order	Junction Delay (s)	Junction LOS
1	untitled	Standard Roundabout		1, 2, 3, 4	4.97	A

### Junction Network

Driving side	Lighting	Network delay (s)	Network LOS
Left	Normal/unknown	4.97	A

## Traffic Demand

### Demand Set Details

ID	Scenario name	Time Period name	Traffic profile type	Start time (HH:mm)	Finish time (HH:mm)	Time segment length (min)	Run automatically
D4	Option 2 Demand	PM	ONE HOUR	16:45	18:15	15	✓

### Demand overview (Traffic)

Arm	Linked arm	Profile type	Use O-D data	Av. Demand (PCU/hr)	Scaling Factor (%)
1 - Pembury Rd East		ONE HOUR	✓	1088	100.000
2 - Tesco Access		ONE HOUR	✓	293	100.000
3 - Pembury Rd West		ONE HOUR	✓	1386	100.000
4 - A21		ONE HOUR	✓	499	100.000

## Origin-Destination Data

### Demand (PCU/hr)

		To			
		1 - Pembury Rd East	2 - Tesco Access	3 - Pembury Rd West	4 - A21
From	1 - Pembury Rd East	0	125	957	6
	2 - Tesco Access	62	0	203	28
	3 - Pembury Rd West	726	150	0	510
	4 - A21	0	11	488	0

## Vehicle Mix

HV data entry mode	PCU Factor for a HV (PCU)
HV Percentages	2.00

**Heavy Vehicle %**

		To			
		1 - Pembury Rd East	2 - Tesco Access	3 - Pembury Rd West	4 - A21
From	1 - Pembury Rd East	0	0	0	0
	2 - Tesco Access	0	0	0	0
	3 - Pembury Rd West	0	0	0	0
	4 - A21	0	0	0	0

## Results

**Results Summary for whole modelled period**

Arm	Max RFC	Max Delay (s)	Max Q (PCU)	Max LOS	Av. Demand (PCU/hr)	Total Junction Arrivals (PCU)
1 - Pembury Rd East	0.61	4.68	1.5	A	998	1498
2 - Tesco Access	0.56	14.20	1.3	B	269	403
3 - Pembury Rd West	0.62	3.77	1.6	A	1272	1908
4 - A21	0.35	3.53	0.5	A	458	687



**Appendix E**  
**A21 West Dumbbell Roundabout Existing Layout Modelling Results**

Junctions 10
ARCADY 10 - Roundabout Module
Version: 10.1.1.1905 © Copyright TRL Software Limited, 2023
For sales and distribution information, program advice and maintenance, contact TRL Software: +44 (0)1344 379777 software@trl.co.uk trlsoftware.com
The users of this computer program for the solution of an engineering problem are in no way relieved of their responsibility for the correctness of the solution

**Filename:** Pembury Road\_A21 West Rbt (Existing Layout).j10  
**Path:** J:\332611481 - GH - Tunbridge Wells Local Plan\BRIEF 100 - Pembury Road\MODELLING\TRANSPORT\03. JUNCTIONS 10  
**Report generation date:** 14/05/2024 11:02:33

- »Option 1 Demand, AM
- »Option 1 Demand, PM
- »Option 2 Demand, AM
- »Option 2 Demand, PM

**Summary of junction performance**

	AM						PM					
	Set ID	Q (PCU)	Delay (s)	RFC	LOS	Junction Delay (s)	Set ID	Q (PCU)	Delay (s)	RFC	LOS	Junction Delay (s)
<b>Option 1 Demand</b>												
1 - Pembury Rd East	D1	10.9	24.23	0.93	C	66.44	D2	9.1	19.69	0.91	C	15.51
2 - Pembury Rd West		80.8	121.22	1.07	F			7.7	15.47	0.89	C	
3 - A21		0.6	3.02	0.37	A			0.6	3.54	0.37	A	
<b>Option 2 Demand</b>												
1 - Pembury Rd East	D3	11.3	25.22	0.93	D	123.87	D4	12.9	27.34	0.94	D	23.43
2 - Pembury Rd West		153.7	235.15	1.14	F			13.4	25.90	0.94	D	
3 - A21		0.6	3.19	0.39	A			0.7	3.95	0.40	A	

There are warnings associated with one or more model runs - see the 'Data Errors and Warnings' tables for each Analysis or Demand Set.

Values shown are the highest values encountered over all time segments. Delay is the maximum value of Av. delay per arriving vehicle. Junction LOS and Junction Delay are demand-weighted Av.s.

**File summary**

**File Description**

<b>Title</b>	
<b>Location</b>	
<b>Site number</b>	
<b>Date</b>	25/04/2024
<b>Version</b>	
<b>Status</b>	(new file)
<b>Identifier</b>	
<b>Client</b>	
<b>Jobnumber</b>	
<b>Enumerator</b>	CORP\dansmith
<b>Description</b>	

### Units

Distance units	Speed units	Traffic units input	Traffic units results	Flow units	Av. delay units	Total delay units	Rate of delay units
m	kph	PCU	PCU	perHour	s	-Min	perMin

### Analysis Options

Vehicle length (m)	Calculate Q Percentiles	Calculate detailed queueing delay	Show lane queues in feet / metres	Show all PICADY stream intercepts	Calculate residual capacity	RFC Threshold	Av. Delay threshold (s)	Q threshold (PCU)	Use simulation for HCM roundabouts	Use iterations for HCM roundabouts
5.75						0.85	36.00	20.00		

### Demand Set Summary

ID	Scenario name	Time Period name	Traffic profile type	Start time (HH:mm)	Finish time (HH:mm)	Time segment length (min)	Run automatically
D1	Option 1 Demand	AM	ONE HOUR	07:15	08:45	15	✓
D2	Option 1 Demand	PM	ONE HOUR	16:45	18:15	15	✓
D3	Option 2 Demand	AM	ONE HOUR	07:15	08:45	15	✓
D4	Option 2 Demand	PM	ONE HOUR	16:45	18:15	15	✓

### Analysis Set Details

ID	Include in report	Network flow scaling factor (%)	Network capacity scaling factor (%)
A1	✓	100.000	100.000

# Option 1 Demand, AM

## Data Errors and Warnings

Severity	Area	Item	Description
Warning	Vehicle Mix		HV% is zero for all movements / time segments. Vehicle Mix matrix should be completed whether working in PCUs or Vehs. If HV% at the junction is genuinely zero, please ignore this warning.

## Junction Network

### Junctions

Junction	Name	Junction type	Use circulating lanes	Arm order	Junction Delay (s)	Junction LOS
1	untitled	Standard Roundabout		1, 2, 3	66.44	F

### Junction Network

Driving side	Lighting	Network delay (s)	Network LOS
Left	Normal/unknown	66.44	F

## Arms

### Arms

Arm	Name	Description	No give-way line
1	Pembury Rd East		
2	Pembury Rd West		
3	A21		

### Roundabout Geometry

Arm	V (m)	E (m)	I' (m)	R (m)	D (m)	PHI (deg)	Entry only	Exit only
1 - Pembury Rd East	6.97	8.59	19.7	26.6	41.7	49.8		
2 - Pembury Rd West	4.80	9.97	13.6	56.3	41.7	22.6		
3 - A21	10.28	10.33	0.1	11.6	41.7	57.6		

### Slope / Intercept / Capacity

#### Roundabout Slope and Intercept used in model

Arm	Final slope	Final intercept (PCU/hr)
1 - Pembury Rd East	0.751	2360
2 - Pembury Rd West	0.770	2283
3 - A21	0.799	2710

The slope and intercept shown above include any corrections and adjustments.

## Traffic Demand

### Demand Set Details

ID	Scenario name	Time Period name	Traffic profile type	Start time (HH:mm)	Finish time (HH:mm)	Time segment length (min)	Run automatically
D1	Option 1 Demand	AM	ONE HOUR	07:15	08:45	15	✓

### Demand overview (Traffic)

Arm	Linked arm	Profile type	Use O-D data	Av. Demand (PCU/hr)	Scaling Factor (%)
1 - Pembury Rd East		ONE HOUR	✓	1562	100.000
2 - Pembury Rd West		ONE HOUR	✓	1932	100.000
3 - A21		ONE HOUR	✓	629	100.000

## Origin-Destination Data

### Demand (PCU/hr)

		To		
		1 - Pembury Rd East	2 - Pembury Rd West	3 - A21
From	1 - Pembury Rd East	0	1218	344
	2 - Pembury Rd West	1007	0	925
	3 - A21	18	611	0

## Vehicle Mix

HV data entry mode	PCU Factor for a HV (PCU)
HV Percentages	2.00

### Heavy Vehicle %

		To		
		1 - Pembury Rd East	2 - Pembury Rd West	3 - A21
From	1 - Pembury Rd East	0	0	0
	2 - Pembury Rd West	0	0	0
	3 - A21	0	0	0

## Results

### Results Summary for whole modelled period

Arm	Max RFC	Max Delay (s)	Max Q (PCU)	Max LOS	Av. Demand (PCU/hr)	Total Junction Arrivals (PCU)
1 - Pembury Rd East	0.93	24.23	10.9	C	1433	2150
2 - Pembury Rd West	1.07	121.22	80.8	F	1773	2659
3 - A21	0.37	3.02	0.6	A	577	866

# Option 1 Demand, PM

## Data Errors and Warnings

Severity	Area	Item	Description
Warning	Vehicle Mix		HV% is zero for all movements / time segments. Vehicle Mix matrix should be completed whether working in PCUs or Vehs. If HV% at the junction is genuinely zero, please ignore this warning.

## Junction Network

### Junctions

Junction	Name	Junction type	Use circulating lanes	Arm order	Junction Delay (s)	Junction LOS
1	untitled	Standard Roundabout		1, 2, 3	15.51	C

### Junction Network

Driving side	Lighting	Network delay (s)	Network LOS
Left	Normal/unknown	15.51	C

## Traffic Demand

### Demand Set Details

ID	Scenario name	Time Period name	Traffic profile type	Start time (HH:mm)	Finish time (HH:mm)	Time segment length (min)	Run automatically
D2	Option 1 Demand	PM	ONE HOUR	16:45	18:15	15	✓

### Demand overview (Traffic)

Arm	Linked arm	Profile type	Use O-D data	Av. Demand (PCU/hr)	Scaling Factor (%)
1 - Pembury Rd East		ONE HOUR	✓	1599	100.000
2 - Pembury Rd West		ONE HOUR	✓	1714	100.000
3 - A21		ONE HOUR	✓	551	100.000

## Origin-Destination Data

### Demand (PCU/hr)

		To		
		1 - Pembury Rd East	2 - Pembury Rd West	3 - A21
From	1 - Pembury Rd East	0	1399	200
	2 - Pembury Rd West	1236	0	478
	3 - A21	36	515	0

## Vehicle Mix

HV data entry mode	PCU Factor for a HV (PCU)
HV Percentages	2.00

### Heavy Vehicle %

		To		
		1 - Pembury Rd East	2 - Pembury Rd West	3 - A21
From	1 - Pembury Rd East	0	0	0
	2 - Pembury Rd West	0	0	0
	3 - A21	0	0	0

## Results

### Results Summary for whole modelled period

Arm	Max RFC	Max Delay (s)	Max Q (PCU)	Max LOS	Av. Demand (PCU/hr)	Total Junction Arrivals (PCU)
1 - Pembury Rd East	0.91	19.69	9.1	C	1467	2201
2 - Pembury Rd West	0.89	15.47	7.7	C	1573	2359
3 - A21	0.37	3.54	0.6	A	506	758

# Option 2 Demand, AM

## Data Errors and Warnings

Severity	Area	Item	Description
Warning	Vehicle Mix		HV% is zero for all movements / time segments. Vehicle Mix matrix should be completed whether working in PCUs or Vehs. If HV% at the junction is genuinely zero, please ignore this warning.

## Junction Network

### Junctions

Junction	Name	Junction type	Use circulating lanes	Arm order	Junction Delay (s)	Junction LOS
1	untitled	Standard Roundabout		1, 2, 3	123.87	F

### Junction Network

Driving side	Lighting	Network delay (s)	Network LOS
Left	Normal/unknown	123.87	F

## Traffic Demand

### Demand Set Details

ID	Scenario name	Time Period name	Traffic profile type	Start time (HH:mm)	Finish time (HH:mm)	Time segment length (min)	Run automatically
D3	Option 2 Demand	AM	ONE HOUR	07:15	08:45	15	✓

### Demand overview (Traffic)

Arm	Linked arm	Profile type	Use O-D data	Av. Demand (PCU/hr)	Scaling Factor (%)
1 - Pembury Rd East		ONE HOUR	✓	1557	100.000
2 - Pembury Rd West		ONE HOUR	✓	2082	100.000
3 - A21		ONE HOUR	✓	647	100.000

## Origin-Destination Data

### Demand (PCU/hr)

		To		
		1 - Pembury Rd East	2 - Pembury Rd West	3 - A21
From	1 - Pembury Rd East	0	1230	327
	2 - Pembury Rd West	1130	0	952
	3 - A21	21	626	0

## Vehicle Mix

HV data entry mode	PCU Factor for a HV (PCU)
HV Percentages	2.00

### Heavy Vehicle %

		To		
		1 - Pembury Rd East	2 - Pembury Rd West	3 - A21
From	1 - Pembury Rd East	0	0	0
	2 - Pembury Rd West	0	0	0
	3 - A21	0	0	0



## Results

### Results Summary for whole modelled period

Arm	Max RFC	Max Delay (s)	Max Q (PCU)	Max LOS	Av. Demand (PCU/hr)	Total Junction Arrivals (PCU)
1 - Pembury Rd East	0.93	25.22	11.3	D	1429	2143
2 - Pembury Rd West	1.14	235.15	153.7	F	1910	2866
3 - A21	0.39	3.19	0.6	A	594	891

# Option 2 Demand, PM

## Data Errors and Warnings

Severity	Area	Item	Description
Warning	Vehicle Mix		HV% is zero for all movements / time segments. Vehicle Mix matrix should be completed whether working in PCUs or Vehs. If HV% at the junction is genuinely zero, please ignore this warning.

## Junction Network

### Junctions

Junction	Name	Junction type	Use circulating lanes	Arm order	Junction Delay (s)	Junction LOS
1	untitled	Standard Roundabout		1, 2, 3	23.43	C

### Junction Network

Driving side	Lighting	Network delay (s)	Network LOS
Left	Normal/unknown	23.43	C

## Traffic Demand

### Demand Set Details

ID	Scenario name	Time Period name	Traffic profile type	Start time (HH:mm)	Finish time (HH:mm)	Time segment length (min)	Run automatically
D4	Option 2 Demand	PM	ONE HOUR	16:45	18:15	15	✓

### Demand overview (Traffic)

Arm	Linked arm	Profile type	Use O-D data	Av. Demand (PCU/hr)	Scaling Factor (%)
1 - Pembury Rd East		ONE HOUR	✓	1648	100.000
2 - Pembury Rd West		ONE HOUR	✓	1804	100.000
3 - A21		ONE HOUR	✓	560	100.000

## Origin-Destination Data

### Demand (PCU/hr)

		To		
		1 - Pembury Rd East	2 - Pembury Rd West	3 - A21
From	1 - Pembury Rd East	0	1438	210
	2 - Pembury Rd West	1349	0	455
	3 - A21	37	523	0

## Vehicle Mix

HV data entry mode	PCU Factor for a HV (PCU)
HV Percentages	2.00

### Heavy Vehicle %

		To		
		1 - Pembury Rd East	2 - Pembury Rd West	3 - A21
From	1 - Pembury Rd East	0	0	0
	2 - Pembury Rd West	0	0	0
	3 - A21	0	0	0

## Results

### Results Summary for whole modelled period

Arm	Max RFC	Max Delay (s)	Max Q (PCU)	Max LOS	Av. Demand (PCU/hr)	Total Junction Arrivals (PCU)
1 - Pembury Rd East	0.94	27.34	12.9	D	1512	2268
2 - Pembury Rd West	0.94	25.90	13.4	D	1655	2483
3 - A21	0.40	3.95	0.7	A	514	771

**Appendix F**  
**A21 West Dumbbell Roundabout Potential Junction Improvements Drawing**

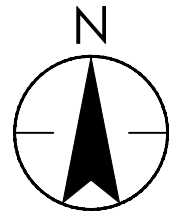

Plotted: 27.06.2024 08:25:42 AM By: Smith, Daniel  
ORIGINAL SHEET - ISOA3  
I:\332611481\gh - tunbridge wells local plan\3-autocad\drawings\100\332611481-str-hgn-h-0004a - pembury road junctions mitigation - a21 west.tbt

ED & Ward Bdy

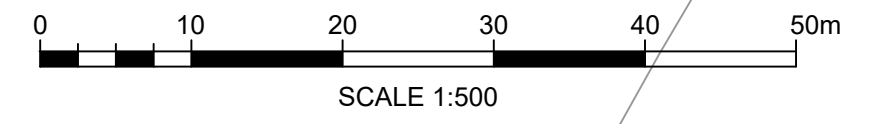

**Stantec**  
Stantec UK Limited  
Unit 10, Connect 38, 1 Dover Place  
Ashford  
TN23 1FB  
Tel: +44 1233 527 250  
www.stantec.com/uk

**S2 FOR INFORMATION**

Client/Project:  
TWBC  
  
TUNBRIDGE WELLS  
LOCAL PLAN  
  
Project No.:  
332611481

Title  
PEMBURY ROAD POTENTIAL  
MITIGATION SCHEME - A21  
WEST ROUNDABOUT  
  
Revision: A Date: 2024.06.05 Drawing No. 0004

**Appendix G**  
**A21 West Dumbbell Roundabout Potential Junction Improvements Modelling**  
**Results**

Junctions 10
ARCADY 10 - Roundabout Module
Version: 10.1.1.1905 © Copyright TRL Software Limited, 2023
For sales and distribution information, program advice and maintenance, contact TRL Software: +44 (0)1344 379777 software@trl.co.uk trlsoftware.com
The users of this computer program for the solution of an engineering problem are in no way relieved of their responsibility for the correctness of the solution

**Filename:** Pembury Road\_A21 West Rbt (Mitigation Layout).j10  
**Path:** J:\332611481 - GH - Tunbridge Wells Local Plan\BRIEF 100 - Pembury Road\MODELLING\TRANSPORT\03. JUNCTIONS 10  
**Report generation date:** 14/05/2024 11:02:49

»Option 2 Demand, AM  
 »Option 2 Demand, PM

**Summary of junction performance**

	AM						PM					
	Set ID	Q (PCU)	Delay (s)	RFC	LOS	Junction Delay (s)	Set ID	Q (PCU)	Delay (s)	RFC	LOS	Junction Delay (s)
Option 2 Demand												
1 - Pembury Rd East	D3	7.2	15.78	0.89	C	13.09	D4	8.0	16.59	0.90	C	9.79
2 - Pembury Rd West		8.5	14.04	0.90	B			2.9	5.39	0.75	A	
3 - A21		0.7	3.58	0.41	A			0.7	3.97	0.40	A	

There are warnings associated with one or more model runs - see the 'Data Errors and Warnings' tables for each Analysis or Demand Set.

Values shown are the highest values encountered over all time segments. Delay is the maximum value of Av. delay per arriving vehicle. Junction LOS and Junction Delay are demand-weighted Av.s.

**File summary**

**File Description**

<b>Title</b>	
<b>Location</b>	
<b>Site number</b>	
<b>Date</b>	25/04/2024
<b>Version</b>	
<b>Status</b>	(new file)
<b>Identifier</b>	
<b>Client</b>	
<b>Jobnumber</b>	
<b>Enumerator</b>	CORP\dansmith
<b>Description</b>	

**Units**

Distance units	Speed units	Traffic units input	Traffic units results	Flow units	Av. delay units	Total delay units	Rate of delay units
m	kph	PCU	PCU	perHour	s	-Min	perMin

### Analysis Options

Vehicle length (m)	Calculate Q Percentiles	Calculate detailed queueing delay	Show lane queues in feet / metres	Show all PICADY stream intercepts	Calculate residual capacity	RFC Threshold	Av. Delay threshold (s)	Q threshold (PCU)	Use simulation for HCM roundabouts	Use iterations for HCM roundabouts
5.75						0.85	36.00	20.00		

### Demand Set Summary

ID	Scenario name	Time Period name	Traffic profile type	Start time (HH:mm)	Finish time (HH:mm)	Time segment length (min)	Run automatically
D1	Option 1 Demand	AM	ONE HOUR	07:15	08:45	15	
D2	Option 1 Demand	PM	ONE HOUR	16:45	18:15	15	
D3	Option 2 Demand	AM	ONE HOUR	07:15	08:45	15	✓
D4	Option 2 Demand	PM	ONE HOUR	16:45	18:15	15	✓

### Analysis Set Details

ID	Include in report	Network flow scaling factor (%)	Network capacity scaling factor (%)
A1	✓	100.000	100.000



# Option 2 Demand, AM

## Data Errors and Warnings

Severity	Area	Item	Description
Warning	Geometry	2 - Pembury Rd West - Roundabout Geometry	Effective flare length is over 30m, which is outside the normal range. Treat capacities with increasing caution.
Warning	Vehicle Mix		HV% is zero for all movements / time segments. Vehicle Mix matrix should be completed whether working in PCUs or Vehs. If HV% at the junction is genuinely zero, please ignore this warning.

## Junction Network

### Junctions

Junction	Name	Junction type	Use circulating lanes	Arm order	Junction Delay (s)	Junction LOS
1	untitled	Standard Roundabout		1, 2, 3	13.09	B

### Junction Network

Driving side	Lighting	Network delay (s)	Network LOS
Left	Normal/unknown	13.09	B

## Arms

### Arms

Arm	Name	Description	No give-way line
1	Pembury Rd East		
2	Pembury Rd West		
3	A21		

### Roundabout Geometry

Arm	V (m)	E (m)	I' (m)	R (m)	D (m)	PHI (deg)	Entry only	Exit only
1 - Pembury Rd East	6.97	9.00	30.0	26.6	41.7	49.8		
2 - Pembury Rd West	4.80	12.00	35.0	56.3	41.7	30.0		
3 - A21	10.28	10.33	0.1	11.6	41.7	57.6		

### Slope / Intercept / Capacity

#### Roundabout Slope and Intercept used in model

Arm	Final slope	Final intercept (PCU/hr)
1 - Pembury Rd East	0.773	2470
2 - Pembury Rd West	0.877	2856
3 - A21	0.799	2710

The slope and intercept shown above include any corrections and adjustments.

## Traffic Demand

### Demand Set Details

ID	Scenario name	Time Period name	Traffic profile type	Start time (HH:mm)	Finish time (HH:mm)	Time segment length (min)	Run automatically
D3	Option 2 Demand	AM	ONE HOUR	07:15	08:45	15	✓

### Demand overview (Traffic)

Arm	Linked arm	Profile type	Use O-D data	Av. Demand (PCU/hr)	Scaling Factor (%)
1 - Pembury Rd East		ONE HOUR	✓	1557	100.000
2 - Pembury Rd West		ONE HOUR	✓	2082	100.000
3 - A21		ONE HOUR	✓	647	100.000

## Origin-Destination Data

### Demand (PCU/hr)

		To		
		1 - Pembury Rd East	2 - Pembury Rd West	3 - A21
From	1 - Pembury Rd East	0	1230	327
	2 - Pembury Rd West	1130	0	952
	3 - A21	21	626	0

## Vehicle Mix

HV data entry mode	PCU Factor for a HV (PCU)
HV Percentages	2.00

### Heavy Vehicle %

		To		
		1 - Pembury Rd East	2 - Pembury Rd West	3 - A21
From	1 - Pembury Rd East	0	0	0
	2 - Pembury Rd West	0	0	0
	3 - A21	0	0	0

## Results

### Results Summary for whole modelled period

Arm	Max RFC	Max Delay (s)	Max Q (PCU)	Max LOS	Av. Demand (PCU/hr)	Total Junction Arrivals (PCU)
1 - Pembury Rd East	0.89	15.78	7.2	C	1429	2143
2 - Pembury Rd West	0.90	14.04	8.5	B	1910	2866
3 - A21	0.41	3.58	0.7	A	594	891

# Option 2 Demand, PM

## Data Errors and Warnings

Severity	Area	Item	Description
Warning	Geometry	2 - Pembury Rd West - Roundabout Geometry	Effective flare length is over 30m, which is outside the normal range. Treat capacities with increasing caution.
Warning	Vehicle Mix		HV% is zero for all movements / time segments. Vehicle Mix matrix should be completed whether working in PCUs or Vehs. If HV% at the junction is genuinely zero, please ignore this warning.

## Junction Network

### Junctions

Junction	Name	Junction type	Use circulating lanes	Arm order	Junction Delay (s)	Junction LOS
1	untitled	Standard Roundabout		1, 2, 3	9.79	A

### Junction Network

Driving side	Lighting	Network delay (s)	Network LOS
Left	Normal/unknown	9.79	A

## Traffic Demand

### Demand Set Details

ID	Scenario name	Time Period name	Traffic profile type	Start time (HH:mm)	Finish time (HH:mm)	Time segment length (min)	Run automatically
D4	Option 2 Demand	PM	ONE HOUR	16:45	18:15	15	✓

### Demand overview (Traffic)

Arm	Linked arm	Profile type	Use O-D data	Av. Demand (PCU/hr)	Scaling Factor (%)
1 - Pembury Rd East		ONE HOUR	✓	1648	100.000
2 - Pembury Rd West		ONE HOUR	✓	1804	100.000
3 - A21		ONE HOUR	✓	560	100.000

## Origin-Destination Data

### Demand (PCU/hr)

		To		
		1 - Pembury Rd East	2 - Pembury Rd West	3 - A21
From	1 - Pembury Rd East	0	1438	210
	2 - Pembury Rd West	1349	0	455
	3 - A21	37	523	0

## Vehicle Mix

HV data entry mode	PCU Factor for a HV (PCU)
HV Percentages	2.00

**Heavy Vehicle %**

		To		
		1 - Pembury Rd East	2 - Pembury Rd West	3 - A21
From	1 - Pembury Rd East	0	0	0
	2 - Pembury Rd West	0	0	0
	3 - A21	0	0	0

## Results

**Results Summary for whole modelled period**

Arm	Max RFC	Max Delay (s)	Max Q (PCU)	Max LOS	Av. Demand (PCU/hr)	Total Junction Arrivals (PCU)
1 - Pembury Rd East	0.90	16.59	8.0	C	1512	2268
2 - Pembury Rd West	0.75	5.39	2.9	A	1655	2483
3 - A21	0.40	3.97	0.7	A	514	771

**Appendix H**  
**Halls Hole Road Junction Existing Layout Modelling Results**

Full Input Data And Results  
Full Input Data And Results

User and Project Details

Project:	
Title:	
Location:	
Additional detail:	
File name:	Halls Hole Road Signal Junction (Existing Layout).lsg3x
Author:	
Company:	
Address:	

Network Layout Diagram

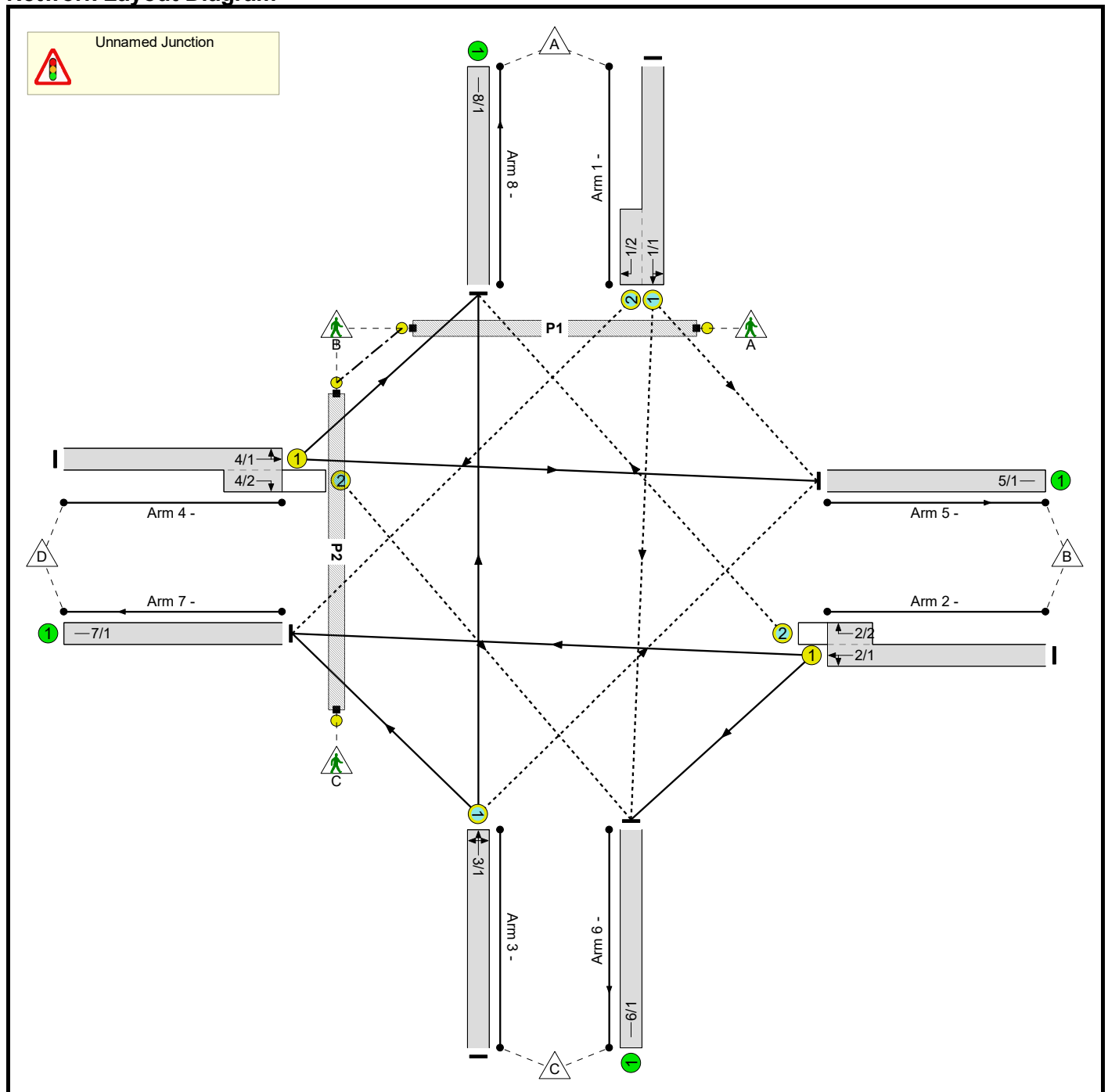

**Phase Diagram**

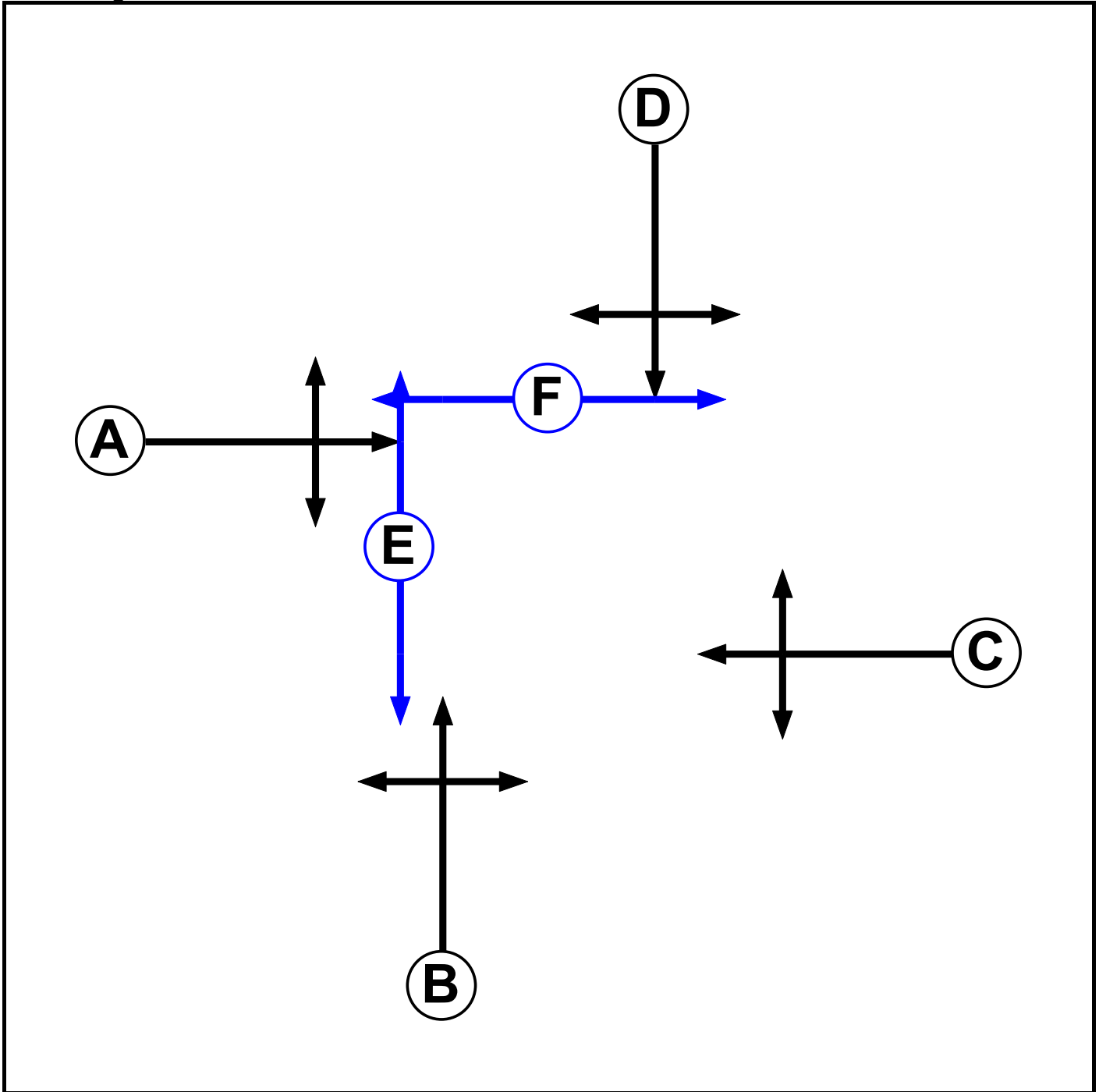

**Phase Input Data**

Phase Name	Phase Type	Assoc. Phase	Street Min	Cont Min
A	Traffic		7	7
B	Traffic		7	7
C	Traffic		7	7
D	Traffic		7	7
E	Pedestrian		7	7
F	Pedestrian		7	7

Full Input Data And Results

**Phase Intergrens Matrix**

		Starting Phase					
		A	B	C	D	E	F
Terminating Phase	A		6	-	7	5	7
	B	6		5	-	7	8
	C	-	6		6	8	8
	D	6	-	6		8	5
	E	8	8	8	8		-
	F	8	8	8	8	-	

**Phases in Stage**

Stage No.	Phases in Stage
1	A C
2	E F
3	B D

**Stage Diagram**

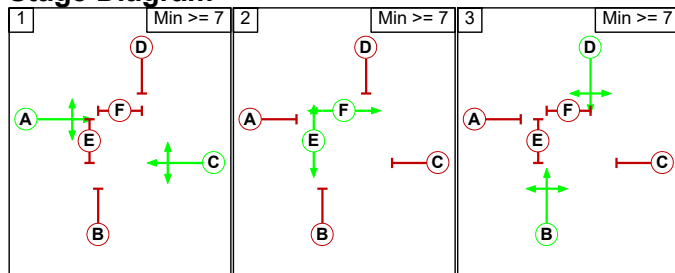

**Phase Delays**

Term. Stage	Start Stage	Phase	Type	Value	Cont value
There are no Phase Delays defined					

**Prohibited Stage Change**

		To Stage		
		1	2	3
From Stage	1		8	7
	2	8		8
	3	6	8	



Full Input Data And Results

**Give-Way Lane Input Data**

Junction: Unnamed Junction											
Lane	Movement	Max Flow when Giving Way (PCU/Hr)	Min Flow when Giving Way (PCU/Hr)	Opposing Lane	Opp. Lane Coeff.	Opp. Mvmnts.	Right Turn Storage (PCU)	Non-Blocking Storage (PCU)	RTF	Right Turn Move up (s)	Max Turns in Intergreen (PCU)
1/1	5/1 (Left)	1439	0	3/1	1.09	To 5/1 (Right)	-	-	-	-	-
	6/1 (Ahead)	1439	0	3/1	1.09	To 5/1 (Right)					
1/2	7/1 (Right)	1439	0	3/1	1.09	To 7/1 (Left) To 8/1 (Ahead)	-	-	-	-	-
2/2	8/1 (Right)	1439	0	4/1	1.09	All	2.00	-	0.50	2	2.00
3/1	5/1 (Right)	1439	0	1/1	1.09	All	-	-	-	-	-
4/2	6/1 (Right)	1439	0	2/1	1.09	All	3.00	-	0.50	3	3.00

Full Input Data And Results

**Lane Input Data**

Junction: Unnamed Junction												
Lane	Lane Type	Phases	Start Disp.	End Disp.	Physical Length (PCU)	Sat Flow Type	Def User Saturation Flow (PCU/Hr)	Lane Width (m)	Gradient	Nearside Lane	Turns	Turning Radius (m)
1/1	O	D	2	3	60.0	Geom	-	2.68	0.00	Y	Arm 5 Left	14.80
											Arm 6 Ahead	Inf
1/2	O	D	2	3	5.2	Geom	-	2.83	0.00	Y	Arm 7 Right	14.90
2/1	U	C	2	3	60.0	Geom	-	3.42	0.00	Y	Arm 6 Left	6.40
											Arm 7 Ahead	Inf
2/2	O	C	2	3	3.1	Geom	-	3.23	0.00	Y	Arm 8 Right	13.20
3/1	O	B	2	3	60.0	Geom	-	3.10	0.00	Y	Arm 5 Right	9.00
											Arm 7 Left	19.00
											Arm 8 Ahead	Inf
4/1	U	A	2	3	60.0	Geom	-	3.12	0.00	Y	Arm 5 Ahead	Inf
4/2	O	A	2	3	4.0	Geom	-	2.80	0.00	Y	Arm 8 Left	8.30
											Arm 6 Right	9.40
5/1	U		2	3	60.0	Inf	-	-	-	-	-	-
6/1	U		2	3	60.0	Inf	-	-	-	-	-	-
7/1	U		2	3	60.0	Inf	-	-	-	-	-	-
8/1	U		2	3	60.0	Inf	-	-	-	-	-	-

**Traffic Flow Groups**

Flow Group	Start Time	End Time	Duration	Formula
1: 'Option 1 AM Demand'	07:30	08:30	01:00	
2: 'Option 1 PM Demand'	16:45	17:45	01:00	
3: 'Option 2 AM Demand'	07:30	08:30	01:00	
4: 'Option 2 PM Demand'	16:45	17:45	01:00	

**Scenario 1: 'Option 1 AM Demand'** (FG1: 'Option 1 AM Demand', Plan 1: 'Network Control Plan 1')

**Traffic Flows, Desired**

**Desired Flow :**

Origin	Destination					
	A	B	C	D	Tot.	
A	0	101	15	106	222	
B	74	0	327	1428	1829	
C	13	337	0	0	350	
D	120	1493	50	0	1663	
Tot.	207	1931	392	1534	4064	

Full Input Data And Results

**Traffic Lane Flows**

Lane	Scenario 1: Option 1 AM Demand
<b>Junction: Unnamed Junction</b>	
1/1 (with short)	222(In) 116(Out)
1/2 (short)	106
2/1 (with short)	1829(In) 1755(Out)
2/2 (short)	74
3/1	350
4/1 (with short)	1663(In) 1613(Out)
4/2 (short)	50
5/1	1931
6/1	392
7/1	1534
8/1	207

**Lane Saturation Flows**

<b>Junction: Unnamed Junction</b>								
Lane	Lane Width (m)	Gradient	Nearside Lane	Allowed Turns	Turning Radius (m)	Turning Prop.	Sat Flow (PCU/Hr)	Flared Sat Flow (PCU/Hr)
1/1	2.68	0.00	Y	Arm 5 Left Arm 6 Ahead	14.80 Inf	87.1 % 12.9 %	1731	1731
1/2	2.83	0.00	Y	Arm 7 Right	14.90	100.0 %	1725	1725
2/1	3.42	0.00	Y	Arm 6 Left Arm 7 Ahead	6.40 Inf	18.6 % 81.4 %	1875	1875
2/2	3.23	0.00	Y	Arm 8 Right	13.20	100.0 %	1740	1740
3/1	3.10	0.00	Y	Arm 5 Right Arm 7 Left Arm 8 Ahead	9.00 19.00 Inf	96.3 % 0.0 % 3.7 %	1658	1658
4/1	3.12	0.00	Y	Arm 5 Ahead Arm 8 Left	Inf 8.30	92.6 % 7.4 %	1902	1902
4/2	2.80	0.00	Y	Arm 6 Right	9.40	100.0 %	1634	1634
5/1	Infinite Saturation Flow						Inf	Inf
6/1	Infinite Saturation Flow						Inf	Inf
7/1	Infinite Saturation Flow						Inf	Inf
8/1	Infinite Saturation Flow						Inf	Inf

Full Input Data And Results

**Scenario 2: 'Option 1 PM Demand'** (FG2: 'Option 1 PM Demand', Plan 1: 'Network Control Plan 1')

**Traffic Flows, Desired**

**Desired Flow :**

	Destination					
	A	B	C	D	Tot.	
Origin	0	50	23	19	92	
B	67	0	530	1317	1914	
C	53	265	0	0	318	
D	35	1399	86	0	1520	
Tot.	155	1714	639	1336	3844	

**Traffic Lane Flows**

Lane	Scenario 2: Option 1 PM Demand
<b>Junction: Unnamed Junction</b>	
1/1 (with short)	92(In) 73(Out)
1/2 (short)	19
2/1 (with short)	1914(In) 1847(Out)
2/2 (short)	67
3/1	318
4/1 (with short)	1520(In) 1434(Out)
4/2 (short)	86
5/1	1714
6/1	639
7/1	1336
8/1	155

Full Input Data And Results

**Lane Saturation Flows**

Junction: Unnamed Junction								
Lane	Lane Width (m)	Gradient	Nearside Lane	Allowed Turns	Turning Radius (m)	Turning Prop.	Sat Flow (PCU/Hr)	Flared Sat Flow (PCU/Hr)
1/1	2.68	0.00	Y	Arm 5 Left	14.80	68.5 %	1761	1761
				Arm 6 Ahead	Inf	31.5 %		
1/2	2.83	0.00	Y	Arm 7 Right	14.90	100.0 %	1725	1725
2/1	3.42	0.00	Y	Arm 6 Left	6.40	28.7 %	1834	1834
				Arm 7 Ahead	Inf	71.3 %		
2/2	3.23	0.00	Y	Arm 8 Right	13.20	100.0 %	1740	1740
3/1	3.10	0.00	Y	Arm 5 Right	9.00	83.3 %	1690	1690
				Arm 7 Left	19.00	0.0 %		
				Arm 8 Ahead	Inf	16.7 %		
4/1	3.12	0.00	Y	Arm 5 Ahead	Inf	97.6 %	1919	1919
				Arm 8 Left	8.30	2.4 %		
4/2	2.80	0.00	Y	Arm 6 Right	9.40	100.0 %	1634	1634
5/1	Infinite Saturation Flow						Inf	Inf
6/1	Infinite Saturation Flow						Inf	Inf
7/1	Infinite Saturation Flow						Inf	Inf
8/1	Infinite Saturation Flow						Inf	Inf

**Scenario 3: 'Option 2 AM Demand'** (FG3: 'Option 2 AM Demand', Plan 1: 'Network Control Plan 1')

**Traffic Flows, Desired**

**Desired Flow :**

	Destination					
		A	B	C	D	Tot.
Origin	A	0	101	15	106	222
	B	72	0	326	1457	1855
	C	14	405	0	0	419
	D	121	1575	86	0	1782
	Tot.	207	2081	427	1563	4278

Full Input Data And Results

**Traffic Lane Flows**

Lane	Scenario 3: Option 2 AM Demand
<b>Junction: Unnamed Junction</b>	
1/1 (with short)	222(In) 116(Out)
1/2 (short)	106
2/1 (with short)	1855(In) 1783(Out)
2/2 (short)	72
3/1	419
4/1 (with short)	1782(In) 1696(Out)
4/2 (short)	86
5/1	2081
6/1	427
7/1	1563
8/1	207

**Lane Saturation Flows**

<b>Junction: Unnamed Junction</b>								
Lane	Lane Width (m)	Gradient	Nearside Lane	Allowed Turns	Turning Radius (m)	Turning Prop.	Sat Flow (PCU/Hr)	Flared Sat Flow (PCU/Hr)
1/1	2.68	0.00	Y	Arm 5 Left Arm 6 Ahead	14.80 Inf	87.1 % 12.9 %	1731	1731
1/2	2.83	0.00	Y	Arm 7 Right	14.90	100.0 %	1725	1725
2/1	3.42	0.00	Y	Arm 6 Left Arm 7 Ahead	6.40 Inf	18.3 % 81.7 %	1877	1877
2/2	3.23	0.00	Y	Arm 8 Right	13.20	100.0 %	1740	1740
3/1	3.10	0.00	Y	Arm 5 Right Arm 7 Left Arm 8 Ahead	9.00 19.00 Inf	96.7 % 0.0 % 3.3 %	1657	1657
4/1	3.12	0.00	Y	Arm 5 Ahead Arm 8 Left	Inf 8.30	92.9 % 7.1 %	1903	1903
4/2	2.80	0.00	Y	Arm 6 Right	9.40	100.0 %	1634	1634
5/1	Infinite Saturation Flow						Inf	Inf
6/1	Infinite Saturation Flow						Inf	Inf
7/1	Infinite Saturation Flow						Inf	Inf
8/1	Infinite Saturation Flow						Inf	Inf

Full Input Data And Results

**Scenario 4: 'Option 2 PM Demand'** (FG4: 'Option 2 PM Demand', Plan 1: 'Network Control Plan 1')

**Traffic Flows, Desired**

**Desired Flow :**

	Destination					
	A	B	C	D	Tot.	
Origin	0	50	23	19	92	
B	67	0	518	1376	1961	
C	53	317	0	0	370	
D	35	1437	168	0	1640	
Tot.	155	1804	709	1395	4063	

**Traffic Lane Flows**

Lane	Scenario 4: Option 2 PM Demand
<b>Junction: Unnamed Junction</b>	
1/1 (with short)	92(In) 73(Out)
1/2 (short)	19
2/1 (with short)	1961(In) 1894(Out)
2/2 (short)	67
3/1	370
4/1 (with short)	1640(In) 1472(Out)
4/2 (short)	168
5/1	1804
6/1	709
7/1	1395
8/1	155

**Lane Saturation Flows**

Junction: Unnamed Junction								
Lane	Lane Width (m)	Gradient	Nearside Lane	Allowed Turns	Turning Radius (m)	Turning Prop.	Sat Flow (PCU/Hr)	Flared Sat Flow (PCU/Hr)
1/1	2.68	0.00	Y	Arm 5 Left	14.80	68.5 %	1761	1761
				Arm 6 Ahead	Inf	31.5 %		
1/2	2.83	0.00	Y	Arm 7 Right	14.90	100.0 %	1725	1725
2/1	3.42	0.00	Y	Arm 6 Left	6.40	27.3 %	1839	1839
				Arm 7 Ahead	Inf	72.7 %		
2/2	3.23	0.00	Y	Arm 8 Right	13.20	100.0 %	1740	1740
3/1	3.10	0.00	Y	Arm 5 Right	9.00	85.7 %	1684	1684
				Arm 7 Left	19.00	0.0 %		
4/1	3.12	0.00	Y	Arm 8 Ahead	Inf	97.6 %	1919	1919
				Arm 6 Right	9.40	100.0 %		
4/2	2.80	0.00	Y	Arm 5 Ahead	Inf	2.4 %	1634	1634
5/1	Infinite Saturation Flow						Inf	Inf
6/1	Infinite Saturation Flow						Inf	Inf
7/1	Infinite Saturation Flow						Inf	Inf
8/1	Infinite Saturation Flow						Inf	Inf

**Scenario 1: 'Option 1 AM Demand' (FG1: 'Option 1 AM Demand', Plan 1: 'Network Control Plan 1')**

**Stage Sequence Diagram**

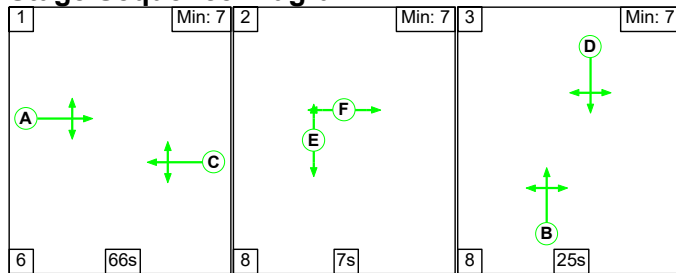

**Stage Timings**

Stage	1	2	3
Duration	66	7	25
Change Point	0	72	87



### Signal Timings Diagram

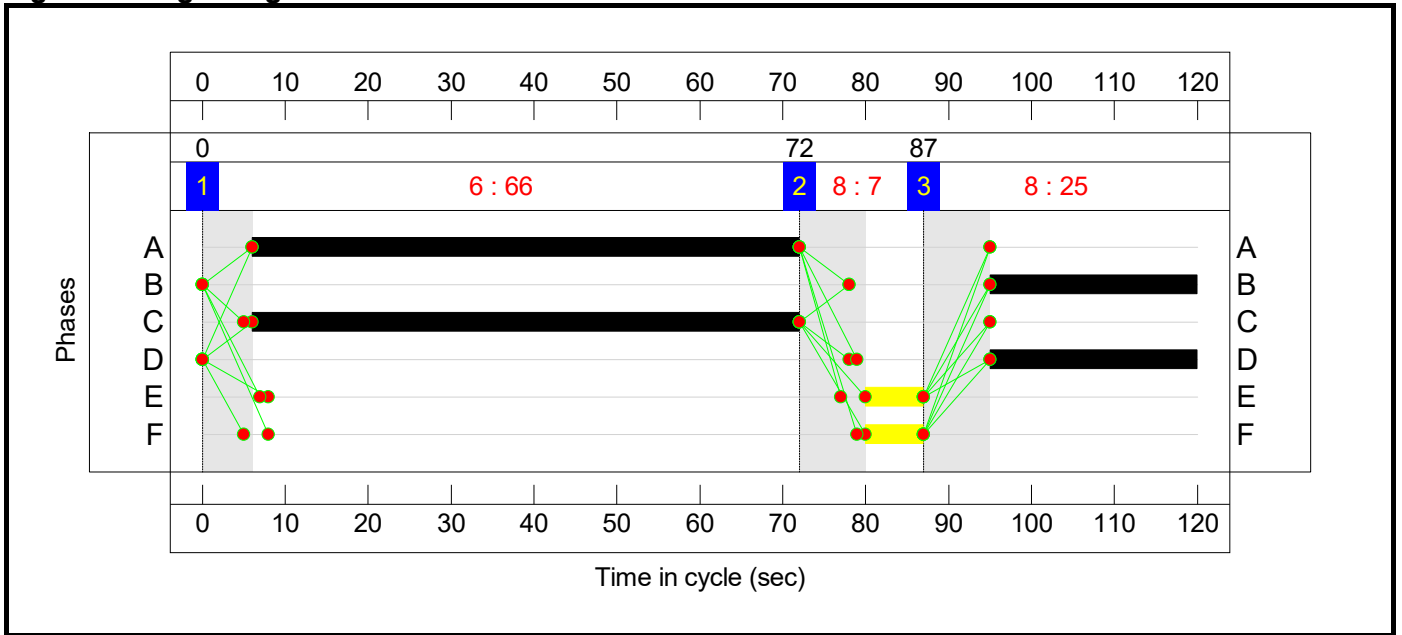

Full Input Data And Results  
**Network Layout Diagram**

Full Input Data And Results

Unnamed Junction  
PRC: -94.4 %  
Total Traffic Delay: 897.7 pcuHr  
Ave. Route Delay Per Ped: 0.0 s/Ped

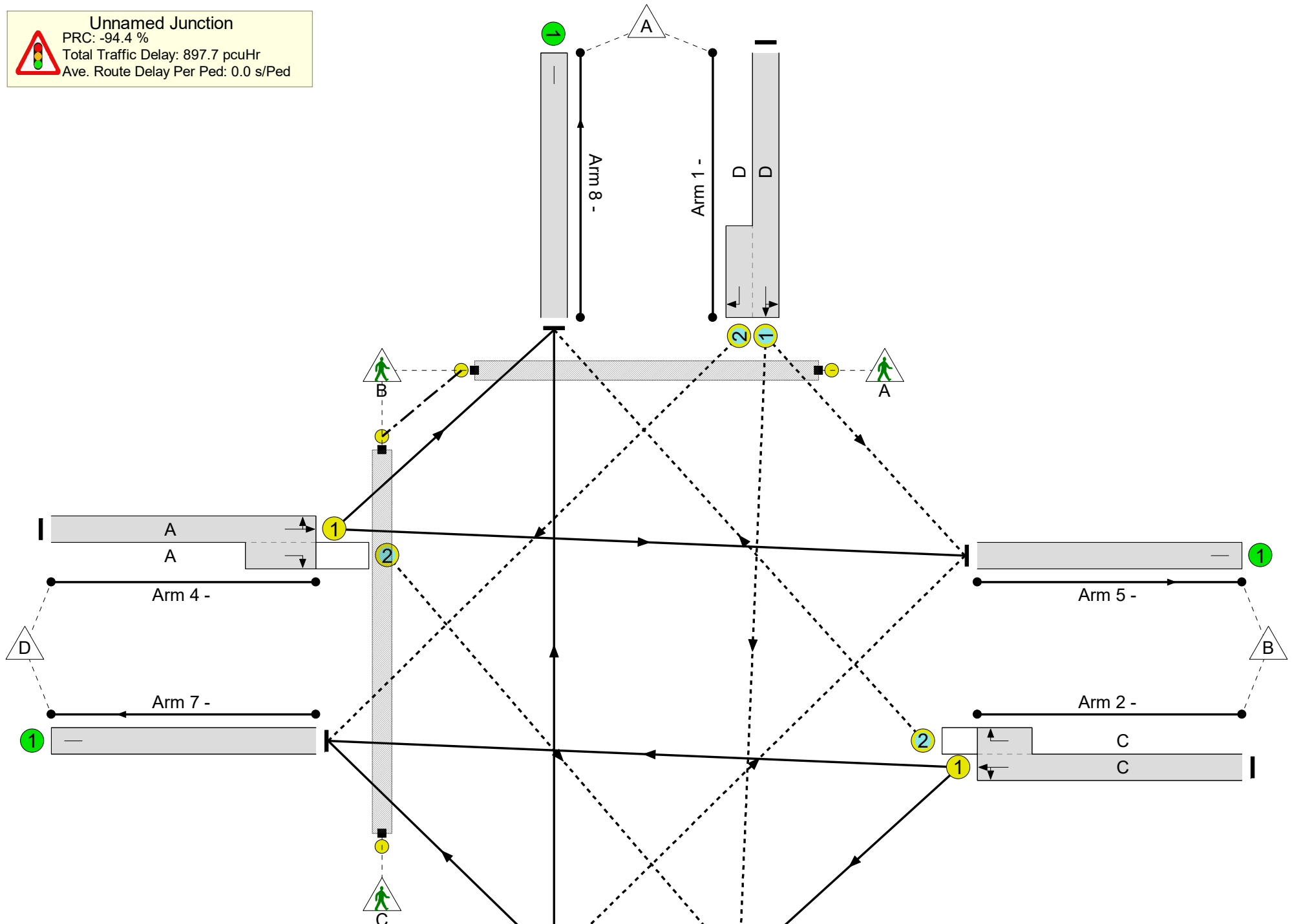

Full Input Data And Results

**Network Results**

Item	Lane Description	Lane Type	Controller Stream	Position In Filtered Route	Full Phase	Arrow Phase	Num Greens	Total Green (s)	Arrow Green (s)	Demand Flow (pcu)	Sat Flow (pcu/Hr)	Capacity (pcu)	Deg Sat (%)
Network	-	-	N/A	-	-		-	-	-	-	-	-	174.9%
Unnamed Junction	-	-	N/A	-	-		-	-	-	-	-	-	174.9%
1/1+1/2	Left Ahead Right	O	N/A	N/A	D		1	25	-	222	1731:1725	138+126	84.3 : 84.3%
2/1+2/2	Left Ahead Right	U+O	N/A	N/A	C		1	66	-	1829	1875:1740	1003+42	174.9 : 174.9%
3/1	Right Left Ahead	O	N/A	N/A	B		1	25	-	350	1658	204	171.6%
4/1+4/2	Ahead Right Left	U+O	N/A	N/A	A		1	66	-	1663	1902:1634	1023+32	157.7 : 157.7%
5/1		U	N/A	N/A	-		-	-	-	1931	Inf	Inf	0.0%
6/1		U	N/A	N/A	-		-	-	-	392	Inf	Inf	0.0%
7/1		U	N/A	N/A	-		-	-	-	1534	Inf	Inf	0.0%
8/1		U	N/A	N/A	-		-	-	-	207	Inf	Inf	0.0%
Ped Link: P1	Unnamed Ped Link	-	N/A	-	F		1	7	-	0	-	4200	0.0%
Ped Link: P2	Unnamed Ped Link	-	N/A	-	E		1	7	-	0	-	4200	0.0%

Full Input Data And Results

Item	Arriving (pcu)	Leaving (pcu)	Turners In Gaps (pcu)	Turners When Unopposed (pcu)	Turners In Intergreen (pcu)	Uniform Delay (pcuHr)	Rand + Oversat Delay (pcuHr)	Storage Area Uniform Delay (pcuHr)	Total Delay (pcuHr)	Av. Delay Per PCU (s/pcu)	Max. Back of Uniform Queue (pcu)	Rand + Oversat Queue (pcu)	Mean Max Queue (pcu)
<b>Network</b>	-	-	<b>501</b>	<b>142</b>	<b>72</b>	<b>121.8</b>	<b>775.2</b>	<b>0.7</b>	<b>897.7</b>	-	-	-	-
<b>Unnamed Junction</b>	-	-	<b>501</b>	<b>142</b>	<b>72</b>	<b>121.8</b>	<b>775.2</b>	<b>0.7</b>	<b>897.7</b>	-	-	-	-
1/1+1/2	222	222	329	115	0	2.7	2.4	-	5.1	82.0	3.7	2.4	6.1
2/1+2/2	1829	1046	2	0	40	58.5	392.9	0.4	451.7	889.1	90.2	392.9	483.1
3/1	350	204	170	27	0	14.8	74.2	-	89.0	915.5	21.1	74.2	95.3
4/1+4/2	1663	1054	0	0	32	45.9	305.7	0.3	351.9	761.8	77.4	305.7	383.2
5/1	1244	1244	-	-	-	0.0	0.0	-	0.0	0.0	0.0	0.0	0.0
6/1	234	234	-	-	-	0.0	0.0	-	0.0	0.0	0.0	0.0	0.0
7/1	922	922	-	-	-	0.0	0.0	-	0.0	0.0	0.0	0.0	0.0
8/1	126	126	-	-	-	0.0	0.0	-	0.0	0.0	0.0	0.0	0.0
Ped Link: P1	0	0	-	-	-	-	-	-	0.0	0.0	-	-	0.0
Ped Link: P2	0	0	-	-	-	-	-	-	0.0	0.0	-	-	0.0
C1			PRC for Signalled Lanes (%): -94.4		PRC Over All Lanes (%): -94.4		Total Delay for Signalled Lanes (pcuHr): 897.72		Total Delay Over All Lanes(pcuHr): 897.72		Cycle Time (s): 120		

Full Input Data And Results

Scenario 2: 'Option 1 PM Demand' (FG2: 'Option 1 PM Demand', Plan 1: 'Network Control Plan 1')

Stage Sequence Diagram

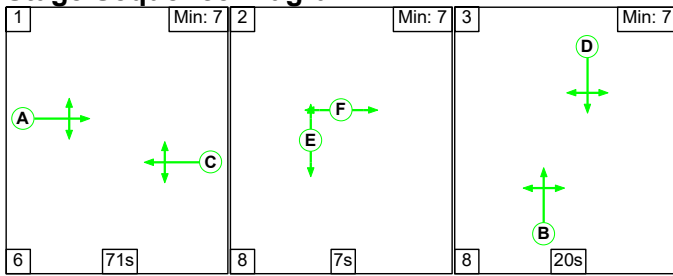

Stage Timings

Stage	1	2	3
Duration	71	7	20
Change Point	0	77	92

Signal Timings Diagram

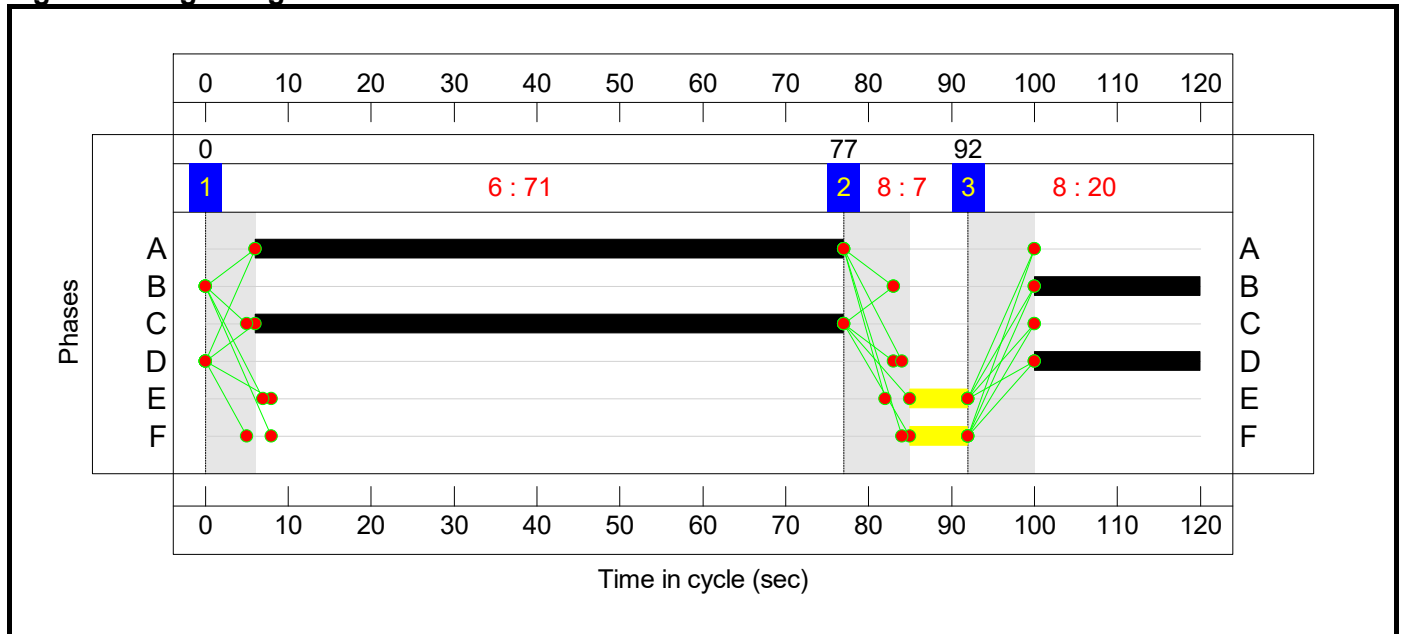

Full Input Data And Results  
**Network Layout Diagram**

Full Input Data And Results

Unnamed Junction  
PRC: -93.0 %  
Total Traffic Delay: 771.0 pcuHr  
Ave. Route Delay Per Ped: 0.0 s/Ped

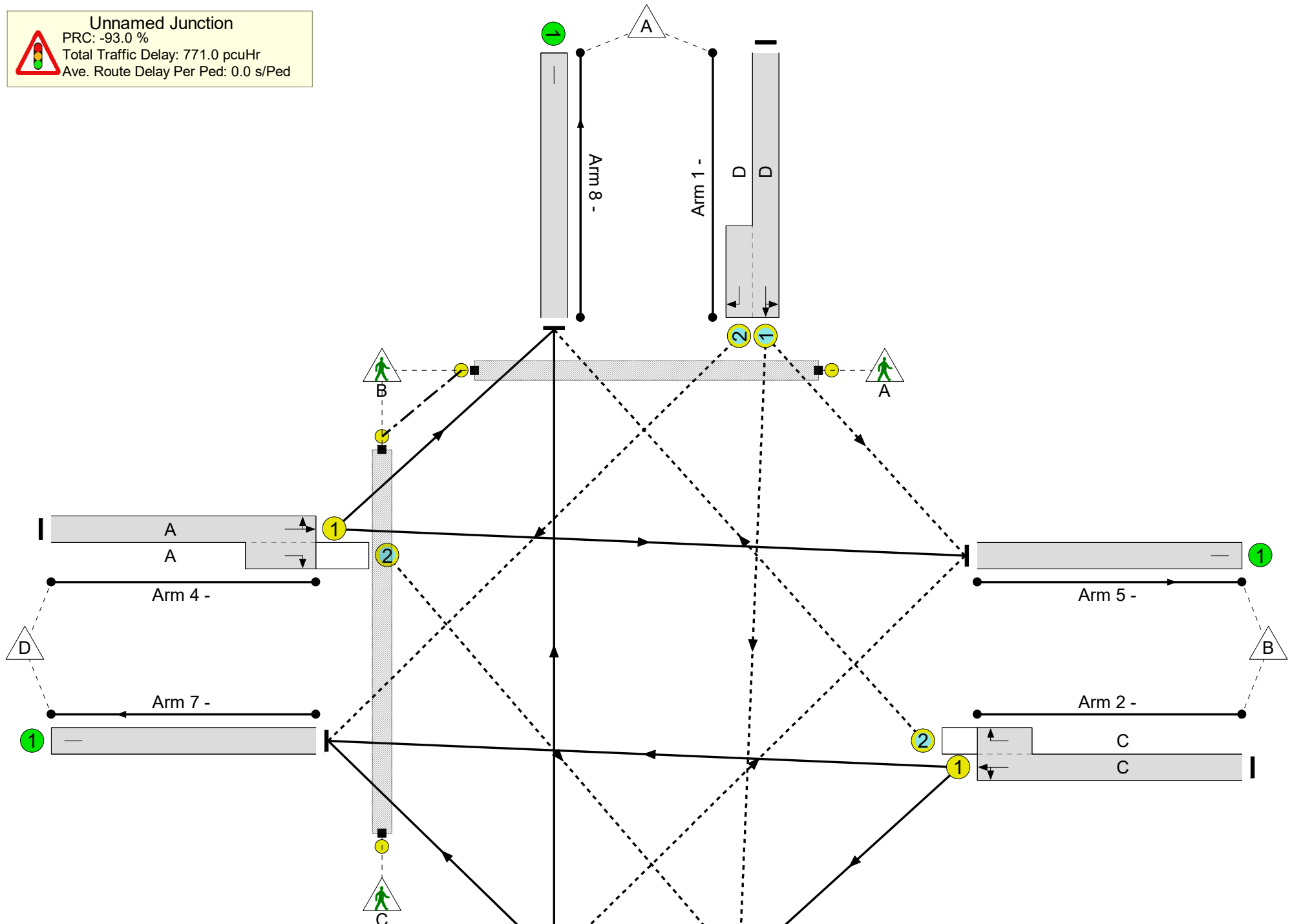



Full Input Data And Results

**Network Results**

Item	Lane Description	Lane Type	Controller Stream	Position In Filtered Route	Full Phase	Arrow Phase	Num Greens	Total Green (s)	Arrow Green (s)	Demand Flow (pcu)	Sat Flow (pcu/Hr)	Capacity (pcu)	Deg Sat (%)
Network	-	-	N/A	-	-		-	-	-	-	-	-	173.7%
Unnamed Junction	-	-	N/A	-	-		-	-	-	-	-	-	173.7%
1/1+1/2	Left Ahead Right	O	N/A	N/A	D		1	20	-	92	1761:1725	105+27	69.8 : 69.8%
2/1+2/2	Left Ahead Right	U+O	N/A	N/A	C		1	71	-	1914	1834:1740	1063+39	173.7 : 173.7%
3/1	Right Left Ahead	O	N/A	N/A	B		1	20	-	318	1690	193	164.6%
4/1+4/2	Ahead Right Left	U+O	N/A	N/A	A		1	71	-	1520	1919:1634	1076+65	133.3 : 133.3%
5/1		U	N/A	N/A	-		-	-	-	1714	Inf	Inf	0.0%
6/1		U	N/A	N/A	-		-	-	-	639	Inf	Inf	0.0%
7/1		U	N/A	N/A	-		-	-	-	1336	Inf	Inf	0.0%
8/1		U	N/A	N/A	-		-	-	-	155	Inf	Inf	0.0%
Ped Link: P1	Unnamed Ped Link	-	N/A	-	F		1	7	-	0	-	4200	0.0%
Ped Link: P2	Unnamed Ped Link	-	N/A	-	E		1	7	-	0	-	4200	0.0%

Full Input Data And Results

Item	Arriving (pcu)	Leaving (pcu)	Turners In Gaps (pcu)	Turners When Unopposed (pcu)	Turners In Intergreen (pcu)	Uniform Delay (pcuHr)	Rand + Oversat Delay (pcuHr)	Storage Area Uniform Delay (pcuHr)	Total Delay (pcuHr)	Av. Delay Per PCU (s/pcu)	Max. Back of Uniform Queue (pcu)	Rand + Oversat Queue (pcu)	Mean Max Queue (pcu)
Network	-	-	234	114	100	106.2	663.7	1.0	771.0	-	-	-	-
Unnamed Junction	-	-	234	114	100	106.2	663.7	1.0	771.0	-	-	-	-
1/1+1/2	92	92	93	91	0	1.1	1.1	-	2.2	86.3	2.2	1.1	3.3
2/1+2/2	1914	1102	3	0	35	61.3	407.3	0.3	469.0	882.0	96.6	407.3	503.9
3/1	318	193	138	23	0	13.0	63.6	-	76.7	867.9	18.7	63.6	82.3
4/1+4/2	1520	1141	0	0	65	30.8	191.7	0.7	223.2	528.5	64.8	191.7	256.4
5/1	1261	1261	-	-	-	0.0	0.0	-	0.0	0.0	0.0	0.0	0.0
6/1	393	393	-	-	-	0.0	0.0	-	0.0	0.0	0.0	0.0	0.0
7/1	777	777	-	-	-	0.0	0.0	-	0.0	0.0	0.0	0.0	0.0
8/1	97	97	-	-	-	0.0	0.0	-	0.0	0.0	0.0	0.0	0.0
Ped Link: P1	0	0	-	-	-	-	-	-	0.0	0.0	-	-	0.0
Ped Link: P2	0	0	-	-	-	-	-	-	0.0	0.0	-	-	0.0
C1			PRC for Signalled Lanes (%):		-93.0	Total Delay for Signalled Lanes (pcuHr):		770.98	Cycle Time (s):		120		
			PRC Over All Lanes (%):		-93.0	Total Delay Over All Lanes(pcuHr):		770.98					

Full Input Data And Results

Scenario 3: 'Option 2 AM Demand' (FG3: 'Option 2 AM Demand', Plan 1: 'Network Control Plan 1')

Stage Sequence Diagram

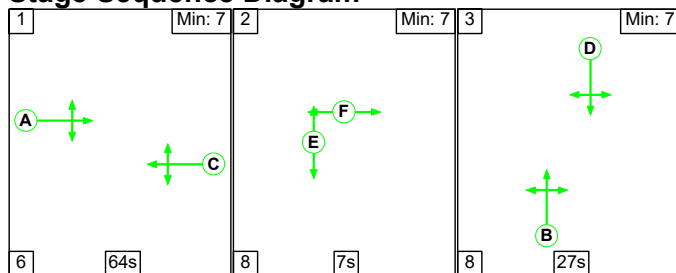

Stage Timings

Stage	1	2	3
Duration	64	7	27
Change Point	0	70	85

Signal Timings Diagram

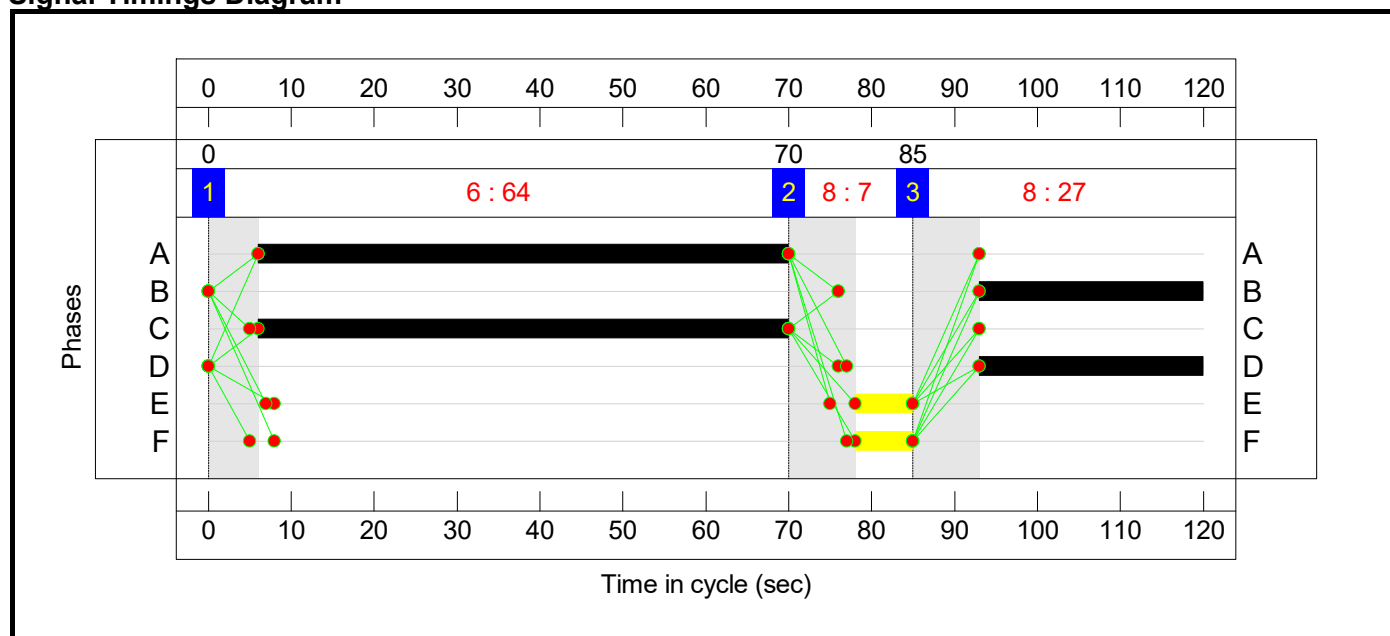

Full Input Data And Results  
**Network Layout Diagram**

Full Input Data And Results

Unnamed Junction  
PRC: -104.3 %  
Total Traffic Delay: 1041.8 pcuHr  
Ave. Route Delay Per Ped: 0.0 s/Ped

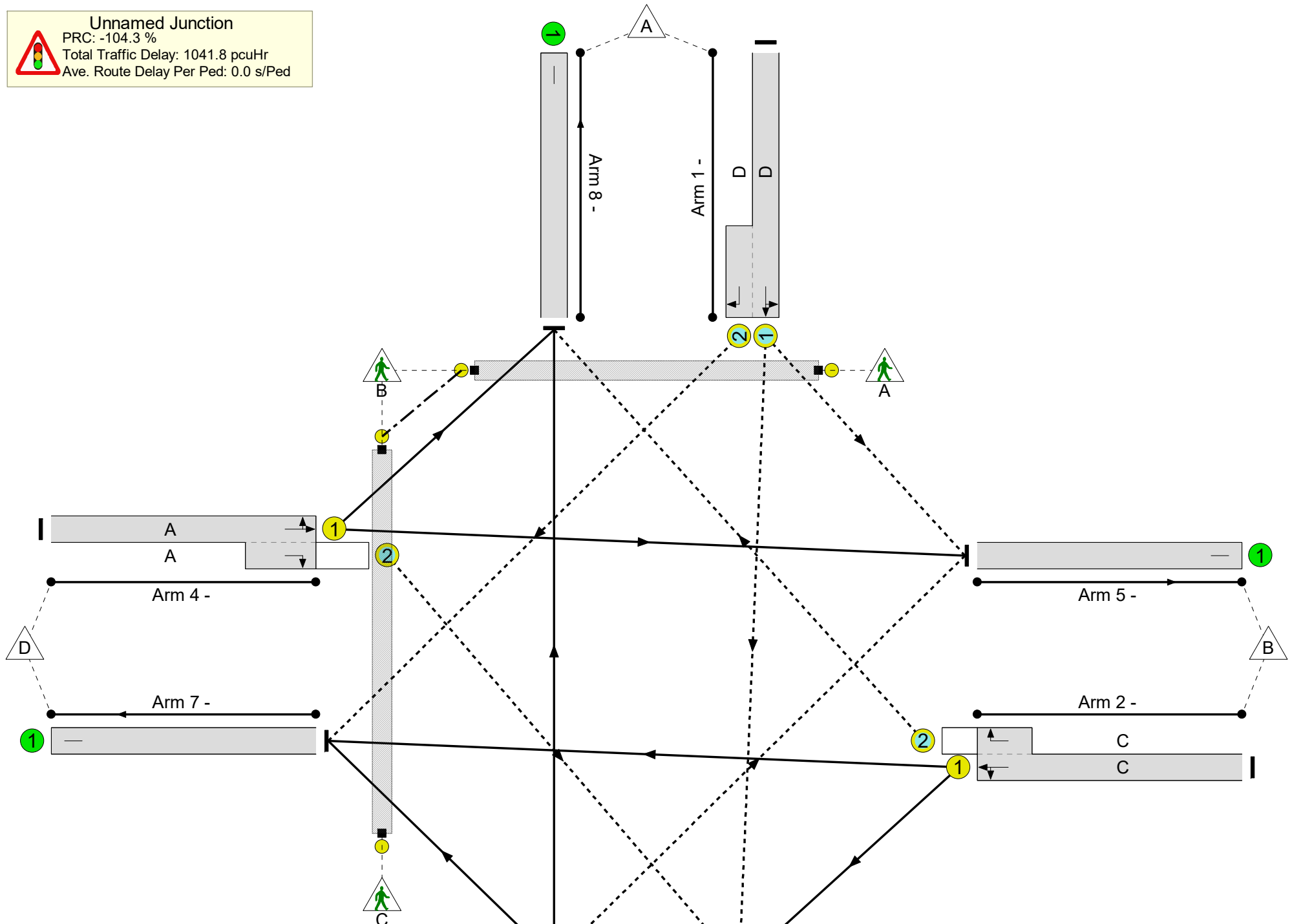

Full Input Data And Results

**Network Results**

Item	Lane Description	Lane Type	Controller Stream	Position In Filtered Route	Full Phase	Arrow Phase	Num Greens	Total Green (s)	Arrow Green (s)	Demand Flow (pcu)	Sat Flow (pcu/Hr)	Capacity (pcu)	Deg Sat (%)
Network	-	-	N/A	-	-		-	-	-	-	-	-	183.8%
Unnamed Junction	-	-	N/A	-	-		-	-	-	-	-	-	183.8%
1/1+1/2	Left Ahead Right	O	N/A	N/A	D		1	27	-	222	1731:1725	138+126	84.3 : 84.3%
2/1+2/2	Left Ahead Right	U+O	N/A	N/A	C		1	64	-	1855	1877:1740	976+39	182.7 : 182.7%
3/1	Right Left Ahead	O	N/A	N/A	B		1	27	-	419	1657	228	183.8%
4/1+4/2	Ahead Right Left	U+O	N/A	N/A	A		1	64	-	1782	1903:1634	974+49	174.2 : 174.2%
5/1		U	N/A	N/A	-		-	-	-	2081	Inf	Inf	0.0%
6/1		U	N/A	N/A	-		-	-	-	427	Inf	Inf	0.0%
7/1		U	N/A	N/A	-		-	-	-	1563	Inf	Inf	0.0%
8/1		U	N/A	N/A	-		-	-	-	207	Inf	Inf	0.0%
Ped Link: P1	Unnamed Ped Link	-	N/A	-	F		1	7	-	0	-	4200	0.0%
Ped Link: P2	Unnamed Ped Link	-	N/A	-	E		1	7	-	0	-	4200	0.0%



Full Input Data And Results

Scenario 4: 'Option 2 PM Demand' (FG4: 'Option 2 PM Demand', Plan 1: 'Network Control Plan 1')

Stage Sequence Diagram

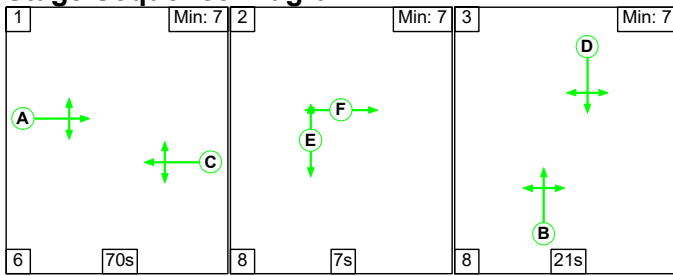

Stage Timings

Stage	1	2	3
Duration	70	7	21
Change Point	0	76	91

Signal Timings Diagram

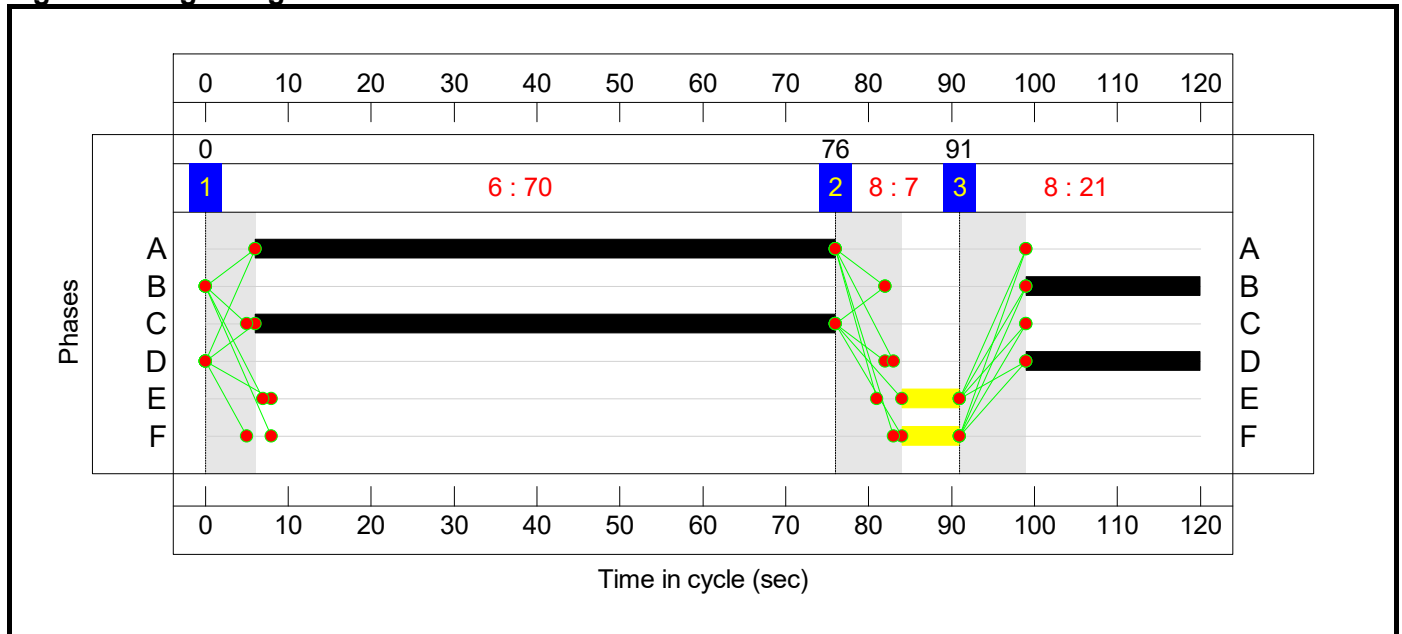



Full Input Data And Results  
**Network Layout Diagram**

Full Input Data And Results

**Unnamed Junction**  
PRC: -107.4 %  
Total Traffic Delay: 920.6 pcuHr  
Ave. Route Delay Per Ped: 0.0 s/Ped

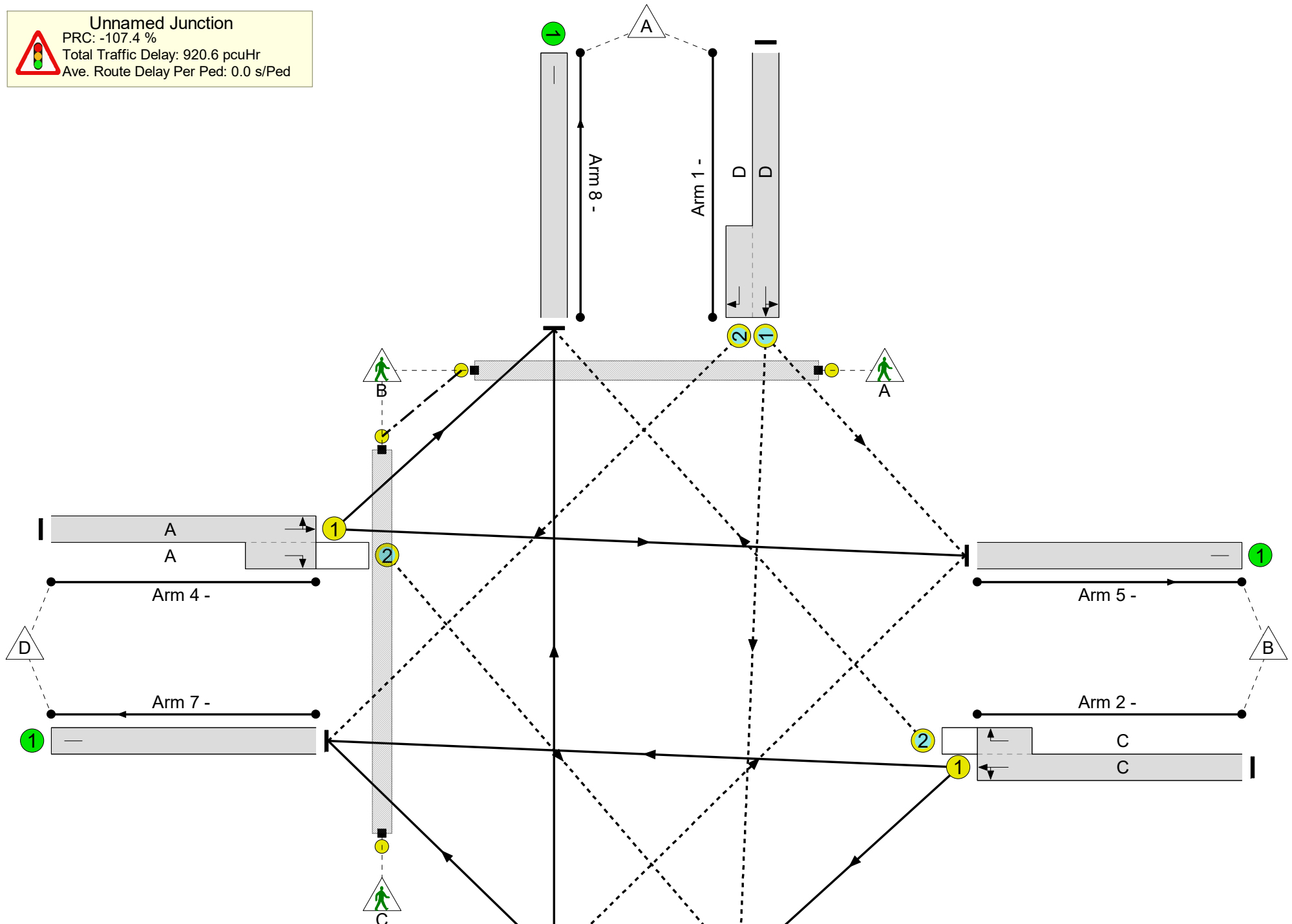

Full Input Data And Results

**Network Results**

Item	Lane Description	Lane Type	Controller Stream	Position In Filtered Route	Full Phase	Arrow Phase	Num Greens	Total Green (s)	Arrow Green (s)	Demand Flow (pcu)	Sat Flow (pcu/Hr)	Capacity (pcu)	Deg Sat (%)
Network	-	-	N/A	-	-		-	-	-	-	-	-	186.7%
Unnamed Junction	-	-	N/A	-	-		-	-	-	-	-	-	186.7%
1/1+1/2	Left Ahead Right	O	N/A	N/A	D		1	21	-	92	1761:1725	102+27	71.5 : 71.5%
2/1+2/2	Left Ahead Right	U+O	N/A	N/A	C		1	70	-	1961	1839:1740	1052+37	180.1 : 180.1%
3/1	Right Left Ahead	O	N/A	N/A	B		1	21	-	370	1684	205	180.9%
4/1+4/2	Ahead Right Left	U+O	N/A	N/A	A		1	70	-	1640	1919:1634	1008+90	146.0 : 186.7%
5/1		U	N/A	N/A	-		-	-	-	1804	Inf	Inf	0.0%
6/1		U	N/A	N/A	-		-	-	-	709	Inf	Inf	0.0%
7/1		U	N/A	N/A	-		-	-	-	1395	Inf	Inf	0.0%
8/1		U	N/A	N/A	-		-	-	-	155	Inf	Inf	0.0%
Ped Link: P1	Unnamed Ped Link	-	N/A	-	F		1	7	-	0	-	4200	0.0%
Ped Link: P2	Unnamed Ped Link	-	N/A	-	E		1	7	-	0	-	4200	0.0%

Full Input Data And Results

Item	Arriving (pcu)	Leaving (pcu)	Turners In Gaps (pcu)	Turners When Unopposed (pcu)	Turners In Intergreen (pcu)	Uniform Delay (pcuHr)	Rand + Oversat Delay (pcuHr)	Storage Area Uniform Delay (pcuHr)	Total Delay (pcuHr)	Av. Delay Per PCU (s/pcu)	Max. Back of Uniform Queue (pcu)	Rand + Oversat Queue (pcu)	Mean Max Queue (pcu)
Network	-	-	248	114	124	124.3	794.4	1.9	920.6	-	-	-	-
Unnamed Junction	-	-	248	114	124	124.3	794.4	1.9	920.6	-	-	-	-
1/1+1/2	92	92	94	90	0	1.1	1.2	-	2.3	88.6	2.1	1.2	3.3
2/1+2/2	1961	1089	3	0	34	66.1	437.1	0.3	503.6	924.5	101.1	437.1	538.2
3/1	370	205	151	24	0	16.5	83.8	-	100.3	976.3	23.1	83.8	106.9
4/1+4/2	1640	1098	0	0	90	40.5	272.3	1.6	314.4	690.2	73.2	272.3	345.6
5/1	1210	1210	-	-	-	0.0	0.0	-	0.0	0.0	0.0	0.0	0.0
6/1	401	401	-	-	-	0.0	0.0	-	0.0	0.0	0.0	0.0	0.0
7/1	783	783	-	-	-	0.0	0.0	-	0.0	0.0	0.0	0.0	0.0
8/1	90	90	-	-	-	0.0	0.0	-	0.0	0.0	0.0	0.0	0.0
Ped Link: P1	0	0	-	-	-	-	-	-	0.0	0.0	-	-	0.0
Ped Link: P2	0	0	-	-	-	-	-	-	0.0	0.0	-	-	0.0
C1			PRC for Signalled Lanes (%): -107.4		PRC Over All Lanes (%): -107.4		Total Delay for Signalled Lanes (pcuHr): 920.62		Total Delay Over All Lanes(pcuHr): 920.62		Cycle Time (s): 120		

**Appendix I**  
**Halls Hole Road Junction Committed Roundabout Scheme Modelling Results**

Junctions 10
ARCADY 10 - Roundabout Module
Version: 10.1.1.1905 © Copyright TRL Software Limited, 2023
For sales and distribution information, program advice and maintenance, contact TRL Software: +44 (0)1344 379777 software@trl.co.uk trlsoftware.com
The users of this computer program for the solution of an engineering problem are in no way relieved of their responsibility for the correctness of the solution

**Filename:** Halls Hole Rbt Proposed Mitigation - Committed Rbt.j10  
**Path:** J:\332611481 - GH - Tunbridge Wells Local Plan\BRIEF 100 - Pembury Road\MODELLING\TRANSPORT\03. JUNCTIONS 10  
**Report generation date:** 14/05/2024 11:01:18

- »Option 1 Demand, AM
- »Option 1 Demand, PM
- »Option 2 Demand, AM
- »Option 2 Demand, PM

**Summary of junction performance**

	AM						PM					
	Set ID	Q (PCU)	Delay (s)	RFC	LOS	Junction Delay (s)	Set ID	Q (PCU)	Delay (s)	RFC	LOS	Junction Delay (s)
Option 1 Demand												
A - Pembury Rd (W)	D1	163.4	356.45	1.20	F	456.82	D2	71.5	138.37	1.07	F	448.17
B - Blackhurst Ln		4.9	77.63	0.86	F			0.6	22.91	0.38	C	
C - Pembury Rd (E)		301.8	676.15	1.31	F			361.6	786.97	1.35	F	
D - Hall's Hole Rd		2.9	28.06	0.74	D			1.2	12.85	0.54	B	
Option 2 Demand												
A - Pembury Rd (W)	D3	286.3	649.83	1.32	F	615.08	D4	154.2	331.49	1.19	F	648.07
B - Blackhurst Ln		7.1	112.67	0.93	F			0.7	25.03	0.41	D	
C - Pembury Rd (E)		343.1	768.71	1.34	F			453.5	1061.40	1.42	F	
D - Hall's Hole Rd		6.3	53.29	0.88	F			1.7	15.53	0.63	C	

There are warnings associated with one or more model runs - see the 'Data Errors and Warnings' tables for each Analysis or Demand Set.

Values shown are the highest values encountered over all time segments. Delay is the maximum value of Av. delay per arriving vehicle. Junction LOS and Junction Delay are demand-weighted Av.s.

**File summary**

**File Description**

<b>Title</b>	Halls Hole Rbt With Crossings
<b>Location</b>	Tunbridge Wells
<b>Site number</b>	
<b>Date</b>	11/01/2021
<b>Version</b>	
<b>Status</b>	(new file)
<b>Identifier</b>	
<b>Client</b>	Stantec
<b>Jobnumber</b>	20013
<b>Enumerator</b>	jct\simon.swanston
<b>Description</b>	

**Units**

Distance units	Speed units	Traffic units input	Traffic units results	Flow units	Av. delay units	Total delay units	Rate of delay units
m	kph	PCU	PCU	perHour	s	-Min	perMin

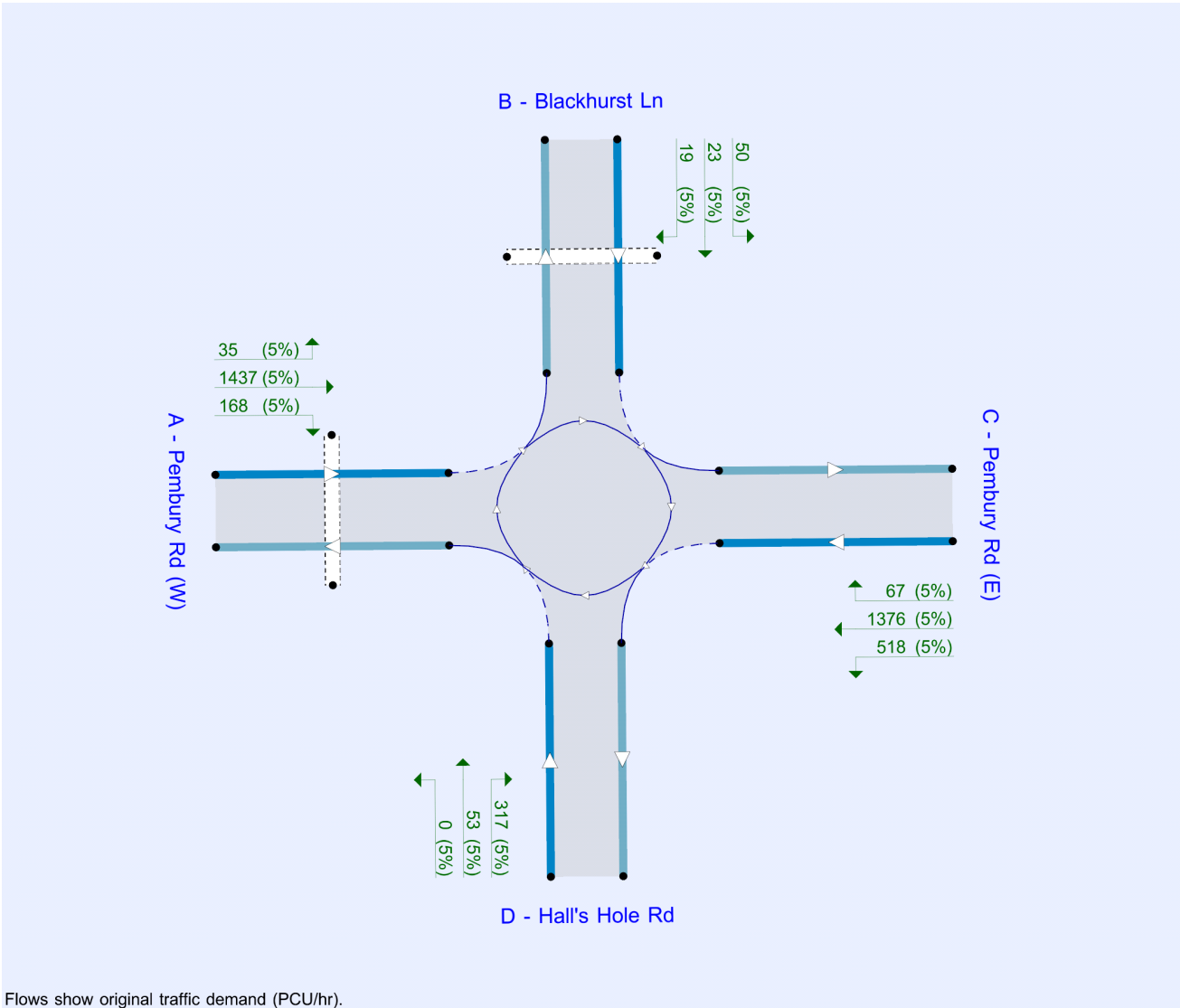

Flows show original traffic demand (PCU/hr).  
The junction diagram reflects the last run of Junctions.

**Analysis Options**

Vehicle length (m)	Calculate Q Percentiles	Calculate detailed queueing delay	Show lane queues in feet / metres	Show all PICADY stream intercepts	Calculate residual capacity	RFC Threshold	Av. Delay threshold (s)	Q threshold (PCU)	Use simulation for HCM roundabouts	Use iterations for HCM roundabouts
5.75						0.85	36.00	20.00		

**Demand Set Summary**

ID	Scenario name	Time Period name	Traffic profile type	Start time (HH:mm)	Finish time (HH:mm)	Time segment length (min)	Run automatically
D1	Option 1 Demand	AM	ONE HOUR	07:15	08:45	15	✓
D2	Option 1 Demand	PM	ONE HOUR	16:30	18:00	15	✓
D3	Option 2 Demand	AM	ONE HOUR	07:15	08:45	15	✓
D4	Option 2 Demand	PM	ONE HOUR	16:30	18:00	15	✓

**Analysis Set Details**

ID	Include in report	Network flow scaling factor (%)	Network capacity scaling factor (%)
A1	✓	100.000	100.000





# Option 1 Demand, AM

## Data Errors and Warnings

Severity	Area	Item	Description
Warning	Geometry	D - Hall's Hole Rd - Roundabout Geometry	Effective flare length is over 30m, which is outside the normal range. Treat capacities with increasing caution.

## Junction Network

### Junctions

Junction	Name	Junction type	Use circulating lanes	Arm order	Junction Delay (s)	Junction LOS
1	untitled	Standard Roundabout		A, B, C, D	456.82	F

### Junction Network

Driving side	Lighting	Network delay (s)	Network LOS
Left	Normal/unknown	456.82	F

## Arms

### Arms

Arm	Name	Description	No give-way line
A	Pembury Rd (W)		
B	Blackhurst Ln		
C	Pembury Rd (E)		
D	Hall's Hole Rd		

### Roundabout Geometry

Arm	V (m)	E (m)	I' (m)	R (m)	D (m)	PHI (deg)	Entry only	Exit only
A - Pembury Rd (W)	4.23	7.00	25.8	11.0	44.0	32.0		
B - Blackhurst Ln	2.87	4.50	18.4	22.0	44.0	28.0		
C - Pembury Rd (E)	3.47	6.93	13.9	20.0	44.0	28.0		
D - Hall's Hole Rd	2.60	4.20	92.7	22.0	44.0	22.0		

### Pelican/Puffin Crossings

Arm	Space between crossing and junc. entry (Signalised) (PCU)	Amber time preceding red (s)	Amber time regarded as green (s)	Time from traffic red start to green man start (s)	Time period green man shown (s)	Clearance Period (s)	Traffic minimum green (s)
A - Pembury Rd (W)	10.00	3.00	2.90	3.00	6.00	9.00	60.00
B - Blackhurst Ln	2.00	3.00	2.90	3.00	6.00	6.00	30.00

### Slope / Intercept / Capacity

#### Roundabout Slope and Intercept used in model

Arm	Final slope	Final intercept (PCU/hr)
A - Pembury Rd (W)	0.640	1816
B - Blackhurst Ln	0.550	1269
C - Pembury Rd (E)	0.622	1644
D - Hall's Hole Rd	0.560	1287

The slope and intercept shown above include any corrections and adjustments.

## Traffic Demand

### Demand Set Details

ID	Scenario name	Time Period name	Traffic profile type	Start time (HH:mm)	Finish time (HH:mm)	Time segment length (min)	Run automatically
D1	Option 1 Demand	AM	ONE HOUR	07:15	08:45	15	✓

### Demand overview (Traffic)

Arm	Linked arm	Profile type	Use O-D data	Av. Demand (PCU/hr)	Scaling Factor (%)
A - Pembury Rd (W)		ONE HOUR	✓	1663	100.000
B - Blackhurst Ln		ONE HOUR	✓	222	100.000
C - Pembury Rd (E)		ONE HOUR	✓	1829	100.000
D - Hall's Hole Rd		ONE HOUR	✓	350	100.000

### Demand overview (Pedestrians)

Arm	Profile type	Av. Ped flow (Ped/hr)
A - Pembury Rd (W)	[ONEHOUR]	120.00
B - Blackhurst Ln	[ONEHOUR]	200.00
C - Pembury Rd (E)		
D - Hall's Hole Rd		

## Origin-Destination Data

### Demand (PCU/hr)

		To			
		A - Pembury Rd (W)	B - Blackhurst Ln	C - Pembury Rd (E)	D - Hall's Hole Rd
From	A - Pembury Rd (W)	0	120	1493	50
	B - Blackhurst Ln	106	0	101	15
	C - Pembury Rd (E)	1428	74	0	327
	D - Hall's Hole Rd	0	13	337	0

## Vehicle Mix

HV data entry mode	PCU Factor for a HV (PCU)
HV Percentages	2.00

### Heavy Vehicle %

		To			
		A - Pembury Rd (W)	B - Blackhurst Ln	C - Pembury Rd (E)	D - Hall's Hole Rd
From	A - Pembury Rd (W)	0	5	5	5
	B - Blackhurst Ln	5	0	5	5
	C - Pembury Rd (E)	5	5	0	5
	D - Hall's Hole Rd	5	5	5	0

## Results

### Results Summary for whole modelled period

Arm	Max RFC	Max Delay (s)	Max Q (PCU)	Max LOS	Av. Demand (PCU/hr)	Total Junction Arrivals (PCU)
A - Pembury Rd (W)	1.20	356.45	163.4	F	1526	2289
B - Blackhurst Ln	0.86	77.63	4.9	F	204	306
C - Pembury Rd (E)	1.31	676.15	301.8	F	1678	2517
D - Hall's Hole Rd	0.74	28.06	2.9	D	321	482



# Option 1 Demand, PM

## Data Errors and Warnings

Severity	Area	Item	Description
Warning	Geometry	D - Hall's Hole Rd - Roundabout Geometry	Effective flare length is over 30m, which is outside the normal range. Treat capacities with increasing caution.

## Junction Network

### Junctions

Junction	Name	Junction type	Use circulating lanes	Arm order	Junction Delay (s)	Junction LOS
1	untitled	Standard Roundabout		A, B, C, D	448.17	F

### Junction Network

Driving side	Lighting	Network delay (s)	Network LOS
Left	Normal/unknown	448.17	F

## Traffic Demand

### Demand Set Details

ID	Scenario name	Time Period name	Traffic profile type	Start time (HH:mm)	Finish time (HH:mm)	Time segment length (min)	Run automatically
D2	Option 1 Demand	PM	ONE HOUR	16:30	18:00	15	✓

### Demand overview (Traffic)

Arm	Linked arm	Profile type	Use O-D data	Av. Demand (PCU/hr)	Scaling Factor (%)
A - Pembury Rd (W)		ONE HOUR	✓	1520	100.000
B - Blackhurst Ln		ONE HOUR	✓	92	100.000
C - Pembury Rd (E)		ONE HOUR	✓	1914	100.000
D - Hall's Hole Rd		ONE HOUR	✓	318	100.000

### Demand overview (Pedestrians)

Arm	Profile type	Av. Ped flow (Ped/hr)
A - Pembury Rd (W)	[ONEHOUR]	120.00
B - Blackhurst Ln	[ONEHOUR]	200.00
C - Pembury Rd (E)		
D - Hall's Hole Rd		

## Origin-Destination Data

### Demand (PCU/hr)

		To			
		A - Pembury Rd (W)	B - Blackhurst Ln	C - Pembury Rd (E)	D - Hall's Hole Rd
From	A - Pembury Rd (W)	0	35	1399	86
	B - Blackhurst Ln	19	0	50	23
	C - Pembury Rd (E)	1317	67	0	530
	D - Hall's Hole Rd	0	53	265	0

## Vehicle Mix

HV data entry mode	PCU Factor for a HV (PCU)
HV Percentages	2.00

### Heavy Vehicle %

		To			
		A - Pembury Rd (W)	B - Blackhurst Ln	C - Pembury Rd (E)	D - Hall's Hole Rd
From	A - Pembury Rd (W)	0	5	5	5
	B - Blackhurst Ln	5	0	5	5
	C - Pembury Rd (E)	5	5	0	5
	D - Hall's Hole Rd	5	5	5	0

## Results

### Results Summary for whole modelled period

Arm	Max RFC	Max Delay (s)	Max Q (PCU)	Max LOS	Av. Demand (PCU/hr)	Total Junction Arrivals (PCU)
A - Pembury Rd (W)	1.07	138.37	71.5	F	1395	2092
B - Blackhurst Ln	0.38	22.91	0.6	C	84	127
C - Pembury Rd (E)	1.35	786.97	361.6	F	1756	2634
D - Hall's Hole Rd	0.54	12.85	1.2	B	292	438

# Option 2 Demand, AM

## Data Errors and Warnings

Severity	Area	Item	Description
Warning	Geometry	D - Hall's Hole Rd - Roundabout Geometry	Effective flare length is over 30m, which is outside the normal range. Treat capacities with increasing caution.

## Junction Network

### Junctions

Junction	Name	Junction type	Use circulating lanes	Arm order	Junction Delay (s)	Junction LOS
1	untitled	Standard Roundabout		A, B, C, D	615.08	F

### Junction Network

Driving side	Lighting	Network delay (s)	Network LOS
Left	Normal/unknown	615.08	F

## Traffic Demand

### Demand Set Details

ID	Scenario name	Time Period name	Traffic profile type	Start time (HH:mm)	Finish time (HH:mm)	Time segment length (min)	Run automatically
D3	Option 2 Demand	AM	ONE HOUR	07:15	08:45	15	✓

### Demand overview (Traffic)

Arm	Linked arm	Profile type	Use O-D data	Av. Demand (PCU/hr)	Scaling Factor (%)
A - Pembury Rd (W)		ONE HOUR	✓	1782	100.000
B - Blackhurst Ln		ONE HOUR	✓	222	100.000
C - Pembury Rd (E)		ONE HOUR	✓	1855	100.000
D - Hall's Hole Rd		ONE HOUR	✓	419	100.000

### Demand overview (Pedestrians)

Arm	Profile type	Av. Ped flow (Ped/hr)
A - Pembury Rd (W)	[ONEHOUR]	120.00
B - Blackhurst Ln	[ONEHOUR]	200.00
C - Pembury Rd (E)		
D - Hall's Hole Rd		

## Origin-Destination Data

### Demand (PCU/hr)

		To			
		A - Pembury Rd (W)	B - Blackhurst Ln	C - Pembury Rd (E)	D - Hall's Hole Rd
From	A - Pembury Rd (W)	0	121	1575	86
	B - Blackhurst Ln	106	0	101	15
	C - Pembury Rd (E)	1457	72	0	326
	D - Hall's Hole Rd	0	14	405	0

## Vehicle Mix

HV data entry mode	PCU Factor for a HV (PCU)
HV Percentages	2.00

### Heavy Vehicle %

		To			
		A - Pembury Rd (W)	B - Blackhurst Ln	C - Pembury Rd (E)	D - Hall's Hole Rd
From	A - Pembury Rd (W)	0	5	5	5
	B - Blackhurst Ln	5	0	5	5
	C - Pembury Rd (E)	5	5	0	5
	D - Hall's Hole Rd	5	5	5	0

## Results

### Results Summary for whole modelled period

Arm	Max RFC	Max Delay (s)	Max Q (PCU)	Max LOS	Av. Demand (PCU/hr)	Total Junction Arrivals (PCU)
A - Pembury Rd (W)	1.32	649.83	286.3	F	1635	2453
B - Blackhurst Ln	0.93	112.67	7.1	F	204	306
C - Pembury Rd (E)	1.34	768.71	343.1	F	1702	2553
D - Hall's Hole Rd	0.88	53.29	6.3	F	384	577

# Option 2 Demand, PM

## Data Errors and Warnings

Severity	Area	Item	Description
Warning	Geometry	D - Hall's Hole Rd - Roundabout Geometry	Effective flare length is over 30m, which is outside the normal range. Treat capacities with increasing caution.

## Junction Network

### Junctions

Junction	Name	Junction type	Use circulating lanes	Arm order	Junction Delay (s)	Junction LOS
1	untitled	Standard Roundabout		A, B, C, D	648.07	F

### Junction Network

Driving side	Lighting	Network delay (s)	Network LOS
Left	Normal/unknown	648.07	F

## Traffic Demand

### Demand Set Details

ID	Scenario name	Time Period name	Traffic profile type	Start time (HH:mm)	Finish time (HH:mm)	Time segment length (min)	Run automatically
D4	Option 2 Demand	PM	ONE HOUR	16:30	18:00	15	✓

### Demand overview (Traffic)

Arm	Linked arm	Profile type	Use O-D data	Av. Demand (PCU/hr)	Scaling Factor (%)
A - Pembury Rd (W)		ONE HOUR	✓	1640	100.000
B - Blackhurst Ln		ONE HOUR	✓	92	100.000
C - Pembury Rd (E)		ONE HOUR	✓	1961	100.000
D - Hall's Hole Rd		ONE HOUR	✓	370	100.000

### Demand overview (Pedestrians)

Arm	Profile type	Av. Ped flow (Ped/hr)
A - Pembury Rd (W)	[ONEHOUR]	120.00
B - Blackhurst Ln	[ONEHOUR]	200.00
C - Pembury Rd (E)		
D - Hall's Hole Rd		

## Origin-Destination Data

### Demand (PCU/hr)

		To			
		A - Pembury Rd (W)	B - Blackhurst Ln	C - Pembury Rd (E)	D - Hall's Hole Rd
From	A - Pembury Rd (W)	0	35	1437	168
	B - Blackhurst Ln	19	0	50	23
	C - Pembury Rd (E)	1376	67	0	518
	D - Hall's Hole Rd	0	53	317	0



## Vehicle Mix

HV data entry mode	PCU Factor for a HV (PCU)
HV Percentages	2.00

### Heavy Vehicle %

		To			
		A - Pembury Rd (W)	B - Blackhurst Ln	C - Pembury Rd (E)	D - Hall's Hole Rd
From	A - Pembury Rd (W)	0	5	5	5
	B - Blackhurst Ln	5	0	5	5
	C - Pembury Rd (E)	5	5	0	5
	D - Hall's Hole Rd	5	5	5	0

## Results

### Results Summary for whole modelled period

Arm	Max RFC	Max Delay (s)	Max Q (PCU)	Max LOS	Av. Demand (PCU/hr)	Total Junction Arrivals (PCU)
A - Pembury Rd (W)	1.19	331.49	154.2	F	1505	2257
B - Blackhurst Ln	0.41	25.03	0.7	D	84	127
C - Pembury Rd (E)	1.42	1061.40	453.5	F	1799	2699
D - Hall's Hole Rd	0.63	15.53	1.7	C	340	509

**Appendix J**  
**Halls Hole Road Junction Improvements Drawing**

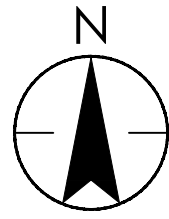

Plotted: --- By: Smith, Daniel  
ORIGINAL SHEET - ISOA3  
J:\332611481 - gh - tunbridge wells local plan\3-autocad\drawings\100\332611481-str-hgn-h-0005 - pembury road junctions mitigation - hall's hole (tbl)

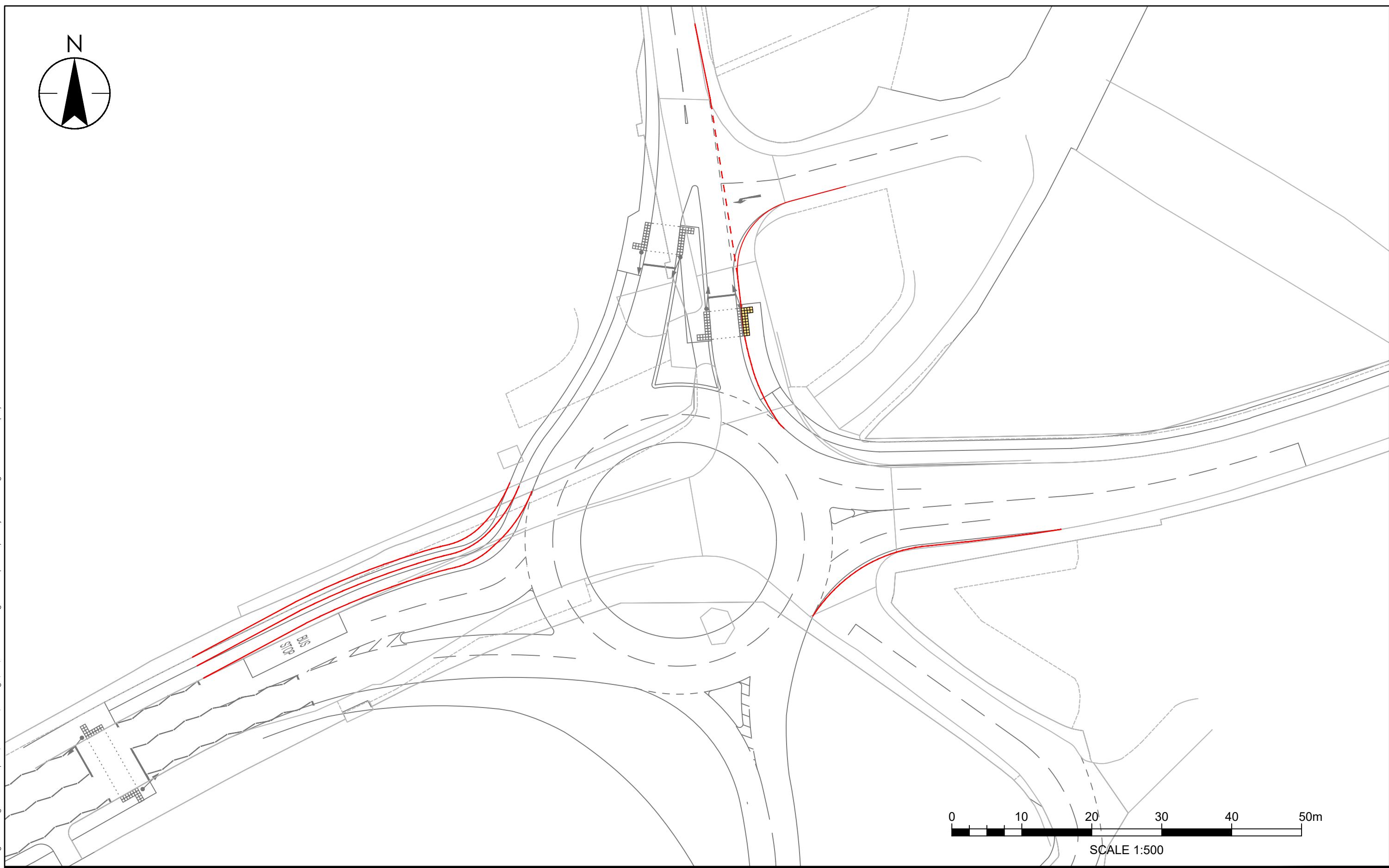

### S2 FOR INFORMATION

Client/Project:  
TWBC  
  
TUNBRIDGE WELLS  
LOCAL PLAN

Project No.:  
332611481

Title  
PEMBURY ROAD POTENTIAL  
MITIGATION SCHEME -  
HALL'S HOLE ROUNDABOUT  
OPTION

Revision:	Date:	Drawing No.
-	2024.05.13	0005

Stantec UK Limited  
Unit 10, Connect 38, 1 Dover Place  
Ashford  
TN23 1FB  
Tel: +44 1233 527 250  
www.stantec.com/uk

**Appendix K**  
**Halls Hole Road Junction Improvements Modelling Results**

Junctions 10
ARCADY 10 - Roundabout Module
Version: 10.1.1.1905 © Copyright TRL Software Limited, 2023
For sales and distribution information, program advice and maintenance, contact TRL Software: +44 (0)1344 379777 software@trl.co.uk trlsoftware.com
The users of this computer program for the solution of an engineering problem are in no way relieved of their responsibility for the correctness of the solution

**Filename:** Halls Hole Rbt Proposed Mitigation - Further Mit.j10  
**Path:** J:\332611481 - GH - Tunbridge Wells Local Plan\BRIEF 100 - Pembury Road\MODELLING\TRANSPORT\03. JUNCTIONS 10  
**Report generation date:** 14/05/2024 11:01:39

»Option 2 Demand, AM  
 »Option 2 Demand, PM

**Summary of junction performance**

	AM						PM					
	Set ID	Q (PCU)	Delay (s)	RFC	LOS	Junction Delay (s)	Set ID	Q (PCU)	Delay (s)	RFC	LOS	Junction Delay (s)
<b>Option 2 Demand</b>												
A - Pembury Rd (W)	D3	153.6	301.20	1.17	F	373.74	D4	63.3	114.40	1.06	F	405.89
B - Blackhurst Ln		9.0	139.23	0.97	F			0.7	27.07	0.42	D	
C - Pembury Rd (E)		245.2	533.76	1.26	F			352.3	740.52	1.34	F	
D - Hall's Hole Rd		11.9	98.08	0.97	F			2.0	18.52	0.67	C	

There are warnings associated with one or more model runs - see the 'Data Errors and Warnings' tables for each Analysis or Demand Set.

Values shown are the highest values encountered over all time segments. Delay is the maximum value of Av. delay per arriving vehicle. Junction LOS and Junction Delay are demand-weighted Av.s.

**File summary**

**File Description**

<b>Title</b>	Halls Hole Rbt With Crossings
<b>Location</b>	Tunbridge Wells
<b>Site number</b>	
<b>Date</b>	11/01/2021
<b>Version</b>	
<b>Status</b>	(new file)
<b>Identifier</b>	
<b>Client</b>	Stantec
<b>Jobnumber</b>	20013
<b>Enumerator</b>	jct\simon.swanston
<b>Description</b>	

**Units**

Distance units	Speed units	Traffic units input	Traffic units results	Flow units	Av. delay units	Total delay units	Rate of delay units
m	kph	PCU	PCU	perHour	s	-Min	perMin

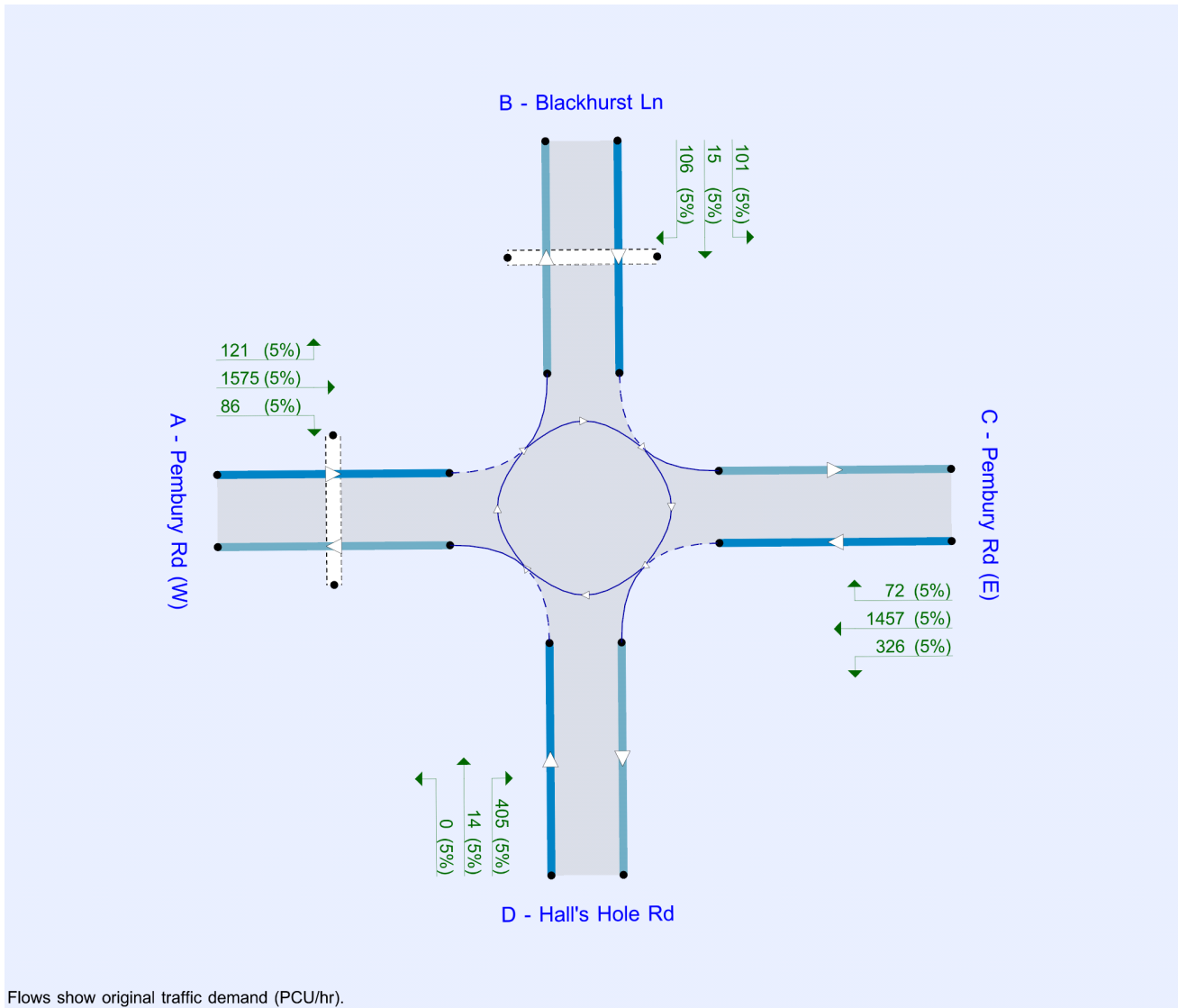

Flows show original traffic demand (PCU/hr).  
The junction diagram reflects the last run of Junctions.

**Analysis Options**

Vehicle length (m)	Calculate Q Percentiles	Calculate detailed queueing delay	Show lane queues in feet / metres	Show all PICADY stream intercepts	Calculate residual capacity	RFC Threshold	Av. Delay threshold (s)	Q threshold (PCU)	Use simulation for HCM roundabouts	Use iterations for HCM roundabouts
5.75						0.85	36.00	20.00		

**Demand Set Summary**

ID	Scenario name	Time Period name	Traffic profile type	Start time (HH:mm)	Finish time (HH:mm)	Time segment length (min)	Run automatically
D1	Option 1 Demand	AM	ONE HOUR	07:15	08:45	15	
D2	Option 1 Demand	PM	ONE HOUR	16:30	18:00	15	
D3	Option 2 Demand	AM	ONE HOUR	07:15	08:45	15	✓
D4	Option 2 Demand	PM	ONE HOUR	16:30	18:00	15	✓

**Analysis Set Details**

ID	Include in report	Network flow scaling factor (%)	Network capacity scaling factor (%)
A1	✓	100.000	100.000

# Option 2 Demand, AM

## Data Errors and Warnings

Severity	Area	Item	Description
Warning	Geometry	D - Hall's Hole Rd - Roundabout Geometry	Effective flare length is over 30m, which is outside the normal range. Treat capacities with increasing caution.

## Junction Network

### Junctions

Junction	Name	Junction type	Use circulating lanes	Arm order	Junction Delay (s)	Junction LOS
1	untitled	Standard Roundabout		A, B, C, D	373.74	F

### Junction Network

Driving side	Lighting	Network delay (s)	Network LOS
Left	Normal/unknown	373.74	F

## Arms

### Arms

Arm	Name	Description	No give-way line
A	Pembury Rd (W)		
B	Blackhurst Ln		
C	Pembury Rd (E)		
D	Hall's Hole Rd		

### Roundabout Geometry

Arm	V (m)	E (m)	I' (m)	R (m)	D (m)	PHI (deg)	Entry only	Exit only
A - Pembury Rd (W)	4.23	8.00	30.0	11.0	44.0	28.0		
B - Blackhurst Ln	2.87	5.20	20.0	22.0	44.0	28.0		
C - Pembury Rd (E)	3.47	7.50	17.0	20.0	44.0	28.0		
D - Hall's Hole Rd	2.60	4.20	92.7	22.0	44.0	22.0		

### Pelican/Puffin Crossings

Arm	Space between crossing and junc. entry (Signalised) (PCU)	Amber time preceding red (s)	Amber time regarded as green (s)	Time from traffic red start to green man start (s)	Time period green man shown (s)	Clearance Period (s)	Traffic minimum green (s)
A - Pembury Rd (W)	10.00	3.00	2.90	3.00	6.00	9.00	60.00
B - Blackhurst Ln	5.00	3.00	2.90	3.00	6.00	6.00	30.00

### Slope / Intercept / Capacity

#### Roundabout Slope and Intercept used in model

Arm	Final slope	Final intercept (PCU/hr)
A - Pembury Rd (W)	0.685	2026
B - Blackhurst Ln	0.575	1399
C - Pembury Rd (E)	0.644	1757
D - Hall's Hole Rd	0.560	1287

The slope and intercept shown above include any corrections and adjustments.

## Traffic Demand

### Demand Set Details

ID	Scenario name	Time Period name	Traffic profile type	Start time (HH:mm)	Finish time (HH:mm)	Time segment length (min)	Run automatically
D3	Option 2 Demand	AM	ONE HOUR	07:15	08:45	15	✓

### Demand overview (Traffic)

Arm	Linked arm	Profile type	Use O-D data	Av. Demand (PCU/hr)	Scaling Factor (%)
A - Pembury Rd (W)		ONE HOUR	✓	1782	100.000
B - Blackhurst Ln		ONE HOUR	✓	222	100.000
C - Pembury Rd (E)		ONE HOUR	✓	1855	100.000
D - Hall's Hole Rd		ONE HOUR	✓	419	100.000

### Demand overview (Pedestrians)

Arm	Profile type	Av. Ped flow (Ped/hr)
A - Pembury Rd (W)	[ONEHOUR]	120.00
B - Blackhurst Ln	[ONEHOUR]	200.00
C - Pembury Rd (E)		
D - Hall's Hole Rd		

## Origin-Destination Data

### Demand (PCU/hr)

		To			
		A - Pembury Rd (W)	B - Blackhurst Ln	C - Pembury Rd (E)	D - Hall's Hole Rd
From	A - Pembury Rd (W)	0	121	1575	86
	B - Blackhurst Ln	106	0	101	15
	C - Pembury Rd (E)	1457	72	0	326
	D - Hall's Hole Rd	0	14	405	0

## Vehicle Mix

HV data entry mode	PCU Factor for a HV (PCU)
HV Percentages	2.00

### Heavy Vehicle %

		To			
		A - Pembury Rd (W)	B - Blackhurst Ln	C - Pembury Rd (E)	D - Hall's Hole Rd
From	A - Pembury Rd (W)	0	5	5	5
	B - Blackhurst Ln	5	0	5	5
	C - Pembury Rd (E)	5	5	0	5
	D - Hall's Hole Rd	5	5	5	0

## Results

### Results Summary for whole modelled period

Arm	Max RFC	Max Delay (s)	Max Q (PCU)	Max LOS	Av. Demand (PCU/hr)	Total Junction Arrivals (PCU)
A - Pembury Rd (W)	1.17	301.20	153.6	F	1635	2453
B - Blackhurst Ln	0.97	139.23	9.0	F	204	306
C - Pembury Rd (E)	1.26	533.76	245.2	F	1702	2553
D - Hall's Hole Rd	0.97	98.08	11.9	F	384	577





# Option 2 Demand, PM

## Data Errors and Warnings

Severity	Area	Item	Description
Warning	Geometry	D - Hall's Hole Rd - Roundabout Geometry	Effective flare length is over 30m, which is outside the normal range. Treat capacities with increasing caution.

## Junction Network

### Junctions

Junction	Name	Junction type	Use circulating lanes	Arm order	Junction Delay (s)	Junction LOS
1	untitled	Standard Roundabout		A, B, C, D	405.89	F

### Junction Network

Driving side	Lighting	Network delay (s)	Network LOS
Left	Normal/unknown	405.89	F

## Traffic Demand

### Demand Set Details

ID	Scenario name	Time Period name	Traffic profile type	Start time (HH:mm)	Finish time (HH:mm)	Time segment length (min)	Run automatically
D4	Option 2 Demand	PM	ONE HOUR	16:30	18:00	15	✓

### Demand overview (Traffic)

Arm	Linked arm	Profile type	Use O-D data	Av. Demand (PCU/hr)	Scaling Factor (%)
A - Pembury Rd (W)		ONE HOUR	✓	1640	100.000
B - Blackhurst Ln		ONE HOUR	✓	92	100.000
C - Pembury Rd (E)		ONE HOUR	✓	1961	100.000
D - Hall's Hole Rd		ONE HOUR	✓	370	100.000

### Demand overview (Pedestrians)

Arm	Profile type	Av. Ped flow (Ped/hr)
A - Pembury Rd (W)	[ONEHOUR]	120.00
B - Blackhurst Ln	[ONEHOUR]	200.00
C - Pembury Rd (E)		
D - Hall's Hole Rd		

## Origin-Destination Data

### Demand (PCU/hr)

		To			
		A - Pembury Rd (W)	B - Blackhurst Ln	C - Pembury Rd (E)	D - Hall's Hole Rd
From	A - Pembury Rd (W)	0	35	1437	168
	B - Blackhurst Ln	19	0	50	23
	C - Pembury Rd (E)	1376	67	0	518
	D - Hall's Hole Rd	0	53	317	0

## Vehicle Mix

HV data entry mode	PCU Factor for a HV (PCU)
HV Percentages	2.00

### Heavy Vehicle %

		To			
		A - Pembury Rd (W)	B - Blackhurst Ln	C - Pembury Rd (E)	D - Hall's Hole Rd
From	A - Pembury Rd (W)	0	5	5	5
	B - Blackhurst Ln	5	0	5	5
	C - Pembury Rd (E)	5	5	0	5
	D - Hall's Hole Rd	5	5	5	0

## Results

### Results Summary for whole modelled period

Arm	Max RFC	Max Delay (s)	Max Q (PCU)	Max LOS	Av. Demand (PCU/hr)	Total Junction Arrivals (PCU)
A - Pembury Rd (W)	1.06	114.40	63.3	F	1505	2257
B - Blackhurst Ln	0.42	27.07	0.7	D	84	127
C - Pembury Rd (E)	1.34	740.52	352.3	F	1799	2699
D - Hall's Hole Rd	0.67	18.52	2.0	C	340	509

**Appendix L**  
**Halls Hole Road Junction Sensitivity Test Drawing**

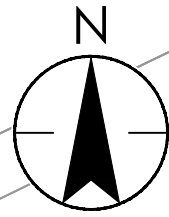

Plotted: 27.06.2024 06:27 8:25:54 AM By: Smith, Daniel  
ORIGINAL SHEET - ISOA3  
J:\332611481 - gh - tunbridge wells local plan\3-autocad\drawings\100\332611481-str-hgn-h-0006 - pembury road junctions mitigation - hall's hole (signals)

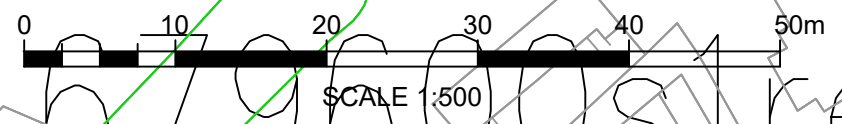
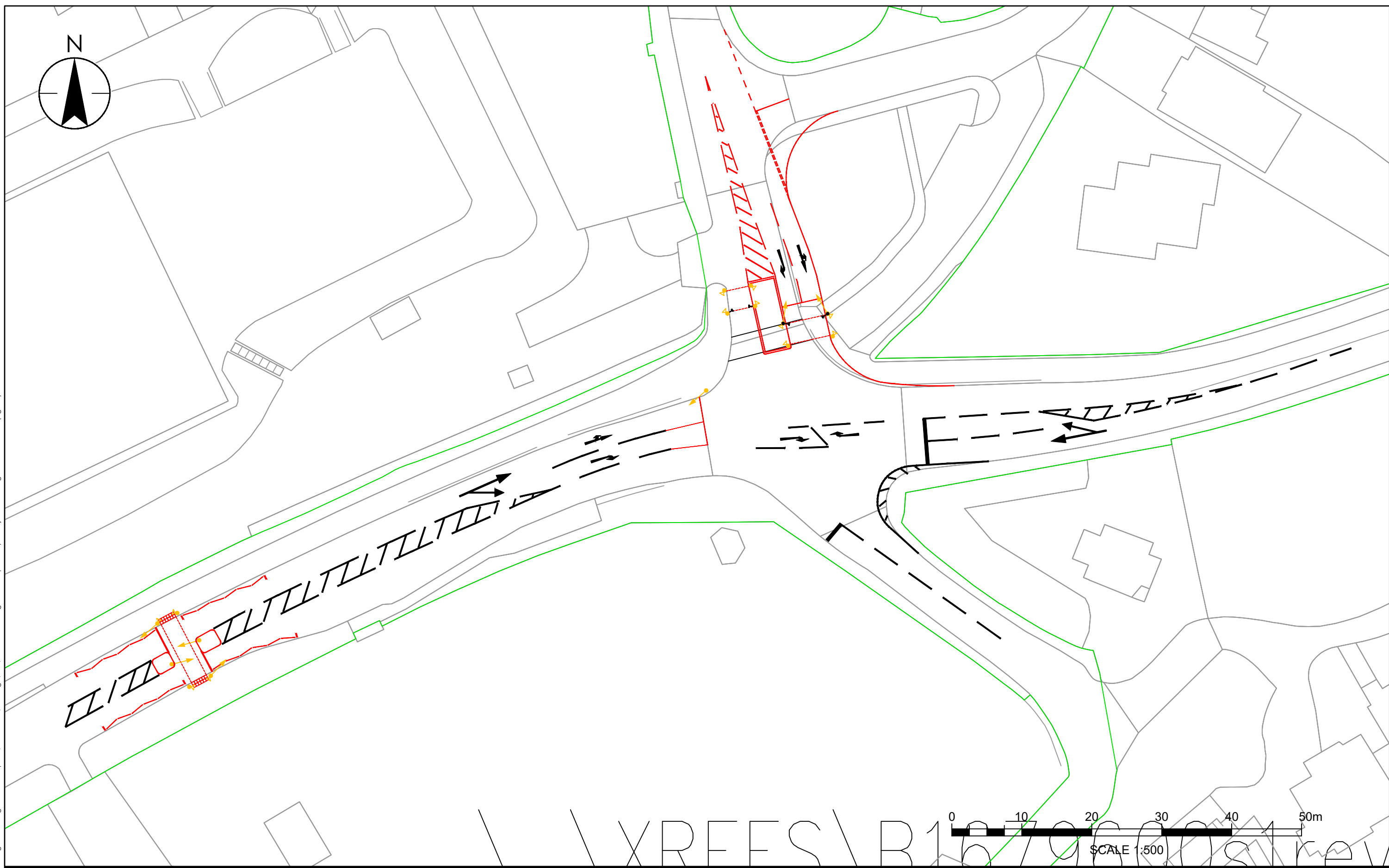

**Stantec**  
Stantec UK Limited  
Unit 10, Connect 38, 1 Dover Place  
Ashford  
TN23 1FB  
Tel. +44 1233 527 250  
www.stantec.com/uk

**S2 FOR INFORMATION**

Client/Project:  
TWBC  
  
TUNBRIDGE WELLS  
LOCAL PLAN  
  
Project No.:  
332611481

Title  
PEMBURY ROAD POTENTIAL  
MITIGATION SCHEME -  
HALL'S HOLE SIGNAL  
OPTION  
  
Revision: - Date: 2024.05.13 Drawing No. 0006

**Appendix M**  
**Halls Hole Road Junction Sensitivity Test Modelling Results**

Full Input Data And Results  
Full Input Data And Results

User and Project Details

Project:	
Title:	
Location:	
Additional detail:	
File name:	Halls Hole Road Signal Junction (Mitigation Layout).lsg3x
Author:	
Company:	
Address:	

Network Layout Diagram

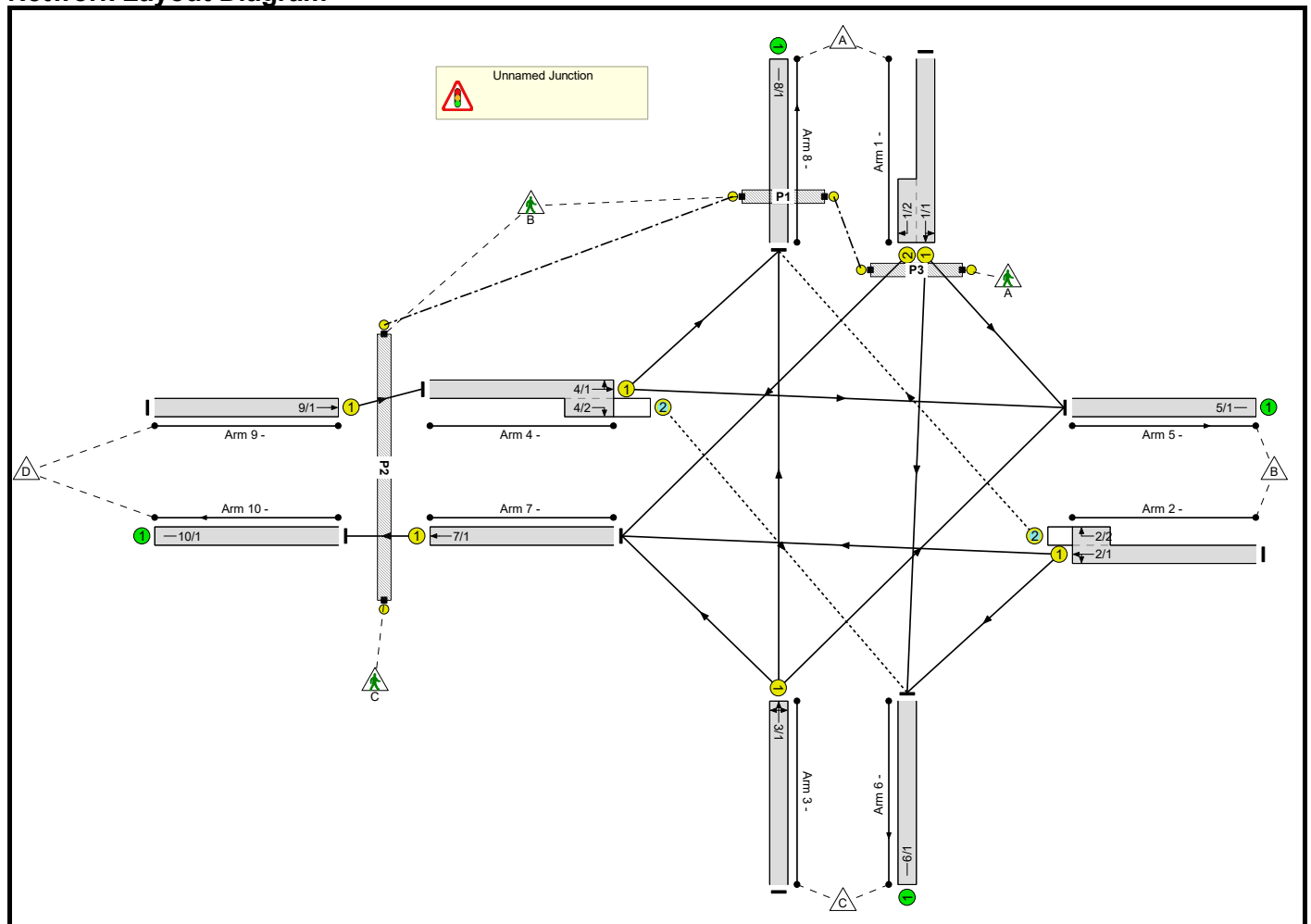

**Phase Diagram**

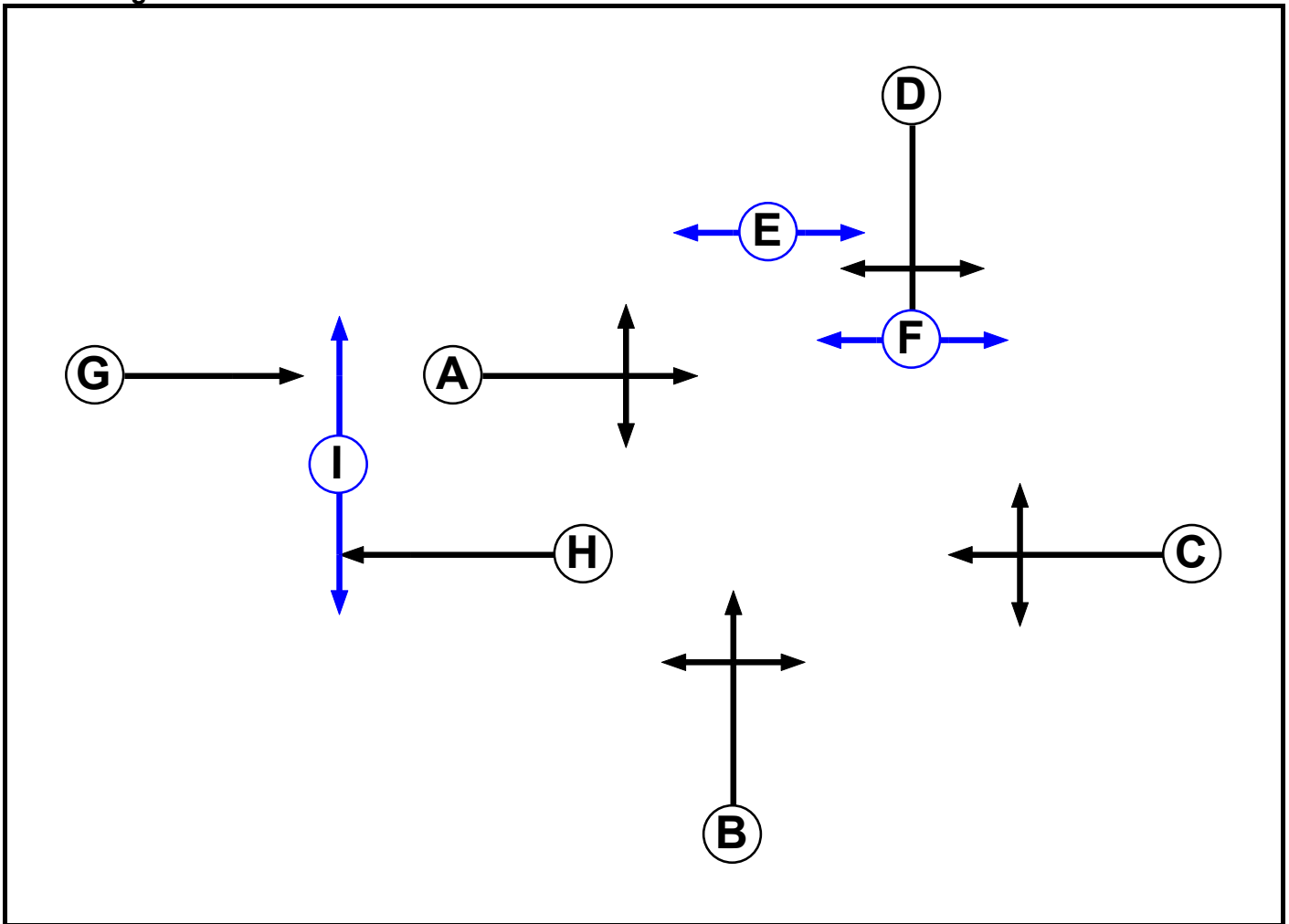

**Phase Input Data**

Phase Name	Phase Type	Stage Stream	Assoc. Phase	Street Min	Cont Min
A	Traffic	1		7	7
B	Traffic	1		7	7
C	Traffic	1		7	7
D	Traffic	1		7	7
E	Pedestrian	1		6	6
F	Pedestrian	1		6	6
G	Traffic	2		7	7
H	Traffic	2		7	7
I	Pedestrian	2		6	6



**Phase Intergrens Matrix**

		Starting Phase								
		A	B	C	D	E	F	G	H	I
Terminating Phase	A		6	-	7	7	-	-	-	-
	B	6		5	7	8	-	-	-	-
	C	-	6		6	8	-	-	-	-
	D	6	7	6		-	5	-	-	-
	E	8	8	8	-		-	-	-	-
	F	-	-	-	7	-		-	-	-
	G	-	-	-	-	-	-		-	5
	H	-	-	-	-	-	-	-		5
	I	-	-	-	-	-	-	10	10	

**Phases in Stage**

Stream	Stage No.	Phases in Stage
1	1	A C F
1	2	B F
1	3	D E
2	1	G H
2	2	I

**Stage Diagram**

**Stage Stream: 1**

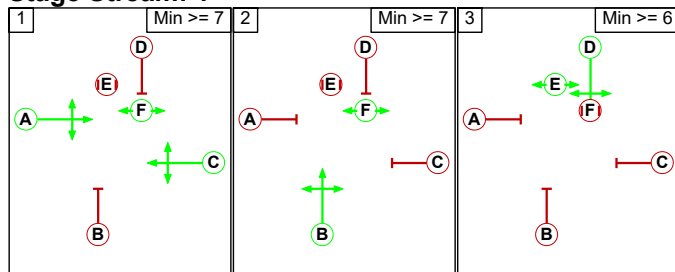

**Stage Stream: 2**

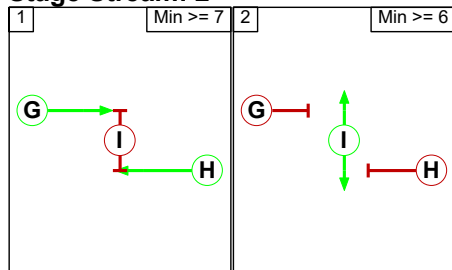

**Phase Delays**

**Stage Stream: 1**

Term. Stage	Start Stage	Phase	Type	Value	Cont value
There are no Phase Delays defined					

Full Input Data And Results

**Stage Stream: 2**

Term. Stage	Start Stage	Phase	Type	Value	Cont value
There are no Phase Delays defined					

**Prohibited Stage Change**

**Stage Stream: 1**

		To Stage		
		1	2	3
From Stage	1		6	8
	2	6		8
	3	8	8	

**Stage Stream: 2**

		To Stage	
		1	2
From Stage	1		5
	2	10	

Full Input Data And Results

**Give-Way Lane Input Data**

Junction: Unnamed Junction											
Lane	Movement	Max Flow when Giving Way (PCU/Hr)	Min Flow when Giving Way (PCU/Hr)	Opposing Lane	Opp. Lane Coeff.	Opp. Mvmnts.	Right Turn Storage (PCU)	Non-Blocking Storage (PCU)	RTF	Right Turn Move up (s)	Max Turns in Intergreen (PCU)
2/2	8/1 (Right)	1439	0	4/1	1.09	All	2.00	-	0.50	2	2.00
4/2	6/1 (Right)	1439	0	2/1	1.09	All	3.00	-	0.50	3	3.00

Full Input Data And Results

**Lane Input Data**

Junction: Unnamed Junction												
Lane	Lane Type	Phases	Start Disp.	End Disp.	Physical Length (PCU)	Sat Flow Type	Def User Saturation Flow (PCU/Hr)	Lane Width (m)	Gradient	Nearside Lane	Turns	Turning Radius (m)
1/1	U	D	2	3	60.0	Geom	-	2.68	0.00	Y	Arm 5 Left	14.80
											Arm 6 Ahead	Inf
1/2	U	D	2	3	5.2	Geom	-	2.83	0.00	Y	Arm 7 Right	14.90
2/1	U	C	2	3	60.0	Geom	-	3.42	0.00	Y	Arm 6 Left	Inf
											Arm 7 Ahead	Inf
2/2	O	C	2	3	3.1	Geom	-	3.23	0.00	Y	Arm 8 Right	13.20
3/1	U	B	2	3	60.0	Geom	-	3.10	0.00	Y	Arm 5 Right	9.00
											Arm 7 Left	19.00
											Arm 8 Ahead	Inf
4/1	U	A	2	3	20.9	Geom	-	3.12	0.00	Y	Arm 5 Ahead	Inf
4/2	O	A	2	3	4.0	Geom	-	2.80	0.00	Y	Arm 8 Left	8.30
											Arm 6 Right	9.40
5/1	U		2	3	60.0	Inf	-	-	-	-	-	-
6/1	U		2	3	60.0	Inf	-	-	-	-	-	-
7/1	U	H	2	3	7.0	Geom	-	3.50	0.00	Y	Arm 10 Ahead	Inf
8/1	U		2	3	60.0	Inf	-	-	-	-	-	-
9/1	U	G	2	3	60.0	Geom	-	4.00	0.00	Y	Arm 4 Ahead	Inf
10/1	U		2	3	60.0	Inf	-	-	-	-	-	-

**Traffic Flow Groups**

Flow Group	Start Time	End Time	Duration	Formula
1: 'Option 1 AM Demand'	07:30	08:30	01:00	
2: 'Option 1 PM Demand'	16:45	17:45	01:00	
3: 'Option 2 AM Demand'	07:30	08:30	01:00	
4: 'Option 2 PM Demand'	16:45	17:45	01:00	

**Scenario 1: 'Option 1 AM Demand'** (FG1: 'Option 1 AM Demand', Plan 1: 'Network Control Plan 1')

**Traffic Flows, Desired**

**Desired Flow :**

	Destination					
		A	B	C	D	Tot.
Origin	A	0	101	15	106	222
	B	74	0	327	1428	1829
	C	13	337	0	0	350
	D	120	1493	50	0	1663
	Tot.	207	1931	392	1534	4064

## Full Input Data And Results

### Traffic Lane Flows

Lane	Scenario 1: Option 1 AM Demand
<b>Junction: Unnamed Junction</b>	
1/1 (with short)	222(In) 116(Out)
1/2 (short)	106
2/1 (with short)	1829(In) 1755(Out)
2/2 (short)	74
3/1	350
4/1 (with short)	1663(In) 1613(Out)
4/2 (short)	50
5/1	1931
6/1	392
7/1	1534
8/1	207
9/1	1663
10/1	1534

Full Input Data And Results

**Lane Saturation Flows**

Junction: Unnamed Junction								
Lane	Lane Width (m)	Gradient	Nearside Lane	Allowed Turns	Turning Radius (m)	Turning Prop.	Sat Flow (PCU/Hr)	Flared Sat Flow (PCU/Hr)
1/1	2.68	0.00	Y	Arm 5 Left	14.80	87.1 %	1730	1730
				Arm 6 Ahead	Inf	12.9 %		
1/2	2.83	0.00	Y	Arm 7 Right	14.90	100.0 %	1724	1724
2/1	3.42	0.00	Y	Arm 6 Left	Inf	18.6 %	1957	1957
				Arm 7 Ahead	Inf	81.4 %		
2/2	3.23	0.00	Y	Arm 8 Right	13.20	100.0 %	1740	1740
3/1	3.10	0.00	Y	Arm 5 Right	9.00	96.3 %	1659	1659
				Arm 7 Left	19.00	0.0 %		
				Arm 8 Ahead	Inf	3.7 %		
4/1	3.12	0.00	Y	Arm 5 Ahead	Inf	92.6 %	1901	1901
4/2	2.80	0.00	Y	Arm 8 Left	8.30	7.4 %	1634	1634
				Arm 6 Right	9.40	100.0 %		
5/1	Infinite Saturation Flow						Inf	Inf
6/1	Infinite Saturation Flow						Inf	Inf
7/1	3.50	0.00	Y	Arm 10 Ahead	Inf	100.0 %	1965	1965
8/1	Infinite Saturation Flow						Inf	Inf
9/1	4.00	0.00	Y	Arm 4 Ahead	Inf	100.0 %	2015	2015
10/1	Infinite Saturation Flow						Inf	Inf

**Scenario 2: 'Option 1 PM Demand'** (FG2: 'Option 1 PM Demand', Plan 1: 'Network Control Plan 1')

**Traffic Flows, Desired**

**Desired Flow :**

Origin	Destination					
	A	B	C	D	Tot.	
A	0	50	23	19	92	
B	67	0	530	1317	1914	
C	53	265	0	0	318	
D	35	1399	86	0	1520	
Tot.	155	1714	639	1336	3844	

## Full Input Data And Results

### Traffic Lane Flows

Lane	Scenario 2: Option 1 PM Demand
<b>Junction: Unnamed Junction</b>	
1/1 (with short)	92(In) 73(Out)
1/2 (short)	19
2/1 (with short)	1914(In) 1847(Out)
2/2 (short)	67
3/1	318
4/1 (with short)	1520(In) 1434(Out)
4/2 (short)	86
5/1	1714
6/1	639
7/1	1336
8/1	155
9/1	1520
10/1	1336

Full Input Data And Results

**Lane Saturation Flows**

Junction: Unnamed Junction								
Lane	Lane Width (m)	Gradient	Nearside Lane	Allowed Turns	Turning Radius (m)	Turning Prop.	Sat Flow (PCU/Hr)	Flared Sat Flow (PCU/Hr)
1/1	2.68	0.00	Y	Arm 5 Left	14.80	68.5 %	1761	1761
				Arm 6 Ahead	Inf	31.5 %		
1/2	2.83	0.00	Y	Arm 7 Right	14.90	100.0 %	1724	1724
2/1	3.42	0.00	Y	Arm 6 Left	Inf	28.7 %	1957	1957
				Arm 7 Ahead	Inf	71.3 %		
2/2	3.23	0.00	Y	Arm 8 Right	13.20	100.0 %	1740	1740
3/1	3.10	0.00	Y	Arm 5 Right	9.00	83.3 %	1690	1690
				Arm 7 Left	19.00	0.0 %		
				Arm 8 Ahead	Inf	16.7 %		
4/1	3.12	0.00	Y	Arm 5 Ahead	Inf	97.6 %	1919	1919
4/2	2.80	0.00	Y	Arm 8 Left	8.30	2.4 %	1634	1634
				Arm 6 Right	9.40	100.0 %		
5/1	Infinite Saturation Flow						Inf	Inf
6/1	Infinite Saturation Flow						Inf	Inf
7/1	3.50	0.00	Y	Arm 10 Ahead	Inf	100.0 %	1965	1965
8/1	Infinite Saturation Flow						Inf	Inf
9/1	4.00	0.00	Y	Arm 4 Ahead	Inf	100.0 %	2015	2015
10/1	Infinite Saturation Flow						Inf	Inf

**Scenario 3: 'Option 2 AM Demand'** (FG3: 'Option 2 AM Demand', Plan 1: 'Network Control Plan 1')

**Traffic Flows, Desired**

**Desired Flow :**

Origin	Destination					
	A	B	C	D	Tot.	
A	0	101	15	106	222	
B	72	0	326	1457	1855	
C	14	405	0	0	419	
D	121	1575	86	0	1782	
Tot.	207	2081	427	1563	4278	



## Full Input Data And Results

### Traffic Lane Flows

Lane	Scenario 3: Option 2 AM Demand
<b>Junction: Unnamed Junction</b>	
1/1 (with short)	222(In) 116(Out)
1/2 (short)	106
2/1 (with short)	1855(In) 1783(Out)
2/2 (short)	72
3/1	419
4/1 (with short)	1782(In) 1696(Out)
4/2 (short)	86
5/1	2081
6/1	427
7/1	1563
8/1	207
9/1	1782
10/1	1563

Full Input Data And Results

**Lane Saturation Flows**

Junction: Unnamed Junction								
Lane	Lane Width (m)	Gradient	Nearside Lane	Allowed Turns	Turning Radius (m)	Turning Prop.	Sat Flow (PCU/Hr)	Flared Sat Flow (PCU/Hr)
1/1	2.68	0.00	Y	Arm 5 Left	14.80	87.1 %	1730	1730
				Arm 6 Ahead	Inf	12.9 %		
1/2	2.83	0.00	Y	Arm 7 Right	14.90	100.0 %	1724	1724
2/1	3.42	0.00	Y	Arm 6 Left	Inf	18.3 %	1957	1957
				Arm 7 Ahead	Inf	81.7 %		
2/2	3.23	0.00	Y	Arm 8 Right	13.20	100.0 %	1740	1740
3/1	3.10	0.00	Y	Arm 5 Right	9.00	96.7 %	1658	1658
				Arm 7 Left	19.00	0.0 %		
				Arm 8 Ahead	Inf	3.3 %		
4/1	3.12	0.00	Y	Arm 5 Ahead	Inf	92.9 %	1902	1902
4/2	2.80	0.00	Y	Arm 8 Left	8.30	7.1 %	1634	1634
				Arm 6 Right	9.40	100.0 %		
5/1	Infinite Saturation Flow						Inf	Inf
6/1	Infinite Saturation Flow						Inf	Inf
7/1	3.50	0.00	Y	Arm 10 Ahead	Inf	100.0 %	1965	1965
8/1	Infinite Saturation Flow						Inf	Inf
9/1	4.00	0.00	Y	Arm 4 Ahead	Inf	100.0 %	2015	2015
10/1	Infinite Saturation Flow						Inf	Inf

**Scenario 4: 'Option 2 PM Demand'** (FG4: 'Option 2 PM Demand', Plan 1: 'Network Control Plan 1')

**Traffic Flows, Desired**

**Desired Flow :**

	Destination					
	A	B	C	D	Tot.	
Origin	A	0	50	23	19	92
	B	67	0	518	1376	1961
	C	53	317	0	0	370
	D	35	1437	168	0	1640
	Tot.	155	1804	709	1395	4063

## Full Input Data And Results

### Traffic Lane Flows

Lane	Scenario 4: Option 2 PM Demand
<b>Junction: Unnamed Junction</b>	
1/1 (with short)	92(In) 73(Out)
1/2 (short)	19
2/1 (with short)	1961(In) 1894(Out)
2/2 (short)	67
3/1	370
4/1 (with short)	1640(In) 1472(Out)
4/2 (short)	168
5/1	1804
6/1	709
7/1	1395
8/1	155
9/1	1640
10/1	1395

**Lane Saturation Flows**

Junction: Unnamed Junction								
Lane	Lane Width (m)	Gradient	Nearside Lane	Allowed Turns	Turning Radius (m)	Turning Prop.	Sat Flow (PCU/Hr)	Flared Sat Flow (PCU/Hr)
1/1	2.68	0.00	Y	Arm 5 Left	14.80	68.5 %	1761	1761
				Arm 6 Ahead	Inf	31.5 %		
1/2	2.83	0.00	Y	Arm 7 Right	14.90	100.0 %	1724	1724
2/1	3.42	0.00	Y	Arm 6 Left	Inf	27.3 %	1957	1957
				Arm 7 Ahead	Inf	72.7 %		
2/2	3.23	0.00	Y	Arm 8 Right	13.20	100.0 %	1740	1740
3/1	3.10	0.00	Y	Arm 5 Right	9.00	85.7 %	1684	1684
				Arm 7 Left	19.00	0.0 %		
4/1	3.12	0.00	Y	Arm 8 Ahead	Inf	14.3 %	1919	1919
				Arm 5 Ahead	Inf	97.6 %		
4/2	2.80	0.00	Y	Arm 8 Left	8.30	2.4 %	1634	1634
				Arm 6 Right	9.40	100.0 %		
5/1	Infinite Saturation Flow						Inf	Inf
6/1	Infinite Saturation Flow						Inf	Inf
7/1	3.50	0.00	Y	Arm 10 Ahead	Inf	100.0 %	1965	1965
8/1	Infinite Saturation Flow						Inf	Inf
9/1	4.00	0.00	Y	Arm 4 Ahead	Inf	100.0 %	2015	2015
10/1	Infinite Saturation Flow						Inf	Inf

Scenario 1: 'Option 1 AM Demand' (FG1: 'Option 1 AM Demand', Plan 1: 'Network Control Plan 1')

**Stage Sequence Diagram**

**Stage Stream: 1**

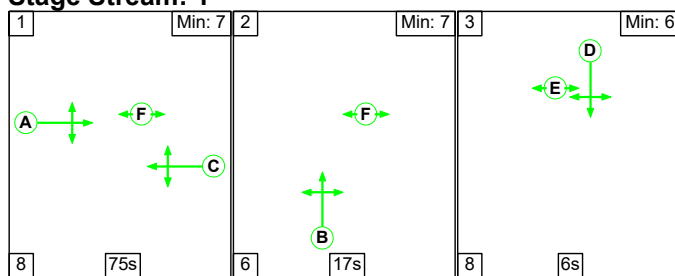

**Stage Stream: 2**

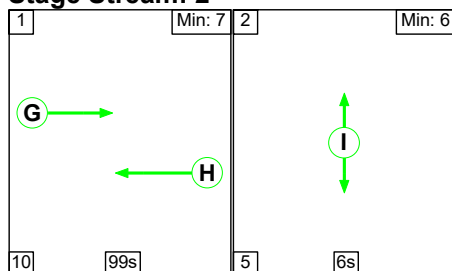

Full Input Data And Results

**Stage Timings**

**Stage Stream: 1**

Stage	1	2	3
Duration	75	17	6
Change Point	0	83	106

**Stage Stream: 2**

Stage	1	2
Duration	99	6
Change Point	109	98

**Signal Timings Diagram**

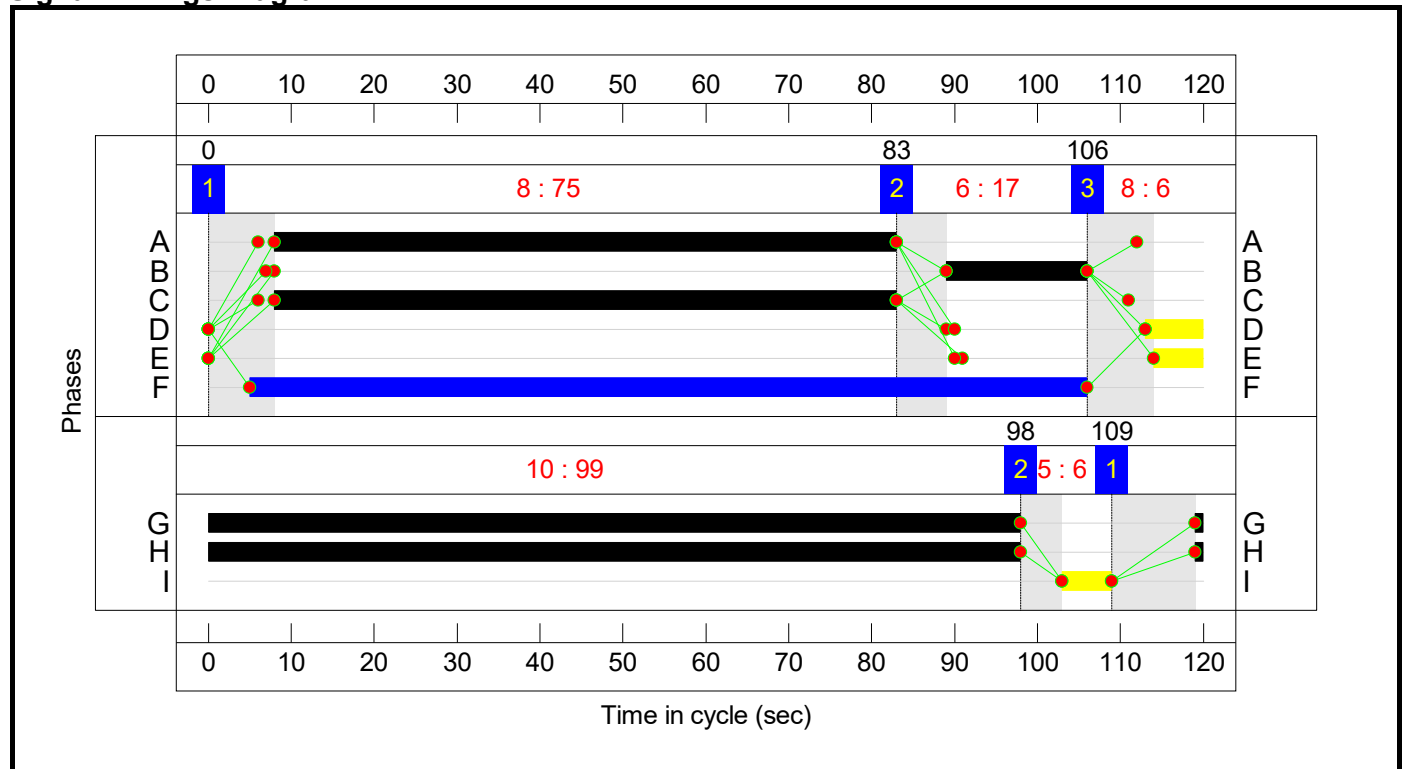

Full Input Data And Results  
**Network Layout Diagram**

Full Input Data And Results

**Unnamed Junction**  
 PRC: -65.1 %  
 Total Traffic Delay: 711.1 pcuHr  
 Ave. Route Delay Per Ped: 0.0 s/Ped

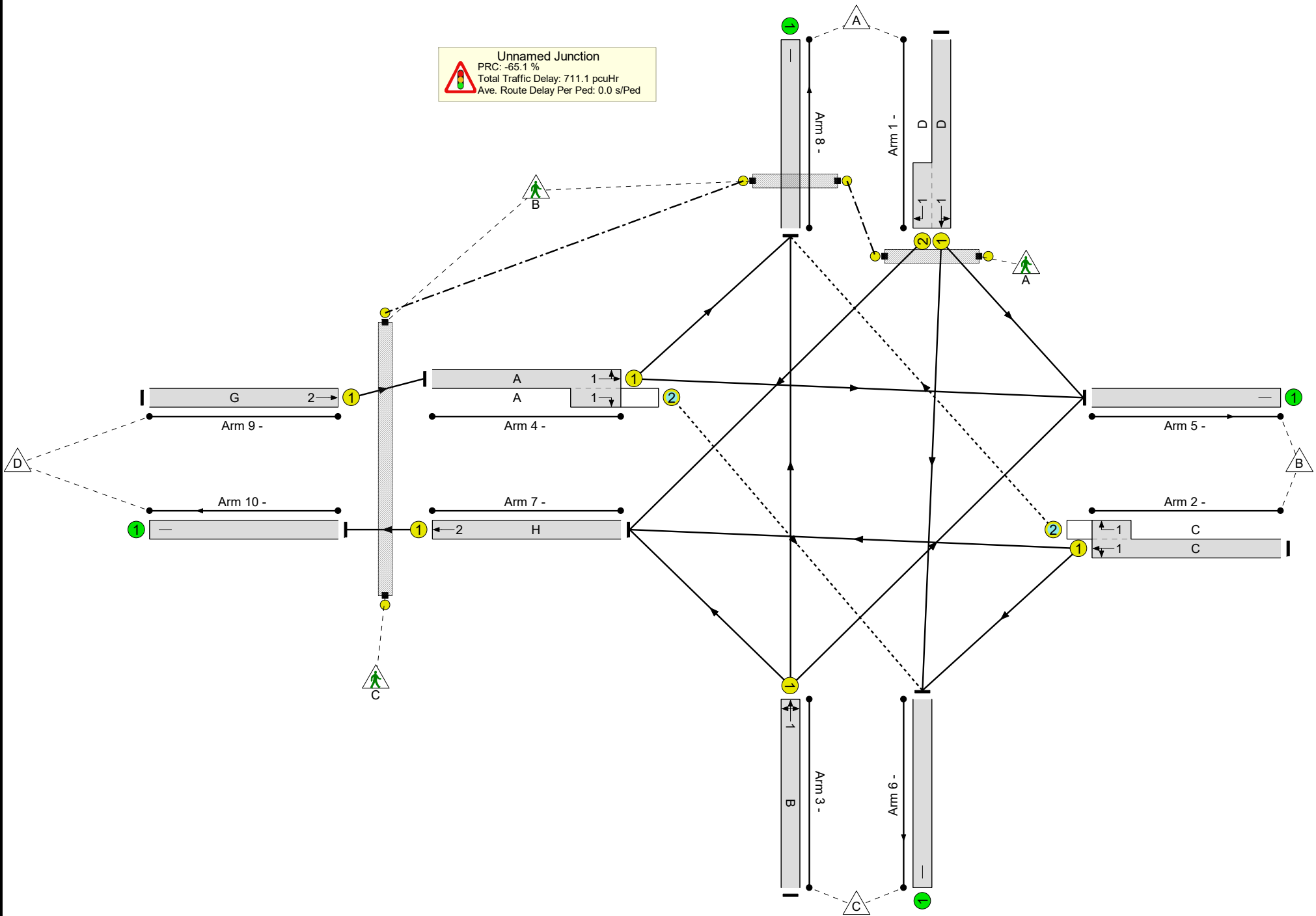

Full Input Data And Results

**Network Results**

Item	Lane Description	Lane Type	Controller Stream	Position In Filtered Route	Full Phase	Arrow Phase	Num Greens	Total Green (s)	Arrow Green (s)	Demand Flow (pcu)	Sat Flow (pcu/Hr)	Capacity (pcu)	Deg Sat (%)
Network	-	-	N/A	-	-		-	-	-	-	-	-	148.6%
Unnamed Junction	-	-	N/A	-	-		-	-	-	-	-	-	148.6%
1/1+1/2	Left Ahead Right	U	1	N/A	D		1	7	-	222	1730:1724	115+115	100.6 : 92.2%
2/1+2/2	Left Ahead Right	U+O	1	N/A	C		1	75	-	1829	1957:1740	1181+50	148.6 : 148.6%
3/1	Right Left Ahead	U	1	N/A	B		1	17	-	350	1659	249	140.6%
4/1+4/2	Ahead Right Left	U+O	1	N/A	A		1	75	-	1663	1901:1634	1160+36	139.1 : 139.1%
5/1		U	N/A	N/A	-		-	-	-	1931	Inf	Inf	0.0%
6/1		U	N/A	N/A	-		-	-	-	392	Inf	Inf	0.0%
7/1	Ahead	U	2	N/A	H		1	99	-	1534	1965	1637	65.2%
8/1		U	N/A	N/A	-		-	-	-	207	Inf	Inf	0.0%
9/1	Ahead	U	2	N/A	G		1	99	-	1663	2015	1679	99.0%
10/1		U	N/A	N/A	-		-	-	-	1534	Inf	Inf	0.0%
Ped Link: P1	Unnamed Ped Link	-	1	-	E		1	6	-	0	-	3600	0.0%
Ped Link: P2	Unnamed Ped Link	-	2	-	I		1	6	-	0	-	3600	0.0%
Ped Link: P3	Unnamed Ped Link	-	1	-	F		1	101	-	0	-	60600	0.0%



Full Input Data And Results

Item	Arriving (pcu)	Leaving (pcu)	Turners In Gaps (pcu)	Turners When Unopposed (pcu)	Turners In Intergreen (pcu)	Uniform Delay (pcuHr)	Rand + Oversat Delay (pcuHr)	Storage Area Uniform Delay (pcuHr)	Total Delay (pcuHr)	Av. Delay Per PCU (s/pcu)	Max. Back of Uniform Queue (pcu)	Rand + Oversat Queue (pcu)	Mean Max Queue (pcu)
Network	-	-	2	0	84	98.5	611.8	0.9	711.1	-	-	-	-
Unnamed Junction	-	-	2	0	84	98.5	611.8	0.9	711.1	-	-	-	-
1/1+1/2	222	221	-	-	-	3.5	6.0	-	9.5	153.5	3.9	6.0	9.9
2/1+2/2	1829	1231	2	0	48	44.3	300.4	0.5	345.2	679.5	83.4	300.4	383.8
3/1	350	249	-	-	-	11.2	52.2	-	63.5	652.7	17.3	52.2	69.6
4/1+4/2	1663	1196	0	0	36	35.0	235.4	0.4	270.8	586.3	75.5	235.4	311.0
5/1	1413	1413	-	-	-	0.0	0.0	-	0.0	0.0	0.0	0.0	0.0
6/1	271	271	-	-	-	0.0	0.0	-	0.0	0.0	0.0	0.0	0.0
7/1	1067	1067	-	-	-	0.1	0.9	-	1.0	3.4	3.5	0.9	4.4
8/1	145	145	-	-	-	0.0	0.0	-	0.0	0.0	0.0	0.0	0.0
9/1	1663	1663	-	-	-	4.4	16.7	-	21.2	45.8	52.7	16.7	69.4
10/1	1067	1067	-	-	-	0.0	0.0	-	0.0	0.0	0.0	0.0	0.0
Ped Link: P1	0	0	-	-	-	-	-	-	0.0	0.0	-	-	0.0
Ped Link: P2	0	0	-	-	-	-	-	-	0.0	0.0	-	-	0.0
Ped Link: P3	0	0	-	-	-	-	-	-	0.0	0.0	-	-	0.0
C1 Stream: 1 PRC for Signalled Lanes (%): -65.1						Total Delay for Signalled Lanes (pcuHr): 688.95			Cycle Time (s): 120				
C1 Stream: 2 PRC for Signalled Lanes (%): -10.0						Total Delay for Signalled Lanes (pcuHr): 22.17			Cycle Time (s): 120				
PRC Over All Lanes (%): -65.1						Total Delay Over All Lanes(pcuHr): 711.12							

Full Input Data And Results

Scenario 2: 'Option 1 PM Demand' (FG2: 'Option 1 PM Demand', Plan 1: 'Network Control Plan 1')

Stage Sequence Diagram

Stage Stream: 1

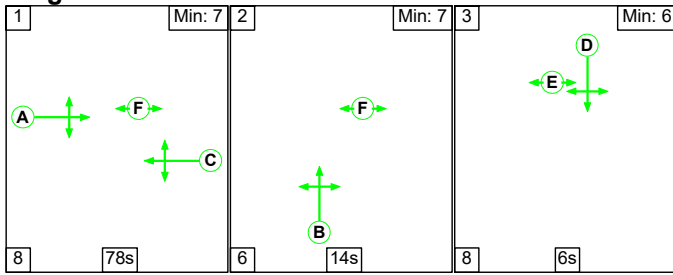

Stage Stream: 2

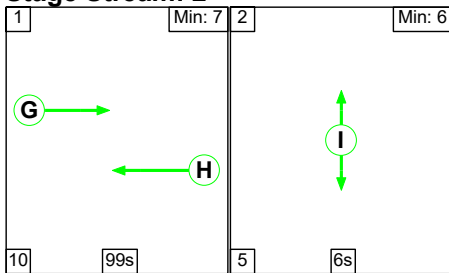

Stage Timings

Stage Stream: 1

Stage	1	2	3
Duration	78	14	6
Change Point	0	86	106

Stage Stream: 2

Stage	1	2
Duration	99	6
Change Point	105	94

Signal Timings Diagram

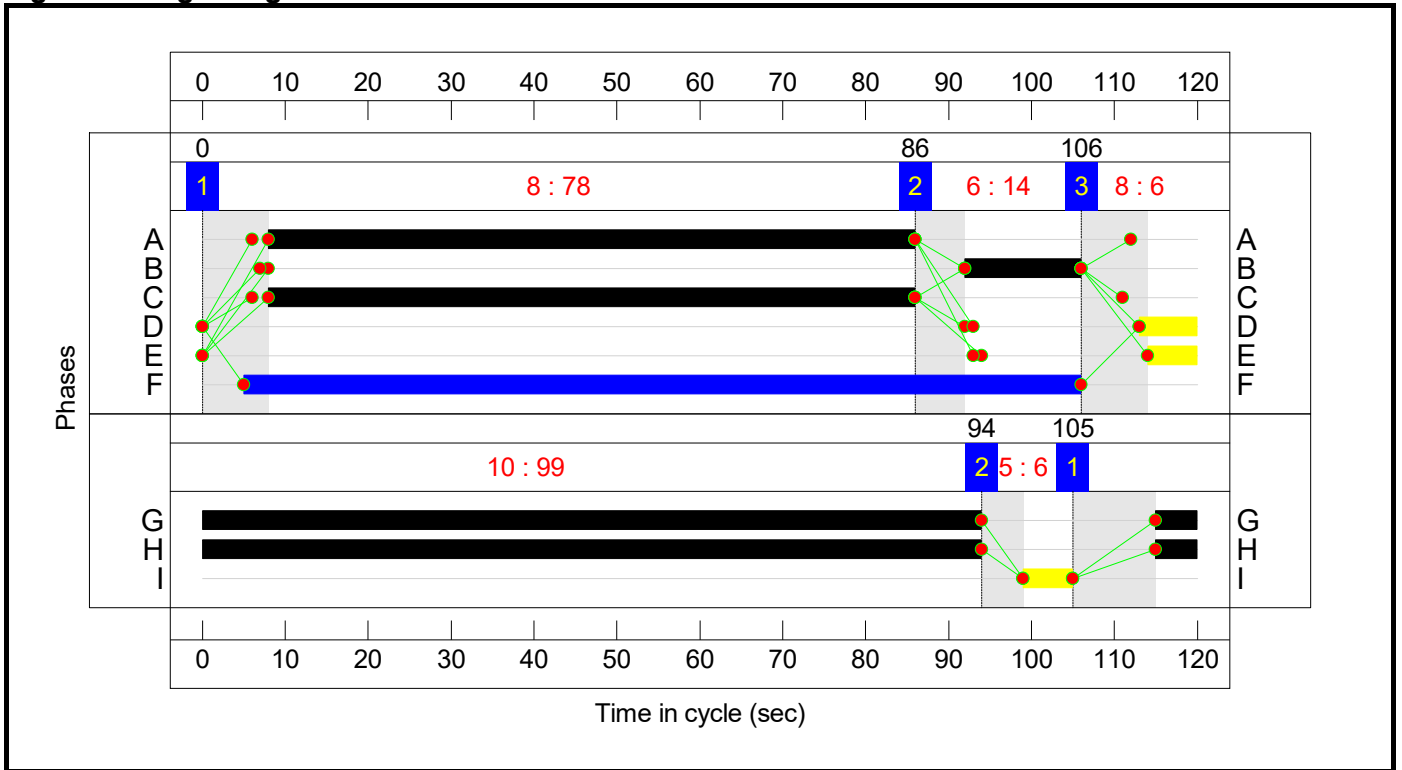

Full Input Data And Results  
**Network Layout Diagram**

Full Input Data And Results

**Unnamed Junction**  
 PRC: -67.3 %  
 Total Traffic Delay: 602.3 pcuHr  
 Ave. Route Delay Per Ped: 0.0 s/Ped

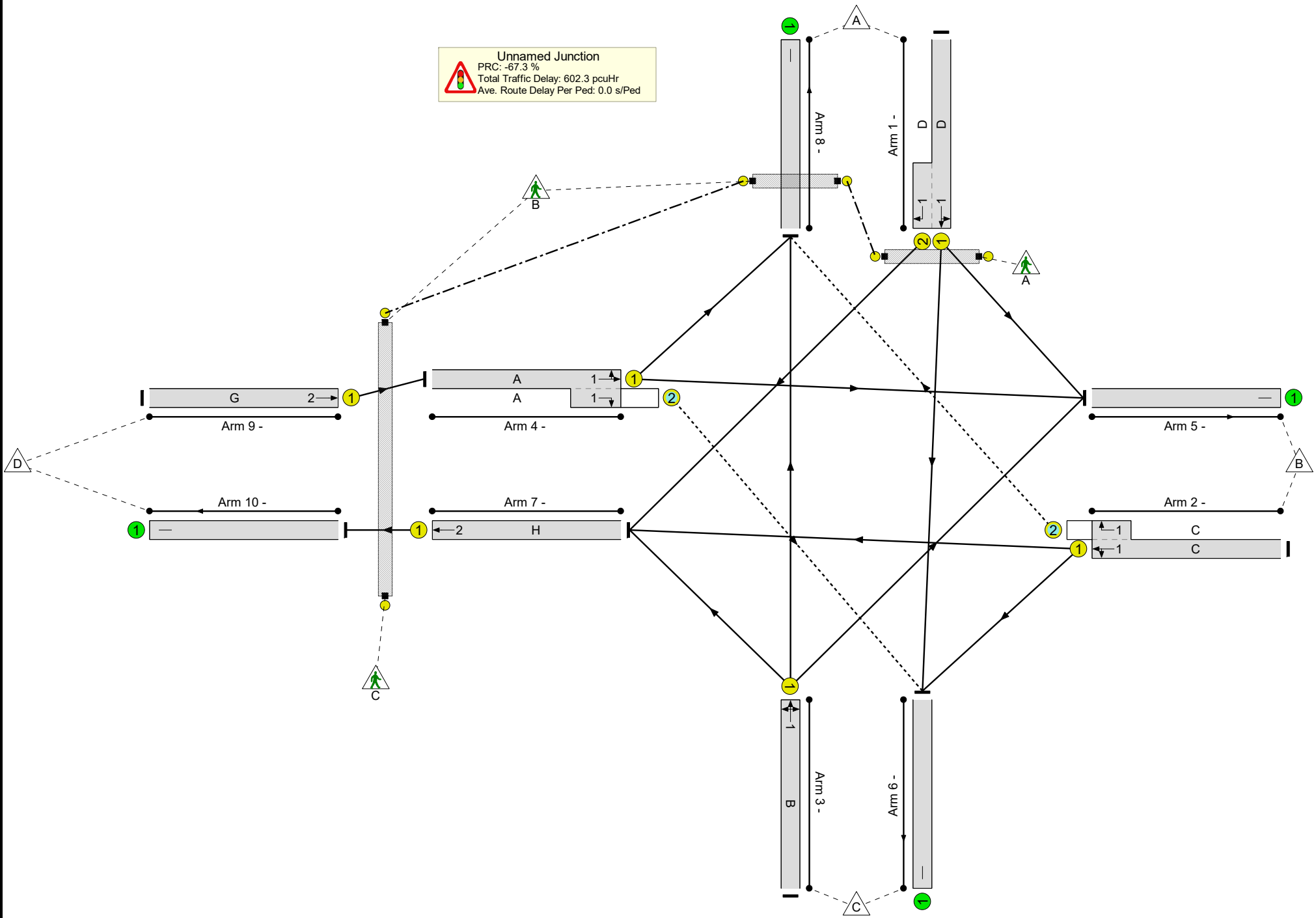

Full Input Data And Results

**Network Results**

Item	Lane Description	Lane Type	Controller Stream	Position In Filtered Route	Full Phase	Arrow Phase	Num Greens	Total Green (s)	Arrow Green (s)	Demand Flow (pcu)	Sat Flow (pcu/Hr)	Capacity (pcu)	Deg Sat (%)
Network	-	-	N/A	-	-		-	-	-	-	-	-	150.5%
Unnamed Junction	-	-	N/A	-	-		-	-	-	-	-	-	150.5%
1/1+1/2	Left Ahead Right	U	1	N/A	D		1	7	-	92	1761:1724	117+31	62.2 : 62.2%
2/1+2/2	Left Ahead Right	U+O	1	N/A	C		1	78	-	1914	1957:1740	1235+45	149.5 : 149.5%
3/1	Right Left Ahead	U	1	N/A	B		1	14	-	318	1690	211	150.5%
4/1+4/2	Ahead Right Left	U+O	1	N/A	A		1	78	-	1520	1919:1634	1181+71	121.5 : 121.5%
5/1		U	N/A	N/A	-		-	-	-	1714	Inf	Inf	0.0%
6/1		U	N/A	N/A	-		-	-	-	639	Inf	Inf	0.0%
7/1	Ahead	U	2	N/A	H		1	99	-	1336	1965	1637	55.0%
8/1		U	N/A	N/A	-		-	-	-	155	Inf	Inf	0.0%
9/1	Ahead	U	2	N/A	G		1	99	-	1520	2015	1679	90.5%
10/1		U	N/A	N/A	-		-	-	-	1336	Inf	Inf	0.0%
Ped Link: P1	Unnamed Ped Link	-	1	-	E		1	6	-	0	-	3600	0.0%
Ped Link: P2	Unnamed Ped Link	-	2	-	I		1	6	-	0	-	3600	0.0%
Ped Link: P3	Unnamed Ped Link	-	1	-	F		1	101	-	0	-	60600	0.0%

Full Input Data And Results

Item	Arriving (pcu)	Leaving (pcu)	Turners In Gaps (pcu)	Turners When Unopposed (pcu)	Turners In Intergreen (pcu)	Uniform Delay (pcuHr)	Rand + Oversat Delay (pcuHr)	Storage Area Uniform Delay (pcuHr)	Total Delay (pcuHr)	Av. Delay Per PCU (s/pcu)	Max. Back of Uniform Queue (pcu)	Rand + Oversat Queue (pcu)	Mean Max Queue (pcu)
Network	-	-	3	0	112	84.8	516.2	1.3	602.3	-	-	-	-
Unnamed Junction	-	-	3	0	112	84.8	516.2	1.3	602.3	-	-	-	-
1/1+1/2	92	92	-	-	-	1.4	0.8	-	2.2	85.5	2.4	0.8	3.2
2/1+2/2	1914	1280	3	0	42	47.6	318.4	0.4	366.5	689.3	89.5	318.4	407.9
3/1	318	211	-	-	-	11.3	54.8	-	66.2	749.1	16.7	54.8	71.6
4/1+4/2	1520	1251	0	0	71	21.6	137.0	0.8	159.5	377.7	62.7	137.0	199.7
5/1	1378	1378	-	-	-	0.0	0.0	-	0.0	0.0	0.0	0.0	0.0
6/1	448	448	-	-	-	0.0	0.0	-	0.0	0.0	0.0	0.0	0.0
7/1	900	900	-	-	-	0.0	0.6	-	0.6	2.4	0.0	0.6	0.6
8/1	109	109	-	-	-	0.0	0.0	-	0.0	0.0	0.0	0.0	0.0
9/1	1520	1520	-	-	-	2.9	4.5	-	7.4	17.5	34.2	4.5	38.7
10/1	900	900	-	-	-	0.0	0.0	-	0.0	0.0	0.0	0.0	0.0
Ped Link: P1	0	0	-	-	-	-	-	-	0.0	0.0	-	-	0.0
Ped Link: P2	0	0	-	-	-	-	-	-	0.0	0.0	-	-	0.0
Ped Link: P3	0	0	-	-	-	-	-	-	0.0	0.0	-	-	0.0
C1 Stream: 1 PRC for Signalled Lanes (%): -67.3						Total Delay for Signalled Lanes (pcuHr): 594.29			Cycle Time (s): 120				
C1 Stream: 2 PRC for Signalled Lanes (%): -0.6						Total Delay for Signalled Lanes (pcuHr): 7.99			Cycle Time (s): 120				
PRC Over All Lanes (%): -67.3						Total Delay Over All Lanes(pcuHr): 602.28							

Full Input Data And Results

Scenario 3: 'Option 2 AM Demand' (FG3: 'Option 2 AM Demand', Plan 1: 'Network Control Plan 1')

Stage Sequence Diagram

Stage Stream: 1

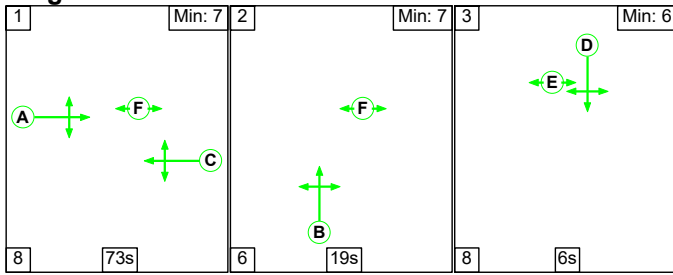

Stage Stream: 2

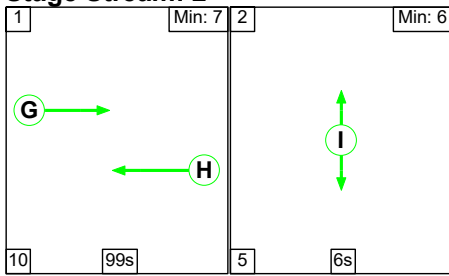

Stage Timings

Stage Stream: 1

Stage	1	2	3
Duration	73	19	6
Change Point	0	81	106

Stage Stream: 2

Stage	1	2
Duration	99	6
Change Point	109	98



Signal Timings Diagram

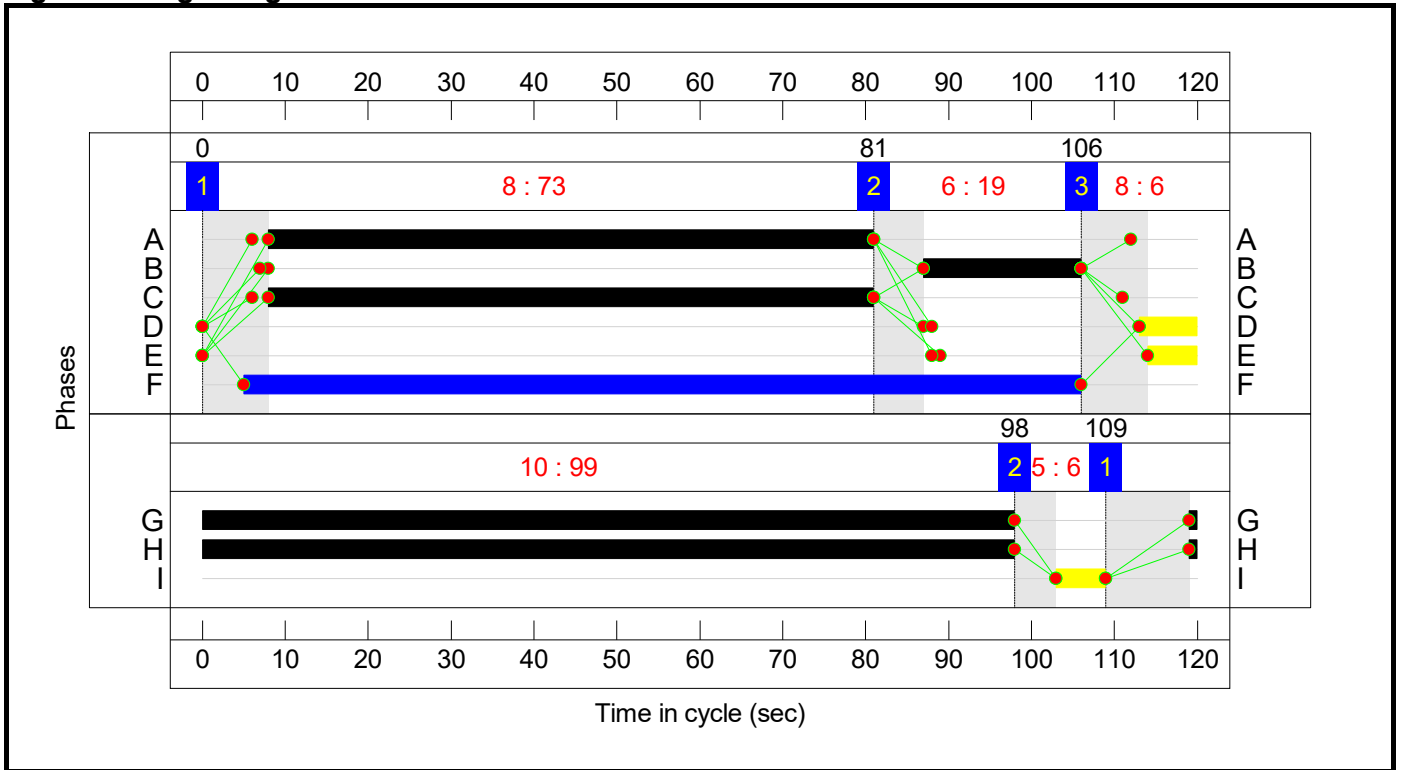

Full Input Data And Results  
**Network Layout Diagram**

Full Input Data And Results

**Unnamed Junction**  
 PRC: -71.9 %  
 Total Traffic Delay: 844.8 pcuHr  
 Ave. Route Delay Per Ped: 0.0 s/Ped

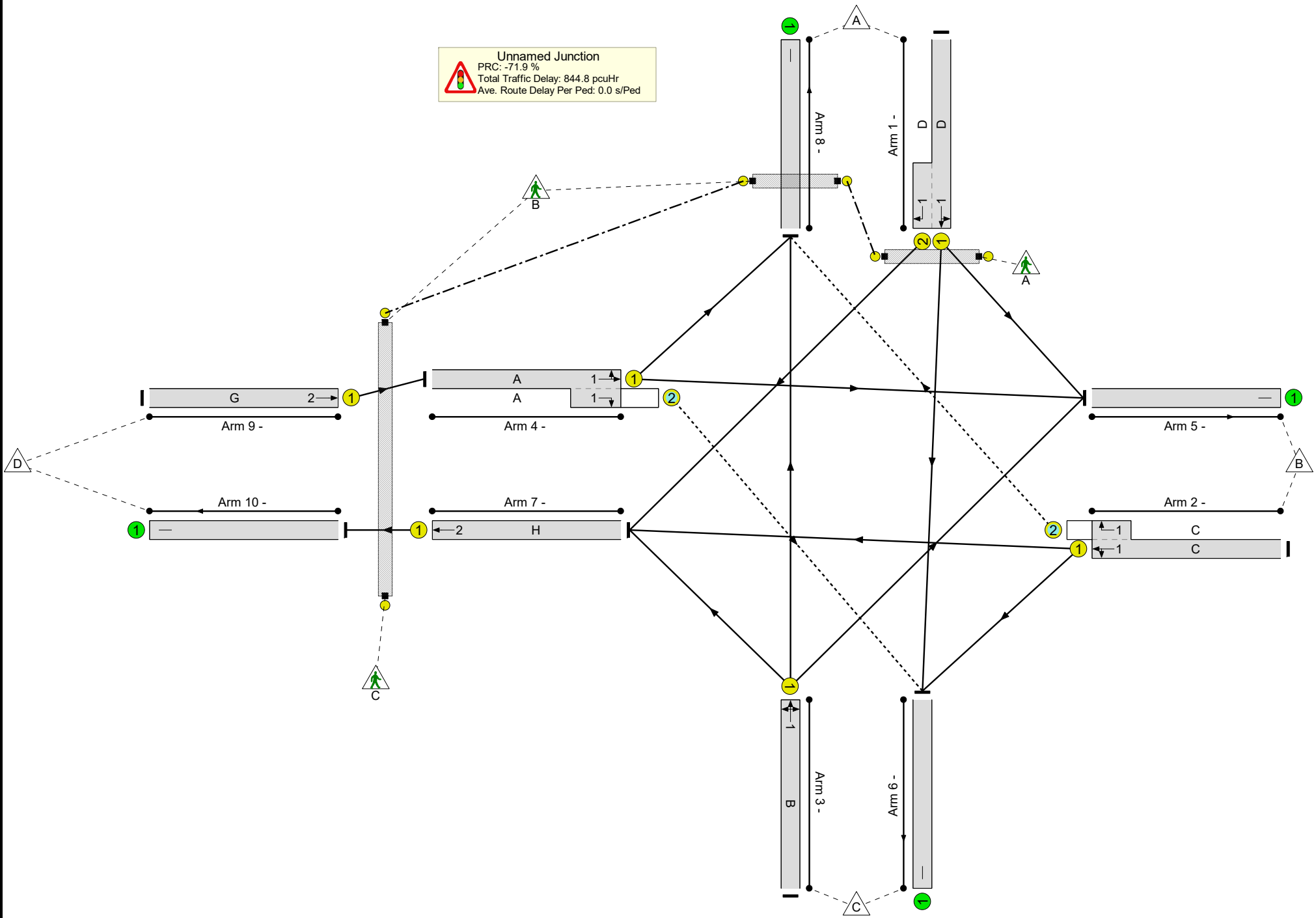

Full Input Data And Results

**Network Results**

Item	Lane Description	Lane Type	Controller Stream	Position In Filtered Route	Full Phase	Arrow Phase	Num Greens	Total Green (s)	Arrow Green (s)	Demand Flow (pcu)	Sat Flow (pcu/Hr)	Capacity (pcu)	Deg Sat (%)
Network	-	-	N/A	-	-		-	-	-	-	-	-	154.7%
Unnamed Junction	-	-	N/A	-	-		-	-	-	-	-	-	154.7%
1/1+1/2	Left Ahead Right	U	1	N/A	D		1	7	-	222	1730:1724	115+115	100.6 : 92.2%
2/1+2/2	Left Ahead Right	U+O	1	N/A	C		1	73	-	1855	1957:1740	1152+47	154.7 : 154.7%
3/1	Right Left Ahead	U	1	N/A	B		1	19	-	419	1658	276	151.6%
4/1+4/2	Ahead Right Left	U+O	1	N/A	A		1	73	-	1782	1902:1634	1108+56	144.3 : 144.3%
5/1		U	N/A	N/A	-		-	-	-	2081	Inf	Inf	0.0%
6/1		U	N/A	N/A	-		-	-	-	427	Inf	Inf	0.0%
7/1	Ahead	U	2	N/A	H		1	99	-	1563	1965	1637	64.0%
8/1		U	N/A	N/A	-		-	-	-	207	Inf	Inf	0.0%
9/1	Ahead	U	2	N/A	G		1	99	-	1782	2015	1679	106.1%
10/1		U	N/A	N/A	-		-	-	-	1563	Inf	Inf	0.0%
Ped Link: P1	Unnamed Ped Link	-	1	-	E		1	6	-	0	-	3600	0.0%
Ped Link: P2	Unnamed Ped Link	-	2	-	I		1	6	-	0	-	3600	0.0%
Ped Link: P3	Unnamed Ped Link	-	1	-	F		1	101	-	0	-	60600	0.0%

Full Input Data And Results

Item	Arriving (pcu)	Leaving (pcu)	Turners In Gaps (pcu)	Turners When Unopposed (pcu)	Turners In Intergreen (pcu)	Uniform Delay (pcuHr)	Rand + Oversat Delay (pcuHr)	Storage Area Uniform Delay (pcuHr)	Total Delay (pcuHr)	Av. Delay Per PCU (s/pcu)	Max. Back of Uniform Queue (pcu)	Rand + Oversat Queue (pcu)	Mean Max Queue (pcu)
<b>Network</b>	-	-	2	0	101	116.4	727.3	1.1	844.8	-	-	-	-
<b>Unnamed Junction</b>	-	-	2	0	101	116.4	727.3	1.1	844.8	-	-	-	-
1/1+1/2	222	221	-	-	-	3.5	6.0	-	9.5	153.5	3.9	6.0	9.9
2/1+2/2	1855	1199	2	0	44	48.9	329.5	0.5	378.9	735.3	86.9	329.5	416.4
3/1	419	276	-	-	-	14.9	72.8	-	87.7	753.3	22.2	72.8	95.0
4/1+4/2	1679	1164	0	0	56	38.6	259.2	0.6	298.5	639.9	77.6	259.2	336.8
5/1	1396	1396	-	-	-	0.0	0.0	-	0.0	0.0	0.0	0.0	0.0
6/1	282	282	-	-	-	0.0	0.0	-	0.0	0.0	0.0	0.0	0.0
7/1	1048	1048	-	-	-	0.1	0.9	-	1.0	3.3	3.5	0.9	4.4
8/1	135	135	-	-	-	0.0	0.0	-	0.0	0.0	0.0	0.0	0.0
9/1	1782	1679	-	-	-	10.4	59.0	-	69.3	140.1	62.8	59.0	121.8
10/1	1048	1048	-	-	-	0.0	0.0	-	0.0	0.0	0.0	0.0	0.0
Ped Link: P1	0	0	-	-	-	-	-	-	0.0	0.0	-	-	0.0
Ped Link: P2	0	0	-	-	-	-	-	-	0.0	0.0	-	-	0.0
Ped Link: P3	0	0	-	-	-	-	-	-	0.0	0.0	-	-	0.0
C1 Stream: 1 PRC for Signalled Lanes (%): -71.9						Total Delay for Signalled Lanes (pcuHr): 774.46			Cycle Time (s): 120				
C1 Stream: 2 PRC for Signalled Lanes (%): -17.9						Total Delay for Signalled Lanes (pcuHr): 70.30			Cycle Time (s): 120				
PRC Over All Lanes (%): -71.9						Total Delay Over All Lanes(pcuHr): 844.77							

Full Input Data And Results

Scenario 4: 'Option 2 PM Demand' (FG4: 'Option 2 PM Demand', Plan 1: 'Network Control Plan 1')

Stage Sequence Diagram

Stage Stream: 1

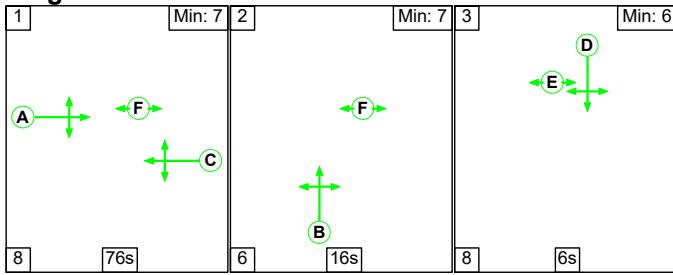

Stage Stream: 2

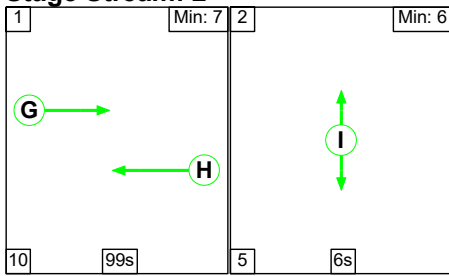

Stage Timings

Stage Stream: 1

Stage	1	2	3
Duration	76	16	6
Change Point	96	60	82

Stage Stream: 2

Stage	1	2
Duration	99	6
Change Point	61	50

Signal Timings Diagram

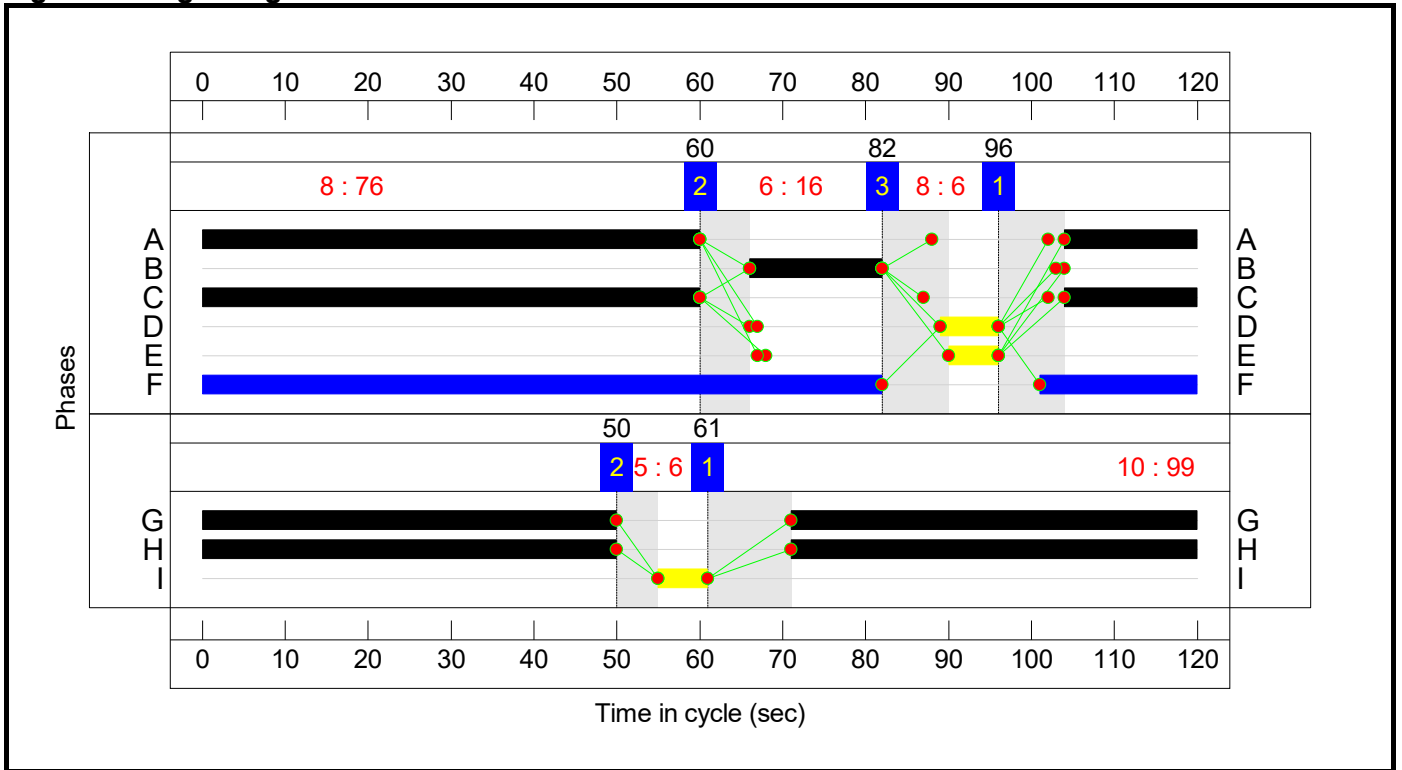

Full Input Data And Results  
**Network Layout Diagram**



# Full Input Data And Results

**Unnamed Junction**  
 PRC: -74.6 %  
 Total Traffic Delay: 763.6 pcuHr  
 Ave. Route Delay Per Ped: 0.0 s/Ped

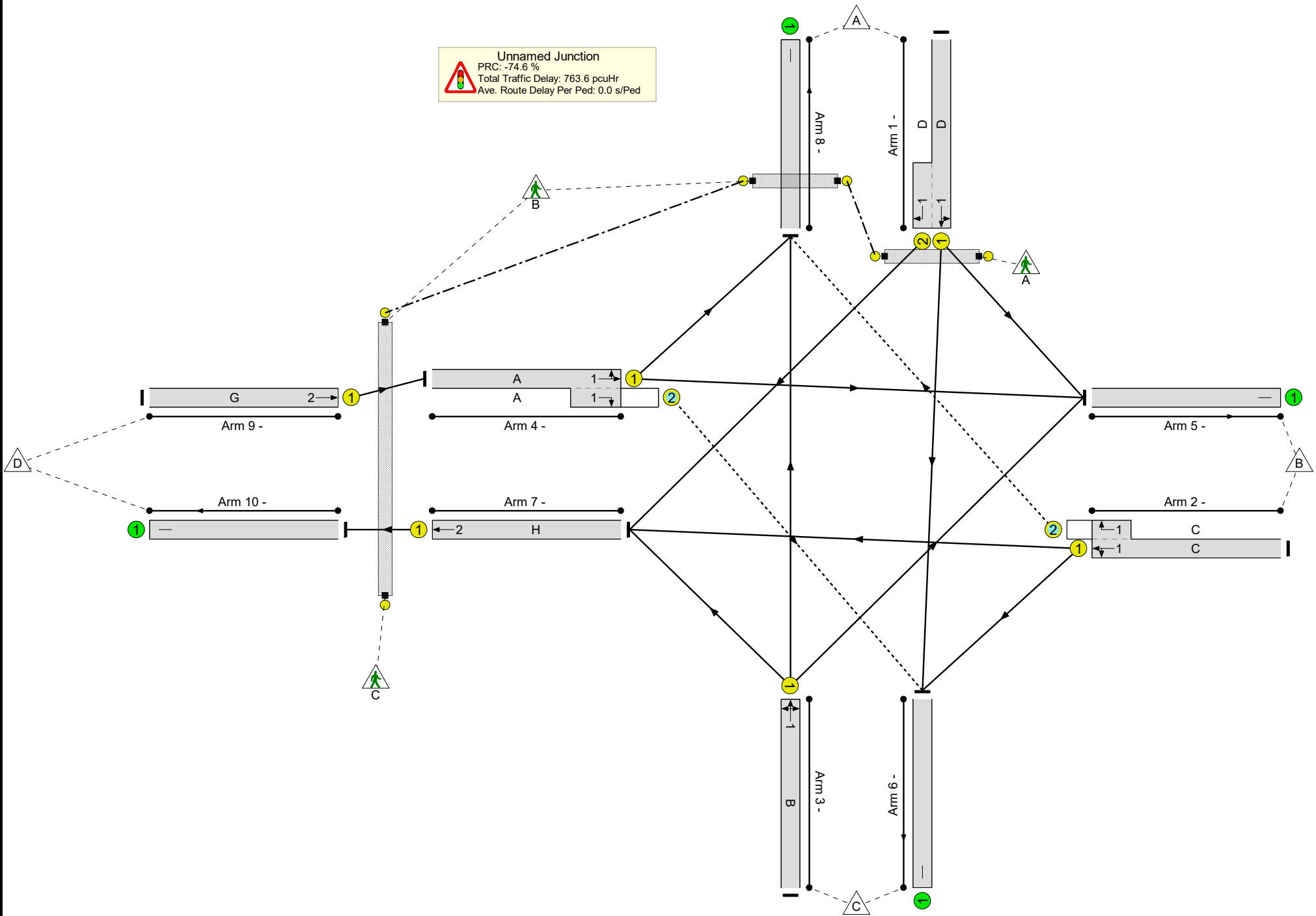

Full Input Data And Results

Network Results

Item	Lane Description	Lane Type	Controller Stream	Position In Filtered Route	Full Phase	Arrow Phase	Num Greens	Total Green (s)	Arrow Green (s)	Demand Flow (pcu)	Sat Flow (pcu/Hr)	Capacity (pcu)	Deg Sat (%)
Network	-	-	N/A	-	-		-	-	-	-	-	-	157.2%
Unnamed Junction	-	-	N/A	-	-		-	-	-	-	-	-	157.2%
1/1+1/2	Left Ahead Right	U	1	N/A	D		1	7	-	92	1761:1724	117+31	62.2 : 62.2%
2/1+2/2	Left Ahead Right	U+O	1	N/A	C		1	76	-	1961	1957:1740	1205+43	157.2 : 157.2%
3/1	Right Left Ahead	U	1	N/A	B		1	16	-	370	1684	239	155.1%
4/1+4/2	Ahead Right Left	U+O	1	N/A	A		1	76	-	1640	1919:1634	1093+119	134.7 : 141.7%
5/1		U	N/A	N/A	-		-	-	-	1804	Inf	Inf	0.0%
6/1		U	N/A	N/A	-		-	-	-	709	Inf	Inf	0.0%
7/1	Ahead	U	2	N/A	H		1	99	-	1395	1965	1637	54.6%
8/1		U	N/A	N/A	-		-	-	-	155	Inf	Inf	0.0%
9/1	Ahead	U	2	N/A	G		1	99	-	1640	2015	1679	97.7%
10/1		U	N/A	N/A	-		-	-	-	1395	Inf	Inf	0.0%
Ped Link: P1	Unnamed Ped Link	-	1	-	E		1	6	-	0	-	3600	0.0%
Ped Link: P2	Unnamed Ped Link	-	2	-	I		1	6	-	0	-	3600	0.0%
Ped Link: P3	Unnamed Ped Link	-	1	-	F		1	101	-	0	-	60600	0.0%

Full Input Data And Results

Item	Arriving (pcu)	Leaving (pcu)	Turners In Gaps (pcu)	Turners When Unopposed (pcu)	Turners In Intergreen (pcu)	Uniform Delay (pcuHr)	Rand + Oversat Delay (pcuHr)	Storage Area Uniform Delay (pcuHr)	Total Delay (pcuHr)	Av. Delay Per PCU (s/pcu)	Max. Back of Uniform Queue (pcu)	Rand + Oversat Queue (pcu)	Mean Max Queue (pcu)																								
Network	-	-	3	0	129	106.0	655.3	2.2	763.6	-	-	-	-																								
Unnamed Junction	-	-	3	0	129	106.0	655.3	2.2	763.6	-	-	-	-																								
1/1+1/2	92	92	-	-	-	1.4	0.8	-	2.2	85.5	2.4	0.8	3.2																								
2/1+2/2	1961	1248	3	0	39	54.7	358.0	0.4	413.2	758.5	90.9	358.0	448.9																								
3/1	370	239	-	-	-	12.1	67.1	-	79.2	770.2	17.5	67.1	84.6																								
4/1+4/2	1640	1211	0	0	90	33.1	216.1	1.8	251.0	550.9	68.6	216.1	284.7																								
5/1	1321	1321	-	-	-	0.0	0.0	-	0.0	0.0	0.0	0.0	0.0																								
6/1	443	443	-	-	-	0.0	0.0	-	0.0	0.0	0.0	0.0	0.0																								
7/1	894	894	-	-	-	0.7	0.6	-	1.3	5.3	4.8	0.6	5.4																								
8/1	103	103	-	-	-	0.0	0.0	-	0.0	0.0	0.0	0.0	0.0																								
9/1	1640	1640	-	-	-	4.1	12.7	-	16.8	36.8	48.7	12.7	61.4																								
10/1	894	894	-	-	-	0.0	0.0	-	0.0	0.0	0.0	0.0	0.0																								
Ped Link: P1	0	0	-	-	-	-	-	-	0.0	0.0	-	-	0.0																								
Ped Link: P2	0	0	-	-	-	-	-	-	0.0	0.0	-	-	0.0																								
Ped Link: P3	0	0	-	-	-	-	-	-	0.0	0.0	-	-	0.0																								
<table border="0" style="width: 100%; border-collapse: collapse;"> <tr> <td style="width: 15%;"></td> <td style="width: 15%;">C1</td> <td style="width: 15%;">Stream: 1 PRC for Signalled Lanes (%):</td> <td style="width: 15%;">-74.6</td> <td style="width: 15%;">Total Delay for Signalled Lanes (pcuHr):</td> <td style="width: 15%;">745.49</td> <td style="width: 15%;">Cycle Time (s):</td> <td style="width: 15%;">120</td> </tr> <tr> <td></td> <td>C1</td> <td>Stream: 2 PRC for Signalled Lanes (%):</td> <td>-8.5</td> <td>Total Delay for Signalled Lanes (pcuHr):</td> <td>18.11</td> <td>Cycle Time (s):</td> <td>120</td> </tr> <tr> <td></td> <td></td> <td>PRC Over All Lanes (%):</td> <td>-74.6</td> <td>Total Delay Over All Lanes (pcuHr):</td> <td>763.59</td> <td></td> <td></td> </tr> </table>															C1	Stream: 1 PRC for Signalled Lanes (%):	-74.6	Total Delay for Signalled Lanes (pcuHr):	745.49	Cycle Time (s):	120		C1	Stream: 2 PRC for Signalled Lanes (%):	-8.5	Total Delay for Signalled Lanes (pcuHr):	18.11	Cycle Time (s):	120			PRC Over All Lanes (%):	-74.6	Total Delay Over All Lanes (pcuHr):	763.59		
	C1	Stream: 1 PRC for Signalled Lanes (%):	-74.6	Total Delay for Signalled Lanes (pcuHr):	745.49	Cycle Time (s):	120																														
	C1	Stream: 2 PRC for Signalled Lanes (%):	-8.5	Total Delay for Signalled Lanes (pcuHr):	18.11	Cycle Time (s):	120																														
		PRC Over All Lanes (%):	-74.6	Total Delay Over All Lanes (pcuHr):	763.59																																

**Appendix N**  
**Sandhurst Road Junction Existing Layout Modelling Results**

Junctions 10
PICADY 10 - Priority Intersection Module
Version: 10.1.1.1905 © Copyright TRL Software Limited, 2023
For sales and distribution information, program advice and maintenance, contact TRL Software: +44 (0)1344 379777 software@trl.co.uk trlsoftware.com
The users of this computer program for the solution of an engineering problem are in no way relieved of their responsibility for the correctness of the solution

**Filename:** Pembury Road\_Sandhurst Road (Existing Layout).j10  
**Path:** J:\332611481 - GH - Tunbridge Wells Local Plan\BRIEF 100 - Pembury Road\MODELLING\TRANSPORT\03. JUNCTIONS 10  
**Report generation date:** 14/05/2024 11:03:09

- »Option 1 Demand, AM
- »Option 1 Demand, PM
- »Option 2 Demand, AM
- »Option 2 Demand, PM

**Summary of junction performance**

	AM				PM			
	Q (PCU)	Delay (s)	RFC	Junction Delay (s)	Q (PCU)	Delay (s)	RFC	Junction Delay (s)
Option 1 Demand								
Stream B-AC	941.2	59999940.00	9999999999.00	13377766.17	836.8	59999940.00	9999999999.00	13268144.10
Stream C-AB	267.5	1582.54	1.42		212.0	1173.70	1.37	
Option 2 Demand								
Stream B-AC	1073.8	59999940.00	9999999999.00	14542525.24	890.3	59999940.00	9999999999.00	13725221.37
Stream C-AB	297.0	1712.48	1.46		232.9	1346.32	1.40	

*There are warnings associated with one or more model runs - see the 'Data Errors and Warnings' tables for each Analysis or Demand Set.*

*Values shown are the highest values encountered over all time segments. Delay is the maximum value of Av. delay per arriving vehicle. Junction LOS and Junction Delay are demand-weighted Av.s.*

**File summary**

**File Description**

<b>Title</b>	
<b>Location</b>	
<b>Site number</b>	
<b>Date</b>	25/04/2024
<b>Version</b>	
<b>Status</b>	(new file)
<b>Identifier</b>	
<b>Client</b>	
<b>Jobnumber</b>	
<b>Enumerator</b>	CORP\dansmith
<b>Description</b>	

**Units**

Distance units	Speed units	Traffic units input	Traffic units results	Flow units	Av. delay units	Total delay units	Rate of delay units
m	kph	PCU	PCU	perHour	s	-Min	perMin



Flows show original traffic demand (PCU/hr).  
Streams (downstream end) show RFC ( )

*The junction diagram reflects the last run of Junctions.*

**Analysis Options**

Vehicle length (m)	Calculate Q Percentiles	Calculate detailed queueing delay	Show lane queues in feet / metres	Show all PICADY stream intercepts	Calculate residual capacity	RFC Threshold	Av. Delay threshold (s)	Q threshold (PCU)	Use simulation for HCM roundabouts	Use iterations for HCM roundabouts
5.75						0.85	36.00	20.00		

**Demand Set Summary**

ID	Scenario name	Time Period name	Traffic profile type	Start time (HH:mm)	Finish time (HH:mm)	Time segment length (min)	Run automatically
D1	Option 1 Demand	AM	ONE HOUR	07:15	08:45	15	✓
D2	Option 1 Demand	PM	ONE HOUR	16:45	18:15	15	✓
D3	Option 2 Demand	AM	ONE HOUR	07:15	08:45	15	✓
D4	Option 2 Demand	PM	ONE HOUR	16:45	18:15	15	✓

**Analysis Set Details**

ID	Include in report	Network flow scaling factor (%)	Network capacity scaling factor (%)
A1	✓	100.000	100.000



# Option 1 Demand, AM

## Data Errors and Warnings

Severity	Area	Item	Description
Warning	Vehicle Mix		HV% is zero for all movements / time segments. Vehicle Mix matrix should be completed whether working in PCUs or Vehs. If HV% at the junction is genuinely zero, please ignore this warning.

## Junction Network

### Junctions

Junction	Name	Junction type	Arm A Direction	Arm B Direction	Arm C Direction	Use circulating lanes	Junction Delay (s)	Junction LOS
1	Sandhurst Road / Pembury Road	T-Junction	Two-way	Two-way	Two-way		13377766.17	F

### Junction Network

Driving side	Lighting	Network delay (s)	Network LOS
Left	Normal/unknown	13377766.17	F

## Arms

### Arms

Arm	Name	Description	Arm type
A	Pembury Road West		Major
B	Sandhurst Road		Minor
C	Pembury Road East		Major

### Major Arm Geometry

Arm	Width of carriageway (m)	Has kerbed central reserve	Has right-turn storage	Width for right-turn storage (m)	Visibility for right turn (m)	Blocks?	Blocking queue (PCU)
C - Pembury Road East	6.82		✓	2.84	250.0	✓	9.00

Geometries for Arm C are measured opposite Arm B. Geometries for Arm A (if relevant) are measured opposite Arm D.

### Minor Arm Geometry

Arm	Minor arm type	Lane width (m)	Visibility to left (m)	Visibility to right (m)
B - Sandhurst Road	One lane	4.58	31	32

## Slope / Intercept / Capacity

### Priority Intersection Slopes and Intercepts

Stream	Intercept (PCU/hr)	Slope for A-B	Slope for A-C	Slope for C-A	Slope for C-B
B-A	583	0.097	0.246	0.155	0.351
B-C	746	0.116	0.293	-	-
C-B	769	0.287	0.287	-	-

The slopes and intercepts shown above include custom intercept adjustments only.

Streams may be combined, in which case capacity will be adjusted.

Values are shown for the first time segment only; they may differ for subsequent time segments.



## Traffic Demand

### Demand Set Details

ID	Scenario name	Time Period name	Traffic profile type	Start time (HH:mm)	Finish time (HH:mm)	Time segment length (min)	Run automatically
D1	Option 1 Demand	AM	ONE HOUR	07:15	08:45	15	✓

### Demand overview (Traffic)

Arm	Linked arm	Profile type	Use O-D data	Av. Demand (PCU/hr)	Scaling Factor (%)
A - Pembury Road West		ONE HOUR	✓	1181	100.000
B - Sandhurst Road		ONE HOUR	✓	779	100.000
C - Pembury Road East		ONE HOUR	✓	1534	100.000

## Origin-Destination Data

### Demand (PCU/hr)

From	To			
	A - Pembury Road West	B - Sandhurst Road	C - Pembury Road East	
A - Pembury Road West	0	180	1001	
B - Sandhurst Road	117	0	662	
C - Pembury Road East	1023	511	0	

## Vehicle Mix

HV data entry mode	PCU Factor for a HV (PCU)
HV Percentages	2.00

### Heavy Vehicle %

From	To			
	A - Pembury Road West	B - Sandhurst Road	C - Pembury Road East	
A - Pembury Road West	0	0	0	
B - Sandhurst Road	0	0	0	
C - Pembury Road East	0	0	0	

## Results

### Results Summary for whole modelled period

Stream	Max RFC	Max Delay (s)	Max Q (PCU)	Max LOS	Av. Demand (PCU/hr)	Total Junction Arrivals (PCU)
B-AC	999999999.00	59999940.00	941.2	F	715	1072
C-AB	1.42	1582.54	267.5	F	1137	1706
C-A					270	405
A-B					165	248
A-C					919	1378

# Option 1 Demand, PM

## Data Errors and Warnings

Severity	Area	Item	Description
Warning	Vehicle Mix		HV% is zero for all movements / time segments. Vehicle Mix matrix should be completed whether working in PCUs or Vehs. If HV% at the junction is genuinely zero, please ignore this warning.

## Junction Network

### Junctions

Junction	Name	Junction type	Arm A Direction	Arm B Direction	Arm C Direction	Use circulating lanes	Junction Delay (s)	Junction LOS
1	Sandhurst Road / Pembury Road	T-Junction	Two-way	Two-way	Two-way		13268144.10	F

### Junction Network

Driving side	Lighting	Network delay (s)	Network LOS
Left	Normal/unknown	13268144.10	F

## Traffic Demand

### Demand Set Details

ID	Scenario name	Time Period name	Traffic profile type	Start time (HH:mm)	Finish time (HH:mm)	Time segment length (min)	Run automatically
D2	Option 1 Demand	PM	ONE HOUR	16:45	18:15	15	✓

### Demand overview (Traffic)

Arm	Linked arm	Profile type	Use O-D data	Av. Demand (PCU/hr)	Scaling Factor (%)
A - Pembury Road West		ONE HOUR	✓	1118	100.000
B - Sandhurst Road		ONE HOUR	✓	697	100.000
C - Pembury Road East		ONE HOUR	✓	1337	100.000

## Origin-Destination Data

### Demand (PCU/hr)

		To		
		A - Pembury Road West	B - Sandhurst Road	C - Pembury Road East
From	A - Pembury Road West	0	103	1015
	B - Sandhurst Road	191	0	506
	C - Pembury Road East	820	517	0

## Vehicle Mix

HV data entry mode	PCU Factor for a HV (PCU)
HV Percentages	2.00

### Heavy Vehicle %

		To		
		A - Pembury Road West	B - Sandhurst Road	C - Pembury Road East
From	A - Pembury Road West	0	0	0
	B - Sandhurst Road	0	0	0
	C - Pembury Road East	0	0	0

## Results

### Results Summary for whole modelled period

Stream	Max RFC	Max Delay (s)	Max Q (PCU)	Max LOS	Av. Demand (PCU/hr)	Total Junction Arrivals (PCU)
B-AC	999999999.00	59999940.00	836.8	F	640	959
C-AB	1.37	1173.70	212.0	F	963	1445
C-A					264	395
A-B					95	142
A-C					931	1397

# Option 2 Demand, AM

## Data Errors and Warnings

Severity	Area	Item	Description
Warning	Vehicle Mix		HV% is zero for all movements / time segments. Vehicle Mix matrix should be completed whether working in PCUs or Vehs. If HV% at the junction is genuinely zero, please ignore this warning.

## Junction Network

### Junctions

Junction	Name	Junction type	Arm A Direction	Arm B Direction	Arm C Direction	Use circulating lanes	Junction Delay (s)	Junction LOS
1	Sandhurst Road / Pembury Road	T-Junction	Two-way	Two-way	Two-way		14542525.24	F

### Junction Network

Driving side	Lighting	Network delay (s)	Network LOS
Left	Normal/unknown	14542525.24	F

## Traffic Demand

### Demand Set Details

ID	Scenario name	Time Period name	Traffic profile type	Start time (HH:mm)	Finish time (HH:mm)	Time segment length (min)	Run automatically
D3	Option 2 Demand	AM	ONE HOUR	07:15	08:45	15	✓

### Demand overview (Traffic)

Arm	Linked arm	Profile type	Use O-D data	Av. Demand (PCU/hr)	Scaling Factor (%)
A - Pembury Road West		ONE HOUR	✓	1166	100.000
B - Sandhurst Road		ONE HOUR	✓	873	100.000
C - Pembury Road East		ONE HOUR	✓	1563	100.000

## Origin-Destination Data

### Demand (PCU/hr)

	To			
		A - Pembury Road West	B - Sandhurst Road	C - Pembury Road East
From	A - Pembury Road West	0	156	1010
	B - Sandhurst Road	121	0	752
	C - Pembury Road East	1034	529	0

## Vehicle Mix

HV data entry mode	PCU Factor for a HV (PCU)
HV Percentages	2.00

### Heavy Vehicle %

	To			
		A - Pembury Road West	B - Sandhurst Road	C - Pembury Road East
From	A - Pembury Road West	0	0	0
	B - Sandhurst Road	0	0	0
	C - Pembury Road East	0	0	0

# Results

## Results Summary for whole modelled period

Stream	Max RFC	Max Delay (s)	Max Q (PCU)	Max LOS	Av. Demand (PCU/hr)	Total Junction Arrivals (PCU)
B-AC	999999999.00	59999940.00	1073.8	F	801	1202
C-AB	1.46	1712.48	297.0	F	1194	1791
C-A					240	360
A-B					143	215
A-C					927	1390

# Option 2 Demand, PM

## Data Errors and Warnings

Severity	Area	Item	Description
Warning	Vehicle Mix		HV% is zero for all movements / time segments. Vehicle Mix matrix should be completed whether working in PCUs or Vehs. If HV% at the junction is genuinely zero, please ignore this warning.

## Junction Network

### Junctions

Junction	Name	Junction type	Arm A Direction	Arm B Direction	Arm C Direction	Use circulating lanes	Junction Delay (s)	Junction LOS
1	Sandhurst Road / Pembury Road	T-Junction	Two-way	Two-way	Two-way		13725221.37	F

### Junction Network

Driving side	Lighting	Network delay (s)	Network LOS
Left	Normal/unknown	13725221.37	F

## Traffic Demand

### Demand Set Details

ID	Scenario name	Time Period name	Traffic profile type	Start time (HH:mm)	Finish time (HH:mm)	Time segment length (min)	Run automatically
D4	Option 2 Demand	PM	ONE HOUR	16:45	18:15	15	✓

### Demand overview (Traffic)

Arm	Linked arm	Profile type	Use O-D data	Av. Demand (PCU/hr)	Scaling Factor (%)
A - Pembury Road West		ONE HOUR	✓	1127	100.000
B - Sandhurst Road		ONE HOUR	✓	748	100.000
C - Pembury Road East		ONE HOUR	✓	1395	100.000

## Origin-Destination Data

### Demand (PCU/hr)

		To		
		A - Pembury Road West	B - Sandhurst Road	C - Pembury Road East
From	A - Pembury Road West	0	103	1024
	B - Sandhurst Road	131	0	617
	C - Pembury Road East	872	523	0

## Vehicle Mix

HV data entry mode	PCU Factor for a HV (PCU)
HV Percentages	2.00

### Heavy Vehicle %

		To		
		A - Pembury Road West	B - Sandhurst Road	C - Pembury Road East
From	A - Pembury Road West	0	0	0
	B - Sandhurst Road	0	0	0
	C - Pembury Road East	0	0	0

## Results

### Results Summary for whole modelled period

Stream	Max RFC	Max Delay (s)	Max Q (PCU)	Max LOS	Av. Demand (PCU/hr)	Total Junction Arrivals (PCU)
B-AC	999999999.00	59999940.00	890.3	F	686	1030
C-AB	1.40	1346.32	232.9	F	1035	1553
C-A					245	367
A-B					95	142
A-C					940	1409

**Appendix O**  
**Sandhurst Road Junction Potential Junction Improvements Drawing**



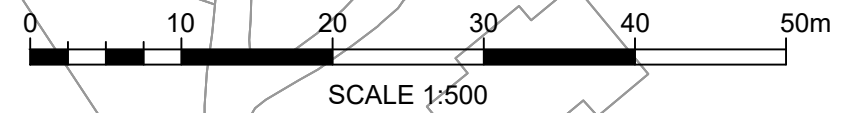
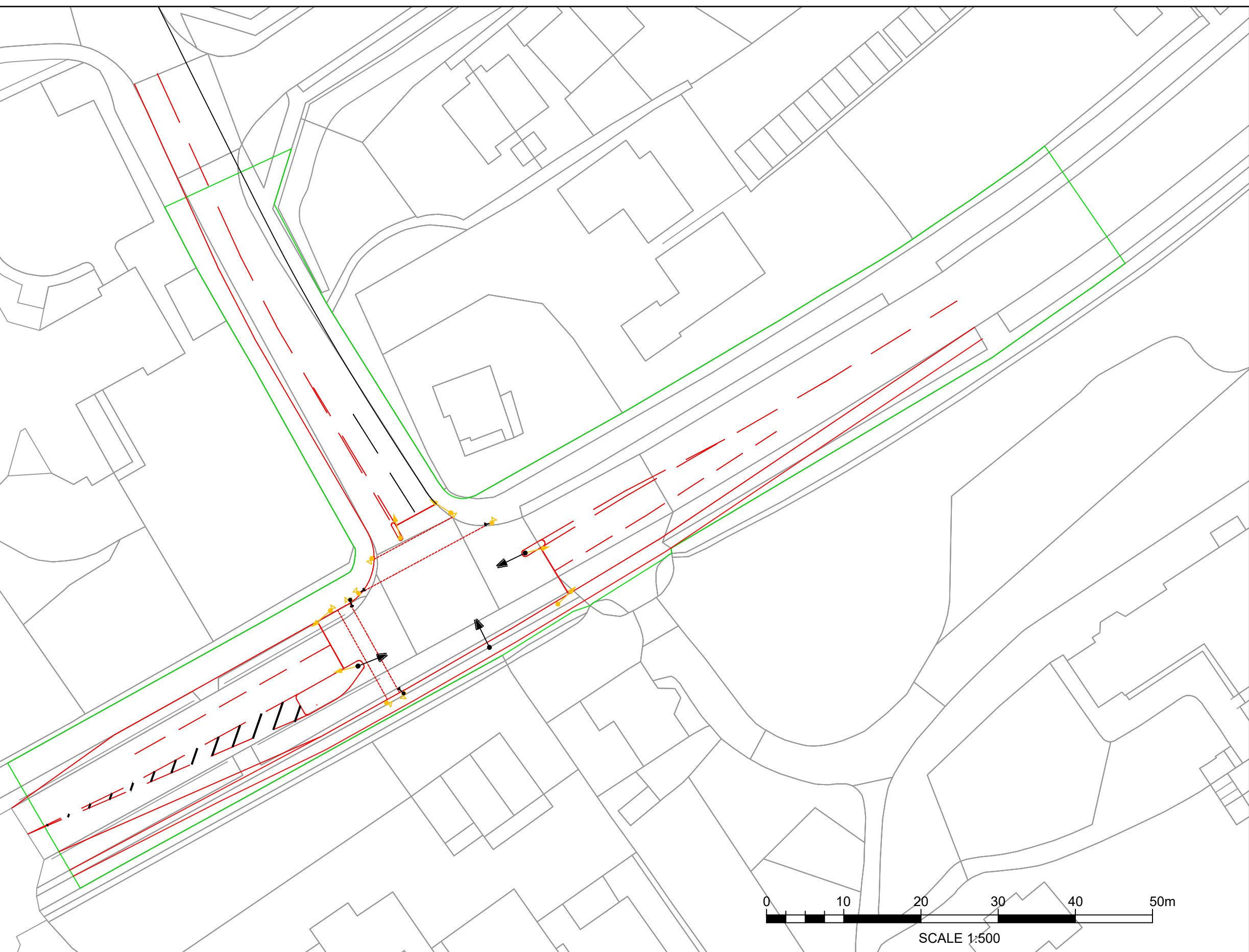

Plotted: 27.06.2024 06:27 8:26:00 AM By: Smith, Daniel  
ORIGINAL SHEET - ISCA3  
J:\332611481 - gh - tunbridge wells local plan\3-autocad\drawings\100\332611481-str-hgn-h-0007 - pembury road junctions mitigation - sandhurst road



Stantec UK Limited  
Unit 10, Connect 38, 1 Dover Place  
Ashford  
TN23 1FB  
Tel. +44 1233 527 250  
www.stantec.com/uk

### S2 FOR INFORMATION

Client/Project:  
TWBC  
  
TUNBRIDGE WELLS  
LOCAL PLAN

Project No.:  
332611481

Title  
PEMBURY ROAD POTENTIAL  
MITIGATION SCHEME -  
SANDHURST ROAD  
JUNCTION

Revision:	Date:	Drawing No.
-	2024.05.13	0007

**Appendix Q**  
**Sandhurst Road Junction Potential Junction Improvements Modelling Results**

Full Input Data And Results  
**Full Input Data And Results**

**User and Project Details**

<b>Project:</b>	
<b>Title:</b>	
<b>Location:</b>	
<b>Additional detail:</b>	
<b>File name:</b>	Sandhurst Road (Mitigation Layout - Left Filter + Peds).lsg3x
<b>Author:</b>	D.Smith
<b>Company:</b>	Stantec UK
<b>Address:</b>	

**Network Layout Diagram**

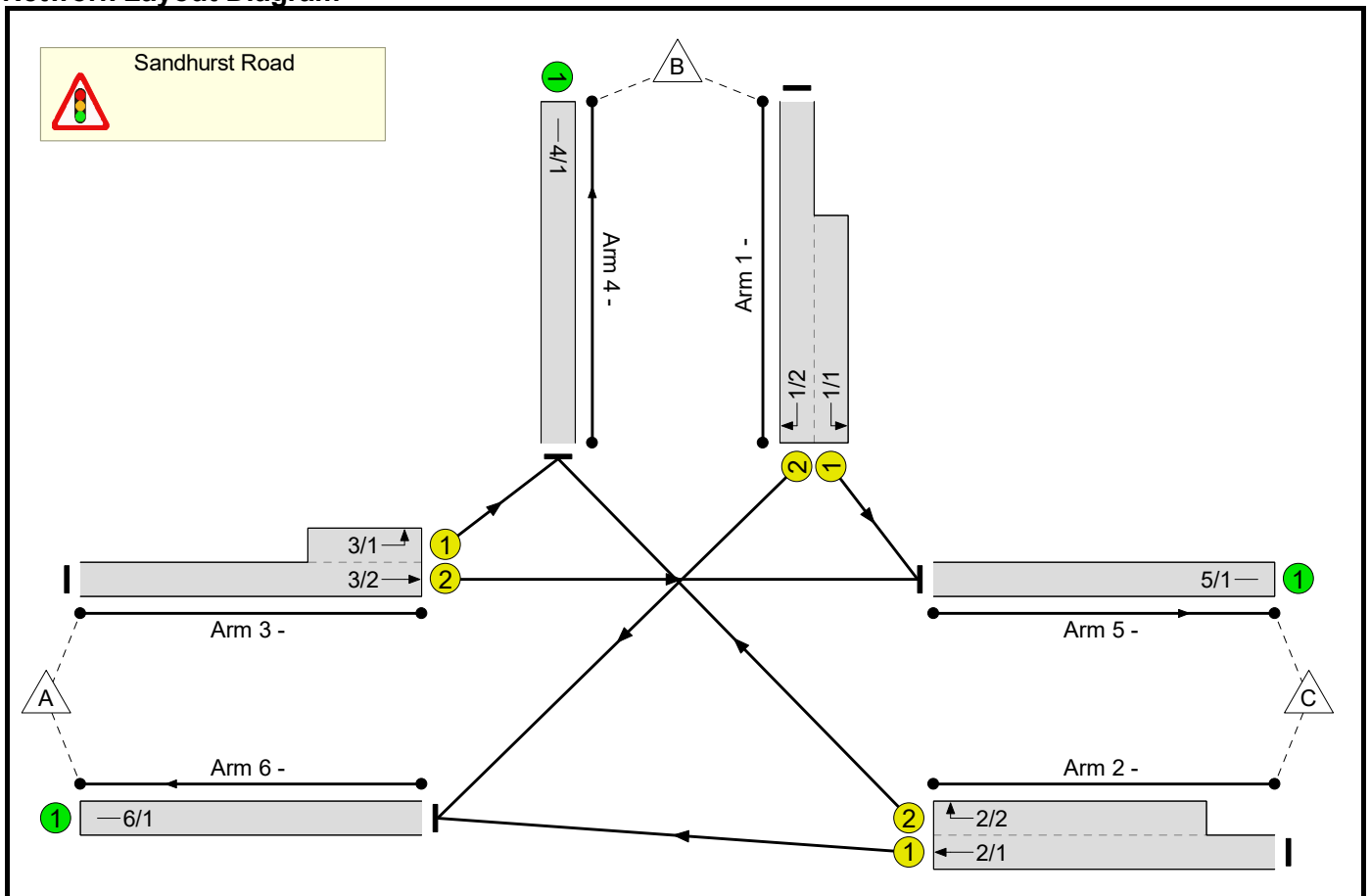

**Phase Diagram**

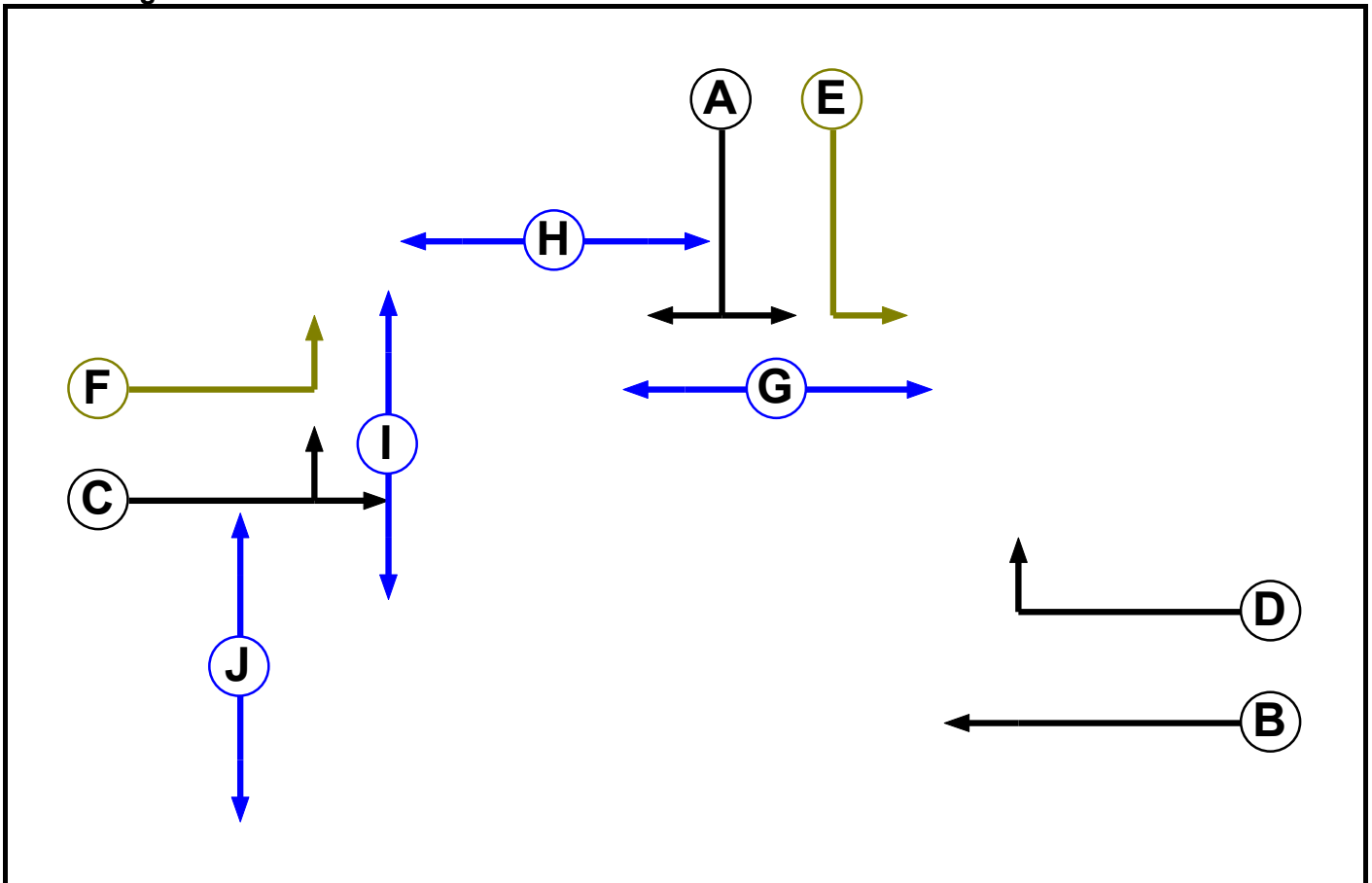

**Phase Input Data**

Phase Name	Phase Type	Assoc. Phase	Street Min	Cont Min
A	Traffic		7	7
B	Traffic		7	7
C	Traffic		7	7
D	Traffic		7	7
E	Filter	A	4	0
F	Filter	C	4	0
G	Pedestrian		6	6
H	Pedestrian		6	6
I	Pedestrian		6	6
J	Pedestrian		6	6

**Phase Intergrens Matrix**

		Starting Phase									
		A	B	C	D	E	F	G	H	I	J
Terminating Phase	A		5	5	5	-	-	5	-	-	8
	B	5		-	-	-	5	-	8	-	8
	C	5	-		5	5	-	-	-	5	-
	D	5	-	5		-	5	-	8	-	-
	E	-	-	5	-		-	5	-	-	-
	F	-	5	-	5	-		-	6	5	-
	G	9	-	-	-	9	-		-	-	-
	H	-	7	-	7	-	7	-		-	-
	I	-	-	9	-	-	9	-	-		-
	J	7	7	-	-	-	-	-	-	-	

**Phases in Stage**

Stage No.	Phases in Stage
1	A F
2	B C G
3	G H I J
4	B D E I

**Stage Diagram**

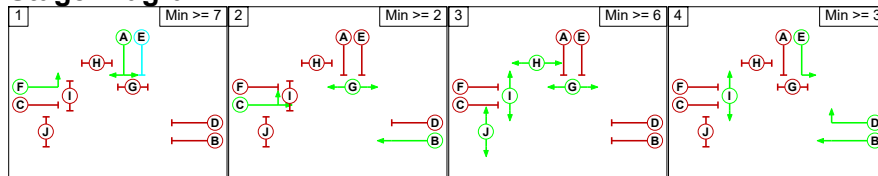

**Phase Delays**

Term. Stage	Start Stage	Phase	Type	Value	Cont value
4	1	B	Losing	4	4

**Prohibited Stage Change**

		To Stage			
		1	2	3	4
From Stage	1		10	X	X
	2	9		8	9
	3	9	9		9
	4	9	X	X	

Full Input Data And Results

**Give-Way Lane Input Data**

**Junction: Sandhurst Road**

There are no Opposed Lanes in this Junction

Full Input Data And Results

**Lane Input Data**

Junction: Sandhurst Road												
Lane	Lane Type	Phases	Start Disp.	End Disp.	Physical Length (PCU)	Sat Flow Type	Def User Saturation Flow (PCU/Hr)	Lane Width (m)	Gradient	Nearside Lane	Turns	Turning Radius (m)
1/1	U	A E	2	3	10.0	Geom	-	3.50	0.00	Y	Arm 5 Left	10.00
1/2	U	A	2	3	60.0	Geom	-	3.50	0.00	Y	Arm 6 Right	15.00
2/1	U	B	2	3	60.0	Geom	-	3.50	0.00	Y	Arm 6 Ahead	Inf
2/2	U	D	2	3	15.0	Geom	-	3.50	0.00	Y	Arm 4 Right	15.00
3/1	U	C F	2	3	5.0	Geom	-	3.50	0.00	Y	Arm 4 Left	10.00
3/2	U	C	2	3	60.0	Geom	-	3.50	0.00	Y	Arm 5 Ahead	Inf
4/1	U		2	3	60.0	Inf	-	-	-	-	-	-
5/1	U		2	3	60.0	Inf	-	-	-	-	-	-
6/1	U		2	3	60.0	Inf	-	-	-	-	-	-

**Traffic Flow Groups**

Flow Group	Start Time	End Time	Duration	Formula
1: 'Option 1 AM Demand'	08:00	09:00	01:00	
2: 'Option 1 PM Demand'	17:00	18:00	01:00	
3: 'Option 2 AM Demand'	08:00	09:00	01:00	
4: 'Option 2 PM Demand'	17:00	18:00	01:00	

**Scenario 1: 'Option 1 AM Demand'** (FG1: 'Option 1 AM Demand', Plan 1: 'Network Control Plan 1')

**Traffic Flows, Desired**

**Desired Flow :**

	Destination				
	A	B	C	Tot.	
Origin	A	0	180	1001	1181
	B	117	0	662	779
	C	1023	511	0	1534
	Tot.	1140	691	1663	3494

Full Input Data And Results

**Traffic Lane Flows**

Scenario 1: Option 1 AM Demand	
<b>Junction: Sandhurst Road</b>	
1/1 (short)	662
1/2 (with short)	779(In) 117(Out)
2/1 (with short)	1534(In) 1023(Out)
2/2 (short)	511
3/1 (short)	180
3/2 (with short)	1181(In) 1001(Out)
4/1	691
5/1	1663
6/1	1140

**Lane Saturation Flows**

Junction: Sandhurst Road								
Lane	Lane Width (m)	Gradient	Nearside Lane	Allowed Turns	Turning Radius (m)	Turning Prop.	Sat Flow (PCU/Hr)	Flared Sat Flow (PCU/Hr)
1/1	3.50	0.00	Y	Arm 5 Left	10.00	100.0 %	1709	1709
1/2	3.50	0.00	Y	Arm 6 Right	15.00	100.0 %	1786	1786
2/1	3.50	0.00	Y	Arm 6 Ahead	Inf	100.0 %	1965	1965
2/2	3.50	0.00	Y	Arm 4 Right	15.00	100.0 %	1786	1786
3/1	3.50	0.00	Y	Arm 4 Left	10.00	100.0 %	1709	1709
3/2	3.50	0.00	Y	Arm 5 Ahead	Inf	100.0 %	1965	1965
4/1	Infinite Saturation Flow						Inf	Inf
5/1	Infinite Saturation Flow						Inf	Inf
6/1	Infinite Saturation Flow						Inf	Inf

**Scenario 2: 'Option 1 PM Demand'** (FG2: 'Option 1 PM Demand', Plan 1: 'Network Control Plan 1')

**Traffic Flows, Desired**

**Desired Flow :**

	Destination				
		A	B	C	Tot.
Origin	A	0	103	1015	1118
	B	191	0	506	697
	C	820	517	0	1337
	Tot.	1011	620	1521	3152



Full Input Data And Results

**Traffic Lane Flows**

Lane	Scenario 2: Option 1 PM Demand
<b>Junction: Sandhurst Road</b>	
1/1 (short)	506
1/2 (with short)	697(In) 191(Out)
2/1 (with short)	1337(In) 820(Out)
2/2 (short)	517
3/1 (short)	103
3/2 (with short)	1118(In) 1015(Out)
4/1	620
5/1	1521
6/1	1011

**Lane Saturation Flows**

<b>Junction: Sandhurst Road</b>								
Lane	Lane Width (m)	Gradient	Nearside Lane	Allowed Turns	Turning Radius (m)	Turning Prop.	Sat Flow (PCU/Hr)	Flared Sat Flow (PCU/Hr)
1/1	3.50	0.00	Y	Arm 5 Left	10.00	100.0 %	1709	1709
1/2	3.50	0.00	Y	Arm 6 Right	15.00	100.0 %	1786	1786
2/1	3.50	0.00	Y	Arm 6 Ahead	Inf	100.0 %	1965	1965
2/2	3.50	0.00	Y	Arm 4 Right	15.00	100.0 %	1786	1786
3/1	3.50	0.00	Y	Arm 4 Left	10.00	100.0 %	1709	1709
3/2	3.50	0.00	Y	Arm 5 Ahead	Inf	100.0 %	1965	1965
4/1	Infinite Saturation Flow						Inf	Inf
5/1	Infinite Saturation Flow						Inf	Inf
6/1	Infinite Saturation Flow						Inf	Inf

**Scenario 3: 'Option 2 AM Demand'** (FG3: 'Option 2 AM Demand', Plan 1: 'Network Control Plan 1')

**Traffic Flows, Desired**

**Desired Flow :**

	Destination				
		A	B	C	Tot.
Origin	A	0	156	1010	1166
	B	121	0	752	873
	C	1034	529	0	1563
	Tot.	1155	685	1762	3602

Full Input Data And Results

**Traffic Lane Flows**

Scenario 3: Option 2 AM Demand	
<b>Junction: Sandhurst Road</b>	
1/1 (short)	752
1/2 (with short)	873(In) 121(Out)
2/1 (with short)	1563(In) 1034(Out)
2/2 (short)	529
3/1 (short)	156
3/2 (with short)	1166(In) 1010(Out)
4/1	685
5/1	1762
6/1	1155

**Lane Saturation Flows**

Junction: Sandhurst Road								
Lane	Lane Width (m)	Gradient	Nearside Lane	Allowed Turns	Turning Radius (m)	Turning Prop.	Sat Flow (PCU/Hr)	Flared Sat Flow (PCU/Hr)
1/1	3.50	0.00	Y	Arm 5 Left	10.00	100.0 %	1709	1709
1/2	3.50	0.00	Y	Arm 6 Right	15.00	100.0 %	1786	1786
2/1	3.50	0.00	Y	Arm 6 Ahead	Inf	100.0 %	1965	1965
2/2	3.50	0.00	Y	Arm 4 Right	15.00	100.0 %	1786	1786
3/1	3.50	0.00	Y	Arm 4 Left	10.00	100.0 %	1709	1709
3/2	3.50	0.00	Y	Arm 5 Ahead	Inf	100.0 %	1965	1965
4/1	Infinite Saturation Flow						Inf	Inf
5/1	Infinite Saturation Flow						Inf	Inf
6/1	Infinite Saturation Flow						Inf	Inf

**Scenario 4: 'Option 2 PM Demand'** (FG4: 'Option 2 PM Demand', Plan 1: 'Network Control Plan 1')

**Traffic Flows, Desired**

**Desired Flow :**

	Destination				
		A	B	C	Tot.
Origin	A	0	103	1024	1127
	B	131	0	617	748
	C	872	523	0	1395
	Tot.	1003	626	1641	3270

Full Input Data And Results

**Traffic Lane Flows**

Scenario 4: Option 2 PM Demand	
<b>Junction: Sandhurst Road</b>	
1/1 (short)	617
1/2 (with short)	748(In) 131(Out)
2/1 (with short)	1395(In) 872(Out)
2/2 (short)	523
3/1 (short)	103
3/2 (with short)	1127(In) 1024(Out)
4/1	626
5/1	1641
6/1	1003

**Lane Saturation Flows**

Junction: Sandhurst Road								
Lane	Lane Width (m)	Gradient	Nearside Lane	Allowed Turns	Turning Radius (m)	Turning Prop.	Sat Flow (PCU/Hr)	Flared Sat Flow (PCU/Hr)
1/1	3.50	0.00	Y	Arm 5 Left	10.00	100.0 %	1709	1709
1/2	3.50	0.00	Y	Arm 6 Right	15.00	100.0 %	1786	1786
2/1	3.50	0.00	Y	Arm 6 Ahead	Inf	100.0 %	1965	1965
2/2	3.50	0.00	Y	Arm 4 Right	15.00	100.0 %	1786	1786
3/1	3.50	0.00	Y	Arm 4 Left	10.00	100.0 %	1709	1709
3/2	3.50	0.00	Y	Arm 5 Ahead	Inf	100.0 %	1965	1965
4/1	Infinite Saturation Flow						Inf	Inf
5/1	Infinite Saturation Flow						Inf	Inf
6/1	Infinite Saturation Flow						Inf	Inf

**Scenario 1: 'Option 1 AM Demand' (FG1: 'Option 1 AM Demand', Plan 1: 'Network Control Plan 1')**

**Stage Sequence Diagram**

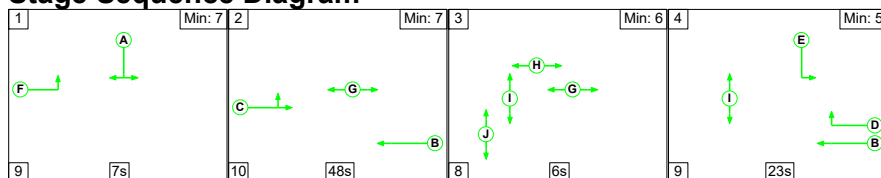

**Stage Timings**

Stage	1	2	3	4
Duration	7	48	6	23
Change Point	0	16	74	88

Signal Timings Diagram

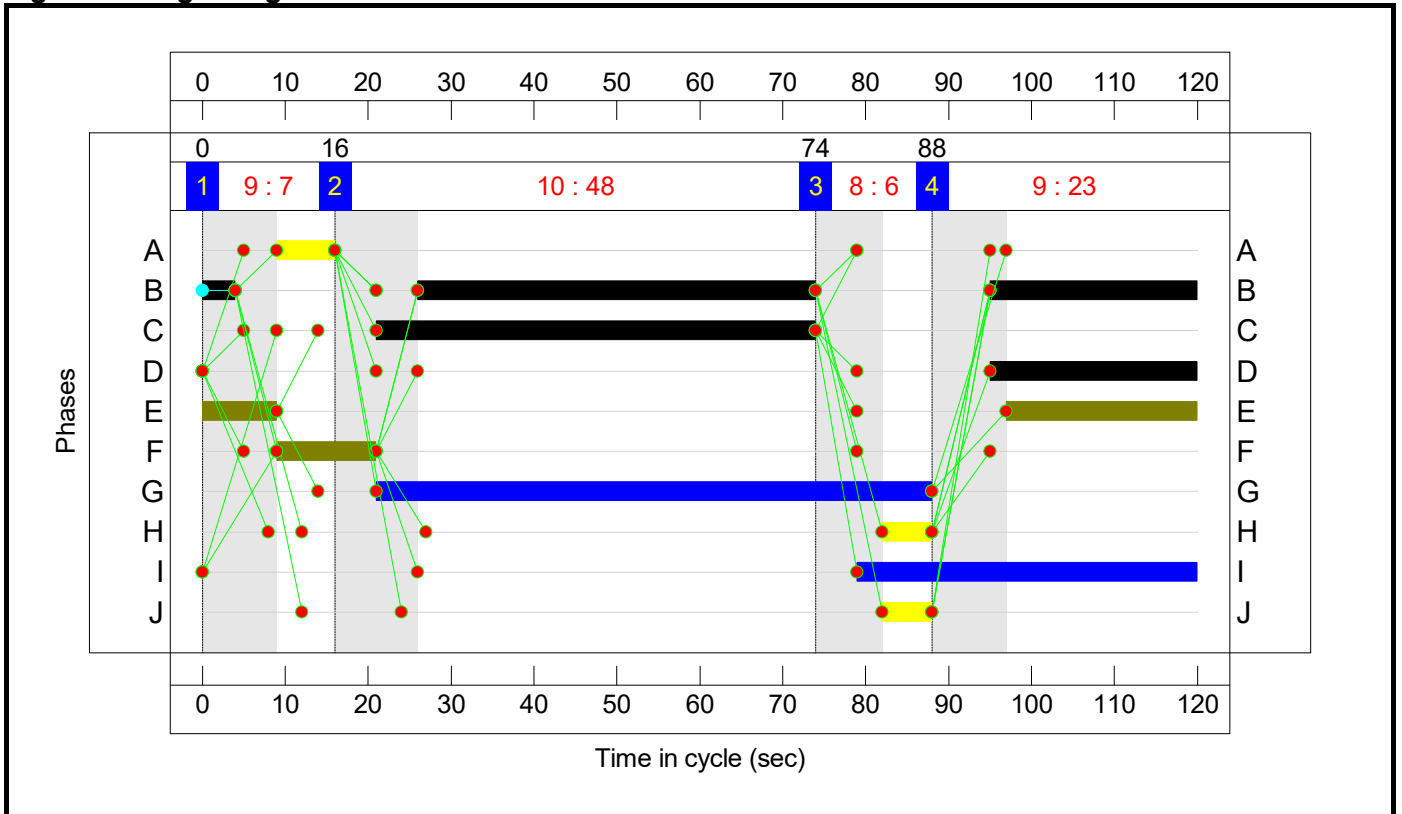

Full Input Data And Results  
**Network Layout Diagram**

Full Input Data And Results

 **Sandhurst Road**  
PRC: -46.7 %  
Total Traffic Delay: 481.1 pcuHr

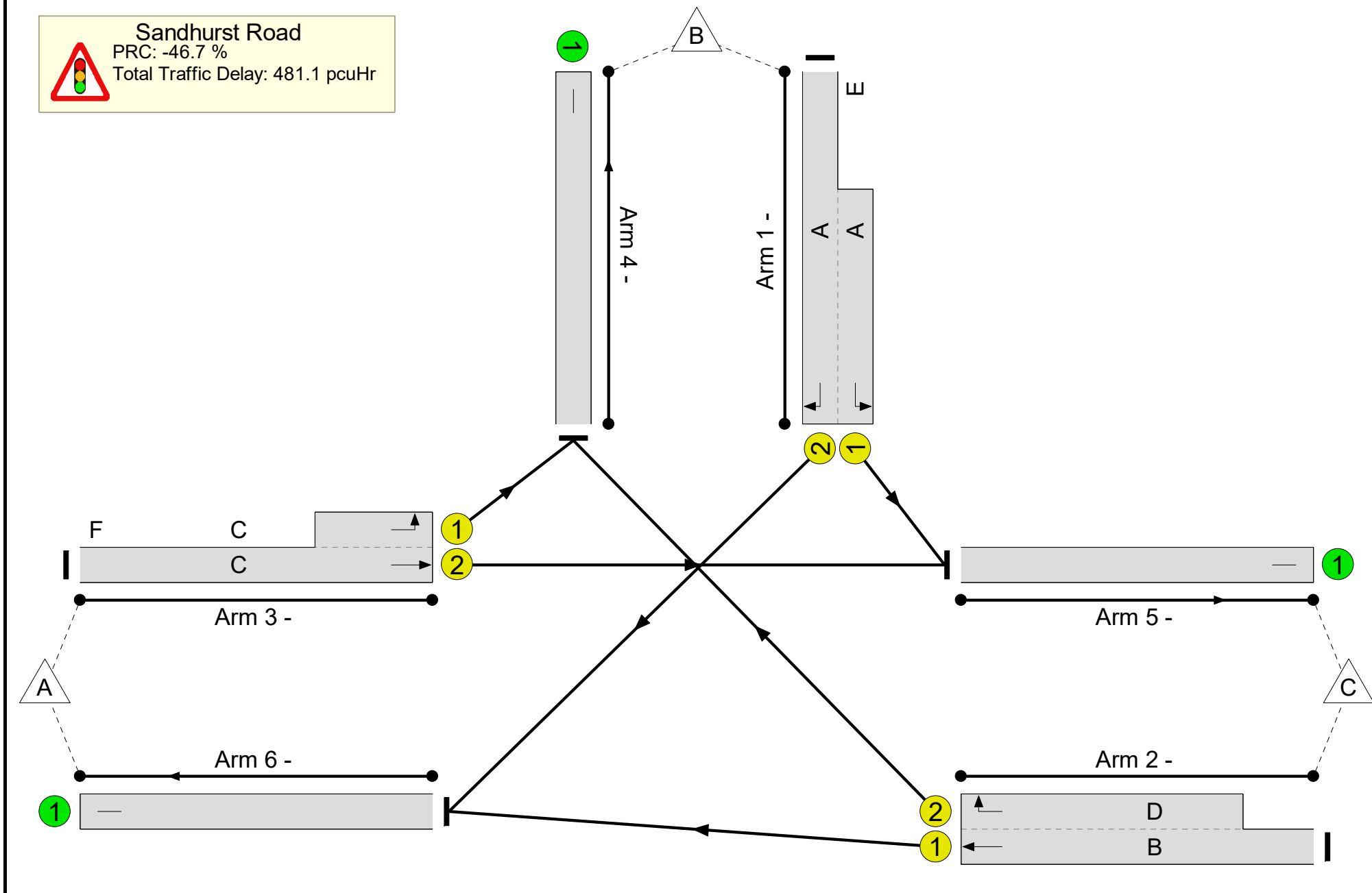

Full Input Data And Results

Network Results

Item	Lane Description	Lane Type	Controller Stream	Position In Filtered Route	Full Phase	Arrow Phase	Num Greens	Total Green (s)	Arrow Green (s)	Demand Flow (pcu)	Sat Flow (pcu/Hr)	Capacity (pcu)	Deg Sat (%)
Network	-	-	N/A	-	-		-	-	-	-	-	-	132.1%
Sandhurst Road	-	-	N/A	-	-		-	-	-	-	-	-	132.1%
1/2+1/1	Left Right	U	N/A	N/A	A	E	1	7:39	32	779	1786:1709	94+531	124.6 : 124.6%
2/1+2/2	Right Ahead	U	N/A	N/A	B D		2:1	77:25	-	1534	1965:1786	775+387	132.1 : 132.1%
3/2+3/1	Left Ahead	U	N/A	N/A	C	F	1	53:65	12	1181	1965:1709	761+137	131.6 : 131.6%
4/1		U	N/A	N/A	-		-	-	-	691	Inf	Inf	0.0%
5/1		U	N/A	N/A	-		-	-	-	1663	Inf	Inf	0.0%
6/1		U	N/A	N/A	-		-	-	-	1140	Inf	Inf	0.0%
Item	Arriving (pcu)	Leaving (pcu)	Turners In Gaps (pcu)	Turners When Unopposed (pcu)	Turners In Intergreen (pcu)	Uniform Delay (pcuHr)	Rand + Oversat Delay (pcuHr)	Storage Area Uniform Delay (pcuHr)	Total Delay (pcuHr)	Av. Delay Per PCU (s/pcu)	Max. Back of Uniform Queue (pcu)	Rand + Oversat Queue (pcu)	Mean Max Queue (pcu)
Network	-	-	0	0	0	69.7	411.3	0.0	481.1	-	-	-	-
Sandhurst Road	-	-	0	0	0	69.7	411.3	0.0	481.1	-	-	-	-
1/2+1/1	779	625	-	-	-	19.2	79.3	-	98.5	455.1	31.7	79.3	111.0
2/1+2/2	1534	1162	-	-	-	25.0	188.2	-	213.2	500.3	47.3	188.2	235.5
3/2+3/1	1181	897	-	-	-	25.6	143.9	-	169.4	516.4	49.2	143.9	193.1
4/1	524	524	-	-	-	0.0	0.0	-	0.0	0.0	0.0	0.0	0.0
5/1	1292	1292	-	-	-	0.0	0.0	-	0.0	0.0	0.0	0.0	0.0
6/1	869	869	-	-	-	0.0	0.0	-	0.0	0.0	0.0	0.0	0.0
C1			PRC for Signalled Lanes (%): -46.7		PRC Over All Lanes (%): -46.7		Total Delay for Signalled Lanes (pcuHr): 481.07		Total Delay Over All Lanes(pcuHr): 481.07		Cycle Time (s): 120		

Full Input Data And Results

Scenario 2: 'Option 1 PM Demand' (FG2: 'Option 1 PM Demand', Plan 1: 'Network Control Plan 1')

Stage Sequence Diagram

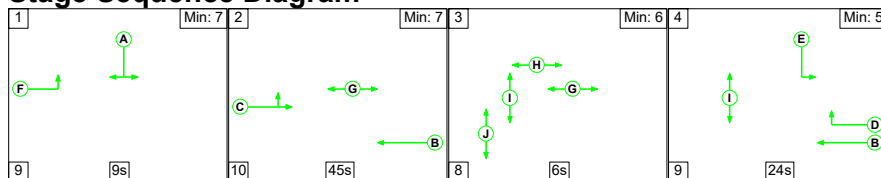

Stage Timings

Stage	1	2	3	4
Duration	9	45	6	24
Change Point	0	18	73	87

Signal Timings Diagram

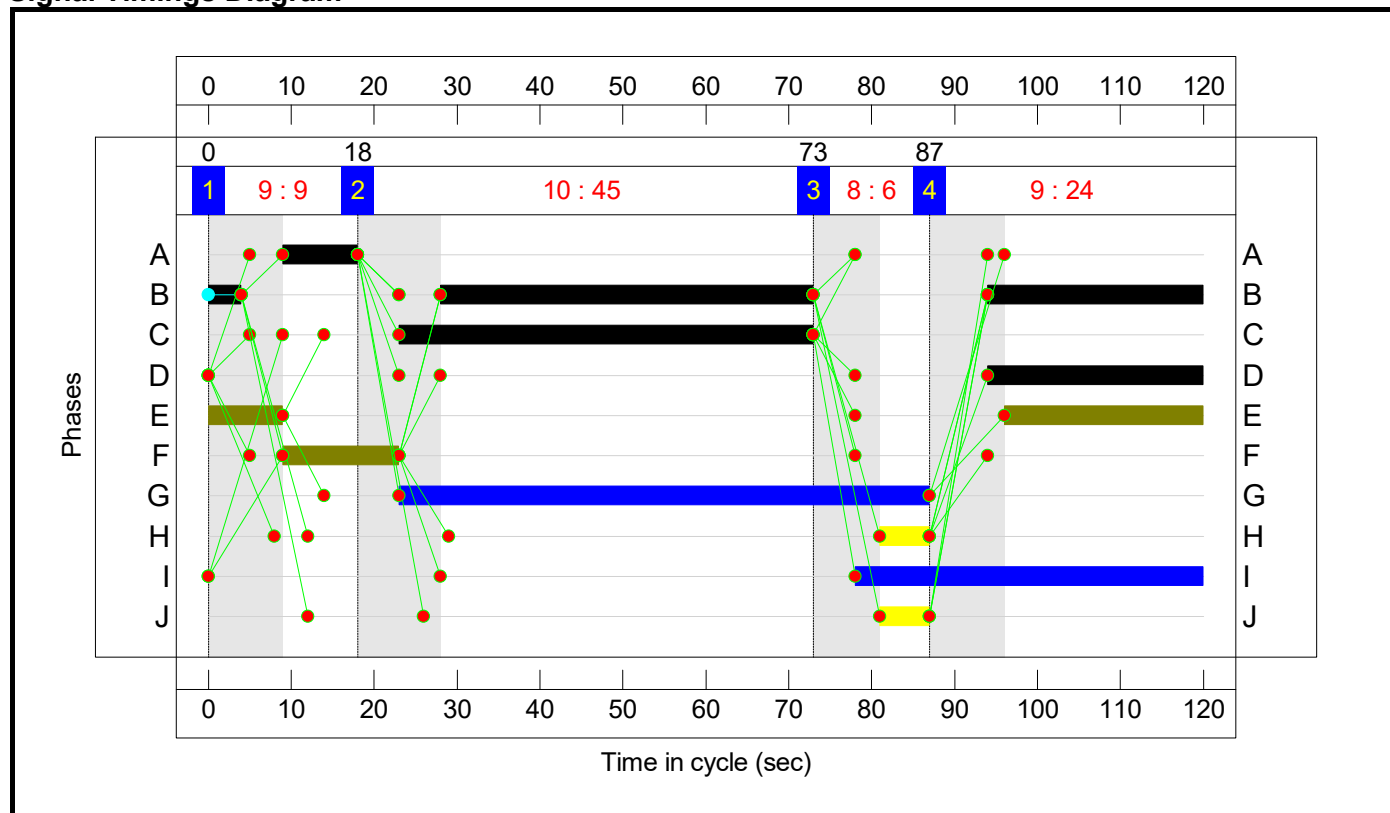



Full Input Data And Results  
**Network Layout Diagram**

Full Input Data And Results

 **Sandhurst Road**  
PRC: -47.3 %  
Total Traffic Delay: 377.0 pcuHr

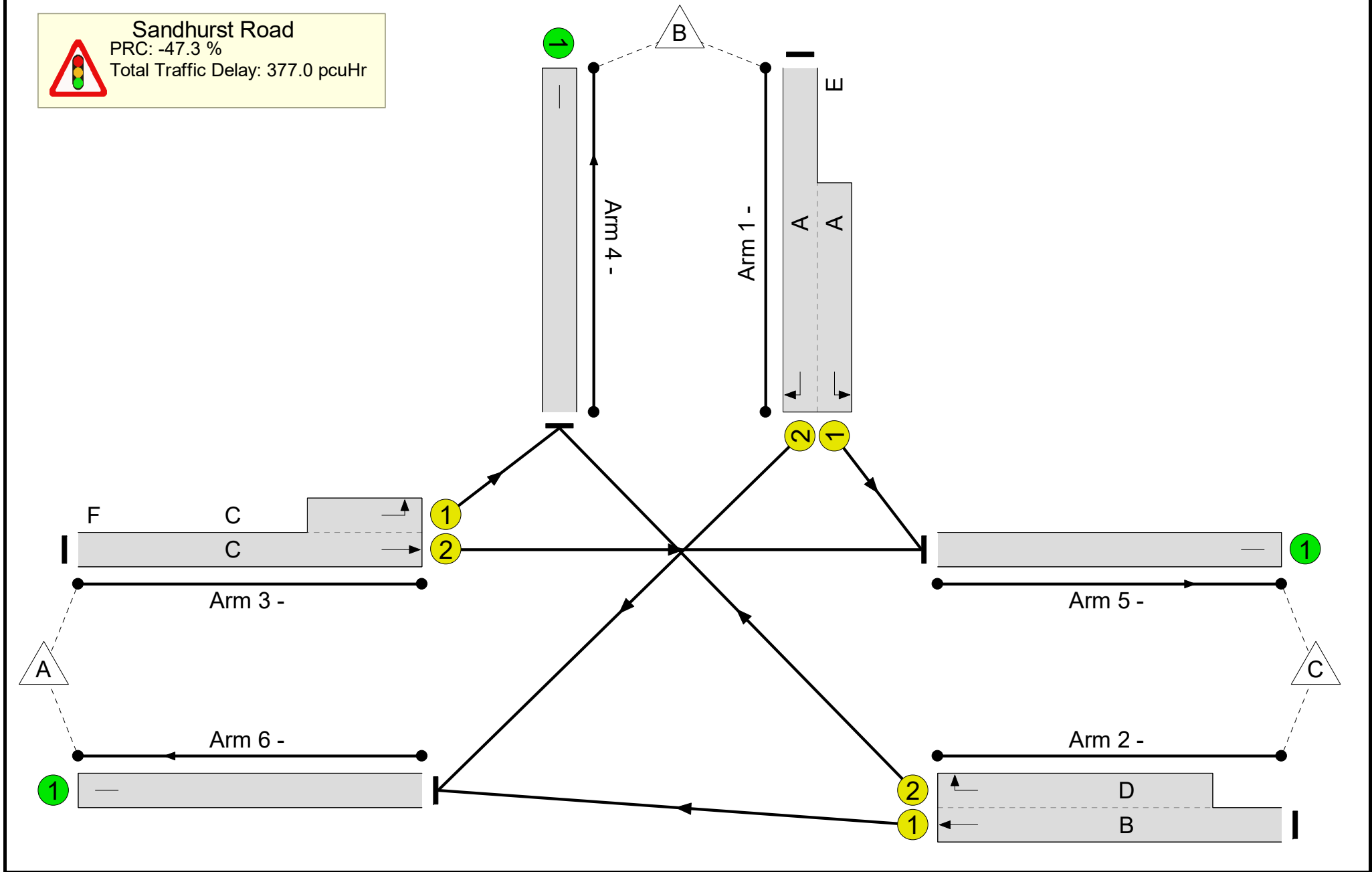

Full Input Data And Results

Network Results

Item	Lane Description	Lane Type	Controller Stream	Position In Filtered Route	Full Phase	Arrow Phase	Num Greens	Total Green (s)	Arrow Green (s)	Demand Flow (pcu)	Sat Flow (pcu/Hr)	Capacity (pcu)	Deg Sat (%)
<b>Network</b>	-	-	N/A	-	-		-	-	-	-	-	-	132.5%
<b>Sandhurst Road</b>	-	-	N/A	-	-		-	-	-	-	-	-	132.5%
1/2+1/1	Left Right	U	N/A	N/A	A	E	1	9:42	33	697	1786:1709	149+530	128.3 : 95.4%
2/1+2/2	Right Ahead	U	N/A	N/A	B D		2:1	75:26	-	1337	1965:1786	637+402	128.7 : 128.7%
3/2+3/1	Left Ahead	U	N/A	N/A	C	F	1	50:64	14	1118	1965:1709	766+78	132.5 : 132.5%
4/1		U	N/A	N/A	-		-	-	-	620	Inf	Inf	0.0%
5/1		U	N/A	N/A	-		-	-	-	1521	Inf	Inf	0.0%
6/1		U	N/A	N/A	-		-	-	-	1011	Inf	Inf	0.0%
Item	Arriving (pcu)	Leaving (pcu)	Turners In Gaps (pcu)	Turners When Unopposed (pcu)	Turners In Intergreen (pcu)	Uniform Delay (pcuHr)	Rand + Oversat Delay (pcuHr)	Storage Area Uniform Delay (pcuHr)	Total Delay (pcuHr)	Av. Delay Per PCU (s/pcu)	Max. Back of Uniform Queue (pcu)	Rand + Oversat Queue (pcu)	Mean Max Queue (pcu)
<b>Network</b>	-	-	0	0	0	56.1	320.8	0.0	377.0	-	-	-	-
<b>Sandhurst Road</b>	-	-	0	0	0	56.1	320.8	0.0	377.0	-	-	-	-
1/2+1/1	697	655	-	-	-	10.6	30.5	-	41.1	212.4	18.7	30.5	49.2
2/1+2/2	1337	1039	-	-	-	20.5	151.1	-	171.6	462.1	38.4	151.1	189.5
3/2+3/1	1118	844	-	-	-	25.0	139.2	-	164.2	528.8	47.1	139.2	186.4
4/1	480	480	-	-	-	0.0	0.0	-	0.0	0.0	0.0	0.0	0.0
5/1	1272	1272	-	-	-	0.0	0.0	-	0.0	0.0	0.0	0.0	0.0
6/1	786	786	-	-	-	0.0	0.0	-	0.0	0.0	0.0	0.0	0.0
C1			PRC for Signalled Lanes (%): -47.3		PRC Over All Lanes (%): -47.3		Total Delay for Signalled Lanes (pcuHr): 376.98		Total Delay Over All Lanes(pcuHr): 376.98		Cycle Time (s): 120		

Full Input Data And Results

Scenario 3: 'Option 2 AM Demand' (FG3: 'Option 2 AM Demand', Plan 1: 'Network Control Plan 1')

Stage Sequence Diagram

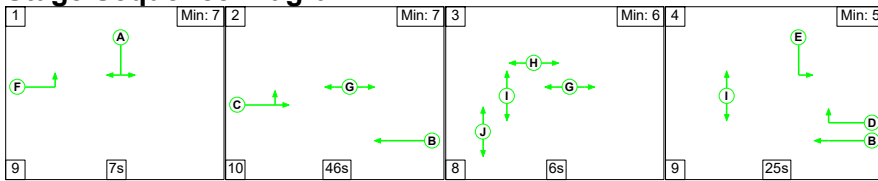

Stage Timings

Stage	1	2	3	4
Duration	7	46	6	25
Change Point	0	16	72	86

Signal Timings Diagram

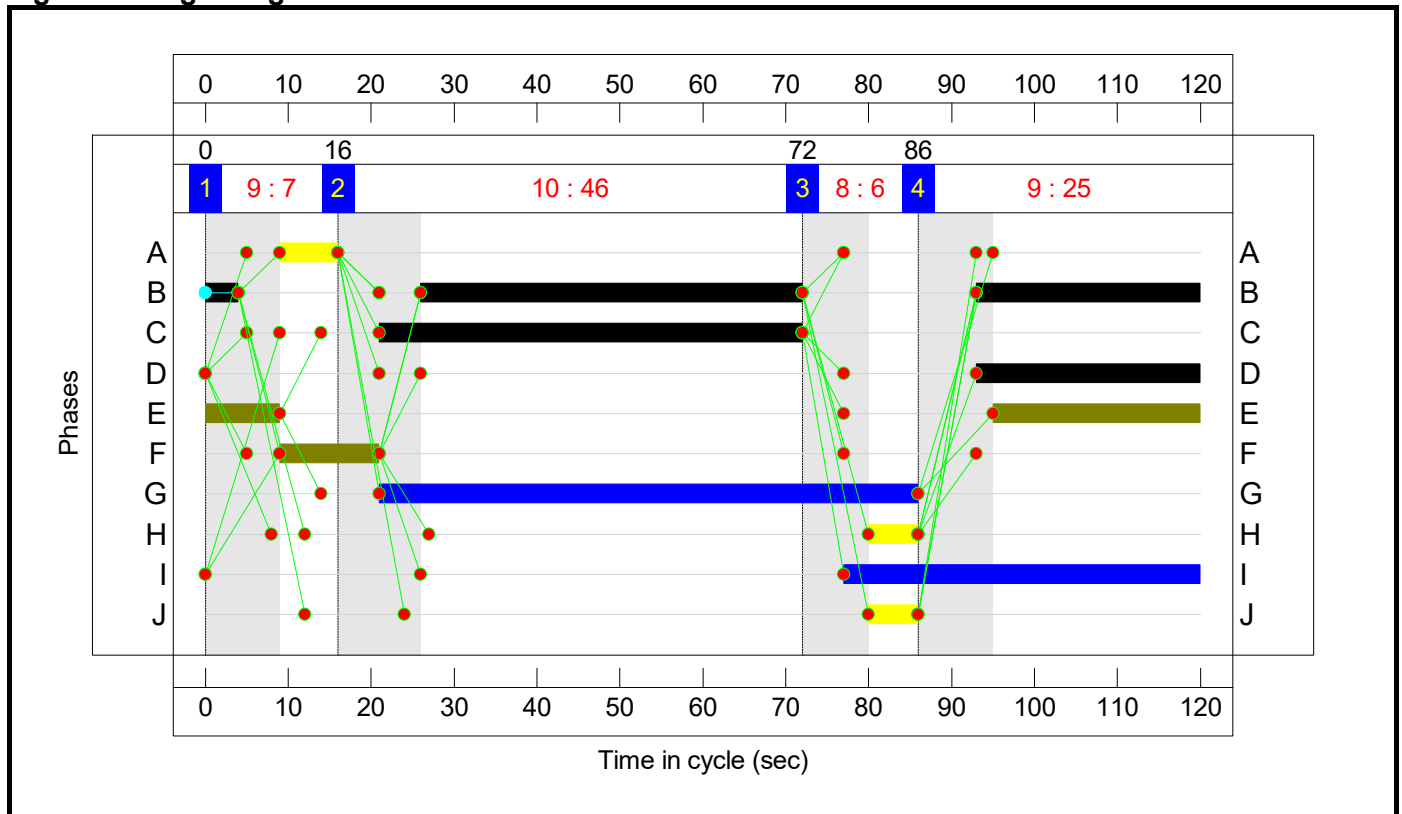

Full Input Data And Results  
**Network Layout Diagram**

Full Input Data And Results

 **Sandhurst Road**  
PRC: -50.0 %  
Total Traffic Delay: 510.7 pcuHr

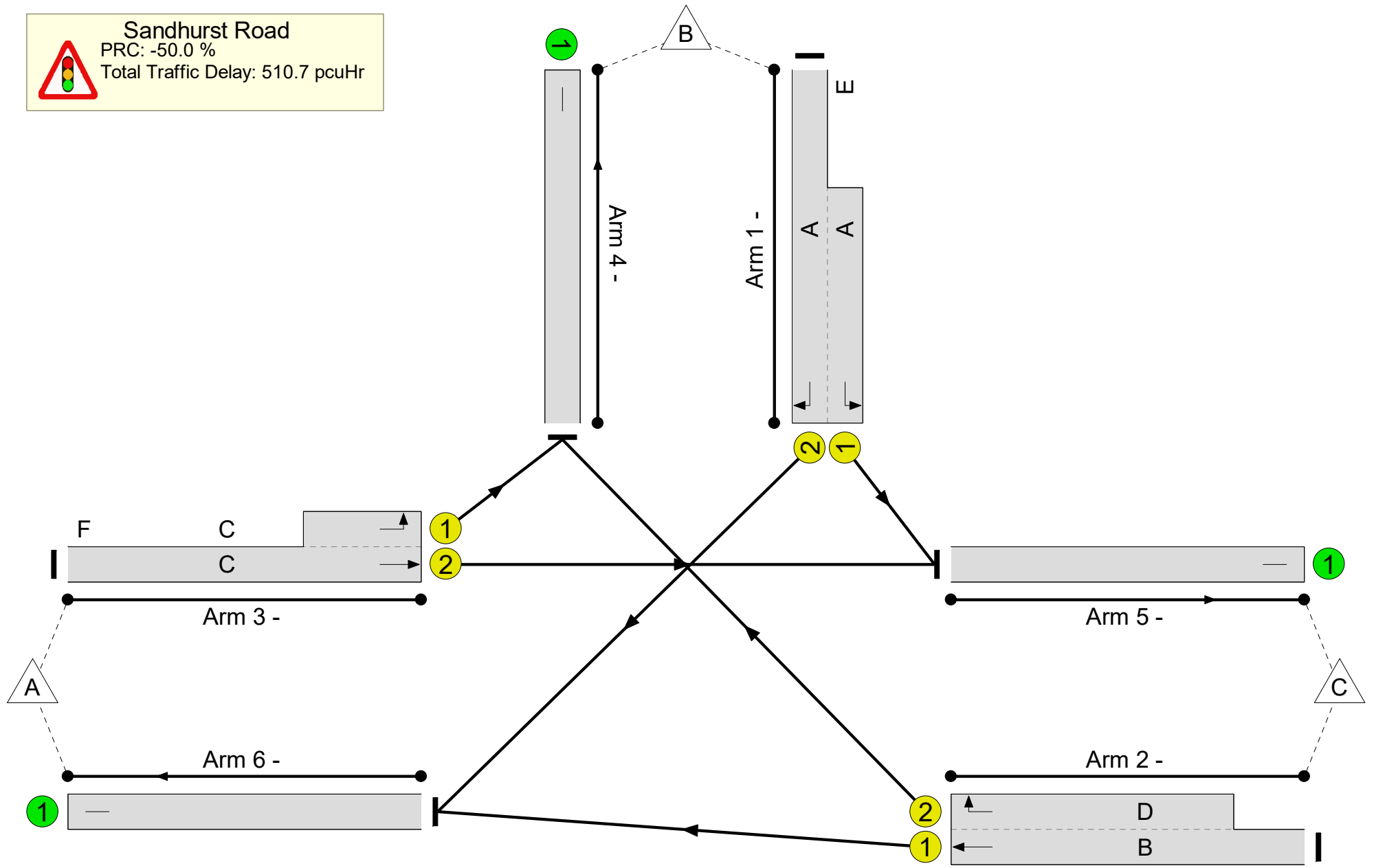

Full Input Data And Results

Network Results

Item	Lane Description	Lane Type	Controller Stream	Position In Filtered Route	Full Phase	Arrow Phase	Num Greens	Total Green (s)	Arrow Green (s)	Demand Flow (pcu)	Sat Flow (pcu/Hr)	Capacity (pcu)	Deg Sat (%)
<b>Network</b>	-	-	<b>N/A</b>	-	-		-	-	-	-	-	-	<b>135.0%</b>
<b>Sandhurst Road</b>	-	-	<b>N/A</b>	-	-		-	-	-	-	-	-	<b>135.0%</b>
1/2+1/1	Left Right	U	N/A	N/A	A	E	1	7:41	34	873	1786:1709	90+559	134.5 : 134.5%
2/1+2/2	Right Ahead	U	N/A	N/A	B D		2:1	77:27	-	1563	1965:1786	815+417	126.9 : 126.9%
3/2+3/1	Left Ahead	U	N/A	N/A	C	F	1	51:63	12	1166	1965:1709	748+116	135.0 : 135.0%
4/1		U	N/A	N/A	-		-	-	-	685	Inf	Inf	0.0%
5/1		U	N/A	N/A	-		-	-	-	1762	Inf	Inf	0.0%
6/1		U	N/A	N/A	-		-	-	-	1155	Inf	Inf	0.0%
Item	Arriving (pcu)	Leaving (pcu)	Turners In Gaps (pcu)	Turners When Unopposed (pcu)	Turners In Intergreen (pcu)	Uniform Delay (pcuHr)	Rand + Oversat Delay (pcuHr)	Storage Area Uniform Delay (pcuHr)	Total Delay (pcuHr)	Av. Delay Per PCU (s/pcu)	Max. Back of Uniform Queue (pcu)	Rand + Oversat Queue (pcu)	Mean Max Queue (pcu)
<b>Network</b>	-	-	<b>0</b>	<b>0</b>	<b>0</b>	<b>75.5</b>	<b>435.2</b>	<b>0.0</b>	<b>510.7</b>	-	-	-	-
<b>Sandhurst Road</b>	-	-	<b>0</b>	<b>0</b>	<b>0</b>	<b>75.5</b>	<b>435.2</b>	<b>0.0</b>	<b>510.7</b>	-	-	-	-
1/2+1/1	873	649	-	-	-	24.8	113.8	-	138.6	571.7	38.0	113.8	151.9
2/1+2/2	1563	1231	-	-	-	23.8	168.2	-	192.0	442.2	46.3	168.2	214.5
3/2+3/1	1166	863	-	-	-	26.9	153.2	-	180.0	555.9	49.5	153.2	202.6
4/1	532	532	-	-	-	0.0	0.0	-	0.0	0.0	0.0	0.0	0.0
5/1	1307	1307	-	-	-	0.0	0.0	-	0.0	0.0	0.0	0.0	0.0
6/1	905	905	-	-	-	0.0	0.0	-	0.0	0.0	0.0	0.0	0.0
C1			PRC for Signalled Lanes (%): -50.0		PRC Over All Lanes (%): -50.0		Total Delay for Signalled Lanes (pcuHr): 510.69		Total Delay Over All Lanes(pcuHr): 510.69		Cycle Time (s): 120		

Full Input Data And Results

Scenario 4: 'Option 2 PM Demand' (FG4: 'Option 2 PM Demand', Plan 1: 'Network Control Plan 1')

Stage Sequence Diagram

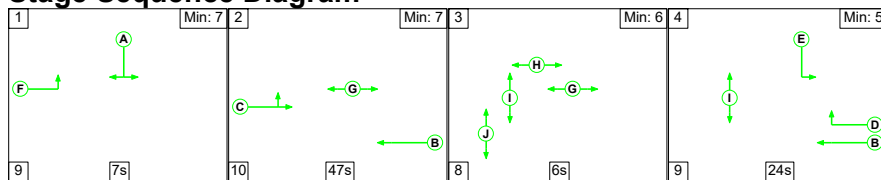

Stage Timings

Stage	1	2	3	4
Duration	7	47	6	24
Change Point	0	16	73	87

Signal Timings Diagram

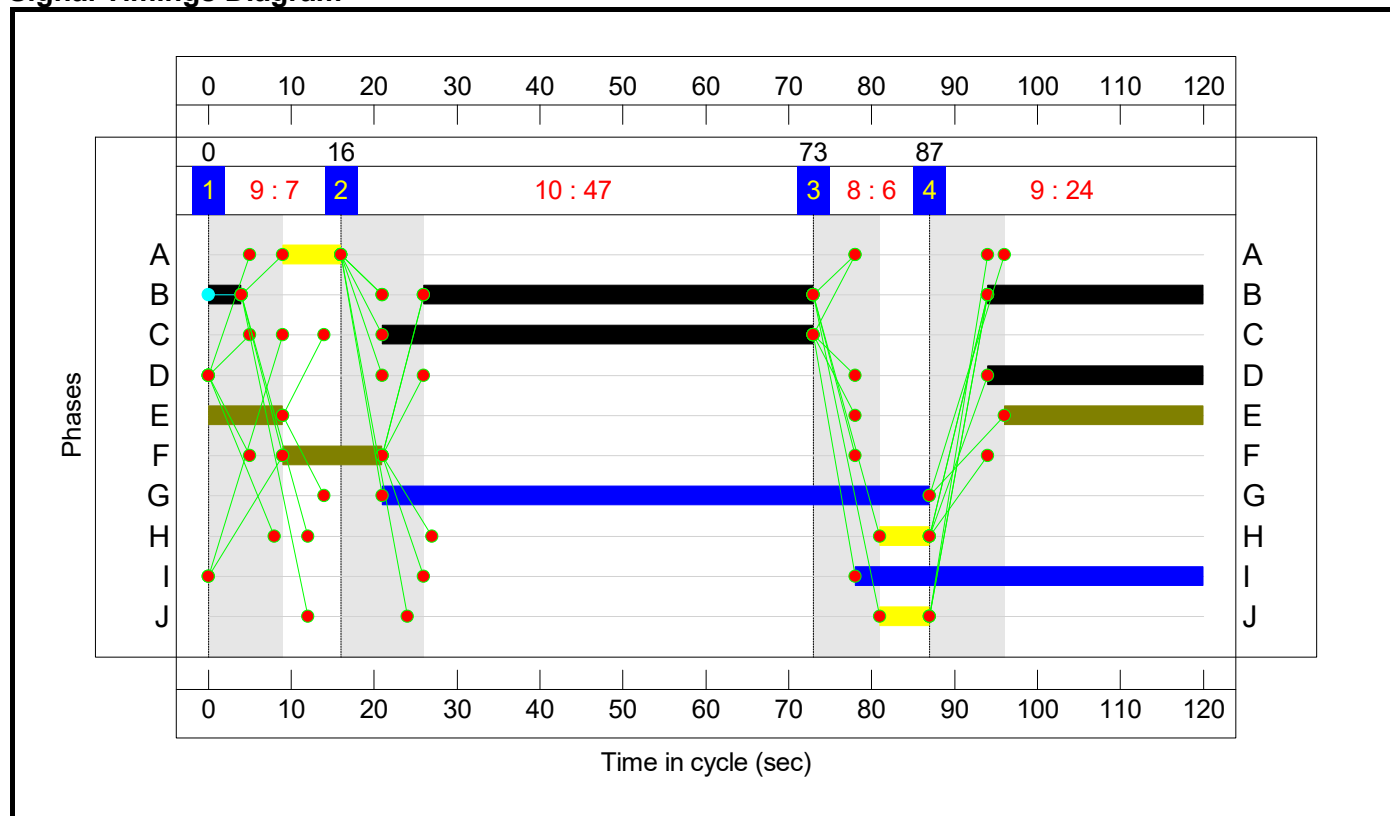



Full Input Data And Results  
**Network Layout Diagram**

Full Input Data And Results

 **Sandhurst Road**  
PRC: -44.6 %  
Total Traffic Delay: 404.5 pcuHr

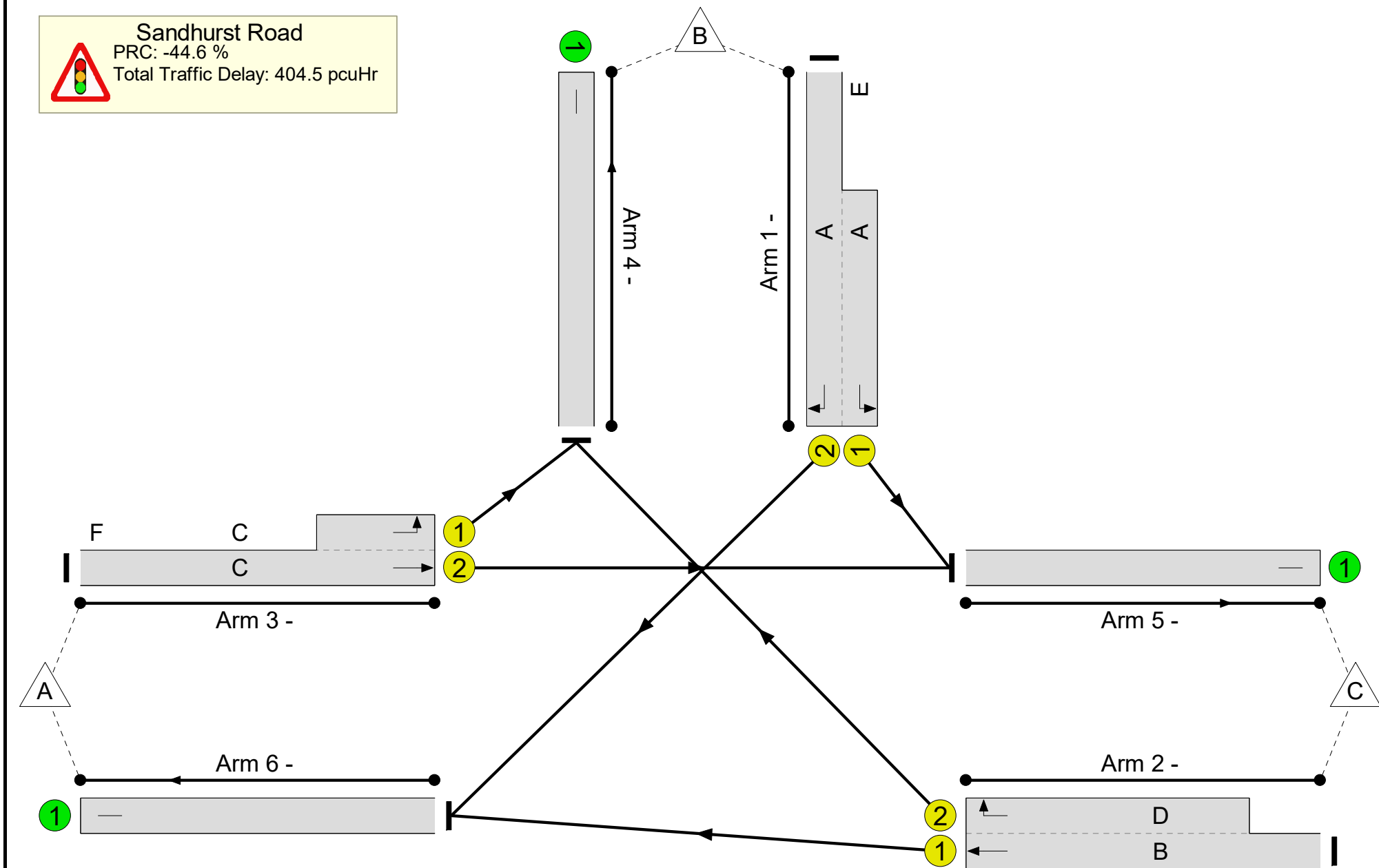

Full Input Data And Results

Network Results

Item	Lane Description	Lane Type	Controller Stream	Position In Filtered Route	Full Phase	Arrow Phase	Num Greens	Total Green (s)	Arrow Green (s)	Demand Flow (pcu)	Sat Flow (pcu/Hr)	Capacity (pcu)	Deg Sat (%)
<b>Network</b>	-	-	N/A	-	-		-	-	-	-	-	-	130.1%
<b>Sandhurst Road</b>	-	-	N/A	-	-		-	-	-	-	-	-	130.1%
1/2+1/1	Left Right	U	N/A	N/A	A	E	1	7:40	33	748	1786:1709	114+537	115.0 : 115.0%
2/1+2/2	Right Ahead	U	N/A	N/A	B D		2:1	77:26	-	1395	1965:1786	670+402	130.1 : 130.1%
3/2+3/1	Left Ahead	U	N/A	N/A	C	F	1	52:64	12	1127	1965:1709	796+80	128.7 : 128.7%
4/1		U	N/A	N/A	-		-	-	-	626	Inf	Inf	0.0%
5/1		U	N/A	N/A	-		-	-	-	1641	Inf	Inf	0.0%
6/1		U	N/A	N/A	-		-	-	-	1003	Inf	Inf	0.0%
Item	Arriving (pcu)	Leaving (pcu)	Turners In Gaps (pcu)	Turners When Unopposed (pcu)	Turners In Intergreen (pcu)	Uniform Delay (pcuHr)	Rand + Oversat Delay (pcuHr)	Storage Area Uniform Delay (pcuHr)	Total Delay (pcuHr)	Av. Delay Per PCU (s/pcu)	Max. Back of Uniform Queue (pcu)	Rand + Oversat Queue (pcu)	Mean Max Queue (pcu)
<b>Network</b>	-	-	0	0	0	60.8	343.7	0.0	404.5	-	-	-	-
<b>Sandhurst Road</b>	-	-	0	0	0	60.8	343.7	0.0	404.5	-	-	-	-
1/2+1/1	748	651	-	-	-	15.1	52.2	-	67.3	324.0	28.3	52.2	80.6
2/1+2/2	1395	1072	-	-	-	22.1	163.7	-	185.8	479.4	42.2	163.7	205.9
3/2+3/1	1127	876	-	-	-	23.7	127.8	-	151.4	483.7	46.7	127.8	174.5
4/1	482	482	-	-	-	0.0	0.0	-	0.0	0.0	0.0	0.0	0.0
5/1	1333	1333	-	-	-	0.0	0.0	-	0.0	0.0	0.0	0.0	0.0
6/1	784	784	-	-	-	0.0	0.0	-	0.0	0.0	0.0	0.0	0.0
C1			PRC for Signalled Lanes (%): -44.6		PRC Over All Lanes (%): -44.6		Total Delay for Signalled Lanes (pcuHr): 404.50		Total Delay Over All Lanes(pcuHr): 404.50		Cycle Time (s): 120		

**Appendix Q**  
**Maidstone Road Junction Existing Layout Modelling Results**  
**(Junctions10)**

Junctions 10
PICADY 10 - Priority Intersection Module
Version: 10.1.1.1905 © Copyright TRL Software Limited, 2023
For sales and distribution information, program advice and maintenance, contact TRL Software: +44 (0)1344 379777 software@trl.co.uk trlsoftware.com
The users of this computer program for the solution of an engineering problem are in no way relieved of their responsibility for the correctness of the solution

**Filename:** Pembury Road\_Maidstone Road (Existing Layout).j10  
**Path:** J:\332611481 - GH - Tunbridge Wells Local Plan\BRIEF 100 - Pembury Road\MODELLING\TRANSPORT\03. JUNCTIONS 10  
**Report generation date:** 26/06/2024 11:26:39

- »Option 1 Demand, AM
- »Option 1 Demand, PM
- »Option 2 Demand, AM
- »Option 2 Demand, PM

**Summary of junction performance**

	AM				PM			
	Q (PCU)	Delay (s)	RFC	Junction Delay (s)	Q (PCU)	Delay (s)	RFC	Junction Delay (s)
<b>Option 1 Demand</b>								
1 - Junction Access - Stream B-CD	0.2	16.08	0.17	0.91	0.1	12.48	0.13	0.82
1 - Junction Access - Stream B-AD	0.2	15.29	0.16		0.1	12.03	0.13	
1 - Junction Access - Stream A-D	0.0	0.00	0.00		0.0	0.00	0.00	
1 - Junction Access - Stream D-ABC	0.0	0.00	0.00		0.0	0.00	0.00	
1 - Junction Access - Stream C-ABD	0.0	0.00	0.00		0.0	0.00	0.00	
2 - Right Turn Bay Give Way - Stream B-AC	0.0	0.00	0.00	0.00	0.0	0.00	0.00	0.00
2 - Right Turn Bay Give Way - Stream C-AB	0.0	0.00	0.00	0.0	0.00	0.00		
3 - Eastbound Give Way - Stream B-AC	0.2	7.77	0.16	0.65	0.2	8.30	0.17	0.56
3 - Eastbound Give Way - Stream C-B	0.0	0.00	0.00		0.0	0.00	0.00	
<b>Option 2 Demand</b>								
1 - Junction Access - Stream B-CD	0.2	16.42	0.15	0.77	0.1	11.69	0.08	0.50
1 - Junction Access - Stream B-AD	0.2	15.72	0.14		0.1	11.44	0.08	
1 - Junction Access - Stream A-D	0.0	0.00	0.00		0.0	0.00	0.00	
1 - Junction Access - Stream D-ABC	0.0	0.00	0.00		0.0	0.00	0.00	
1 - Junction Access - Stream C-ABD	0.0	0.00	0.00		0.0	0.00	0.00	
2 - Right Turn Bay Give Way - Stream B-AC	0.0	0.00	0.00	0.00	0.0	0.00	0.00	0.00
2 - Right Turn Bay Give Way - Stream C-AB	0.0	0.00	0.00	0.0	0.00	0.00		
3 - Eastbound Give Way - Stream B-AC	0.2	7.62	0.14	0.53	0.1	8.16	0.11	0.32
3 - Eastbound Give Way - Stream C-B	0.0	0.00	0.00		0.0	0.00	0.00	

There are warnings associated with one or more model runs - see the 'Data Errors and Warnings' tables for each Analysis or Demand Set.

Values shown are the highest values encountered over all time segments. Delay is the maximum value of Av. delay per arriving vehicle. Junction LOS and Junction Delay are demand-weighted Av.s.

## File summary

### File Description

Title	
Location	
Site number	
Date	25/06/2024
Version	
Status	(new file)
Identifier	
Client	
Jobnumber	
Enumerator	CORP\dansmith
Description	

## Units

Distance units	Speed units	Traffic units input	Traffic units results	Flow units	Av. delay units	Total delay units	Rate of delay units
m	kph	PCU	PCU	perHour	s	-Min	perMin



The junction diagram reflects the last run of Junctions.

### Analysis Options

Vehicle length (m)	Calculate Q Percentiles	Calculate detailed queueing delay	Show lane queues in feet / metres	Show all PICADY stream intercepts	Calculate residual capacity	RFC Threshold	Av. Delay threshold (s)	Q threshold (PCU)	Use simulation for HCM roundabouts	Use iterations for HCM roundabouts
5.75						0.85	36.00	20.00		

### Demand Set Summary

ID	Scenario name	Time Period name	Traffic profile type	Start time (HH:mm)	Finish time (HH:mm)	Time segment length (min)	Run automatically
D1	Option 1 Demand	AM	ONE HOUR	00:00	01:30	15	✓
D2	Option 1 Demand	PM	ONE HOUR	00:00	01:30	15	✓
D3	Option 2 Demand	AM	ONE HOUR	00:00	01:30	15	✓
D4	Option 2 Demand	PM	ONE HOUR	00:00	01:30	15	✓

### Analysis Set Details

ID	Include in report	Network flow scaling factor (%)	Network capacity scaling factor (%)
A1	✓	100.000	100.000

# Option 1 Demand, AM

## Data Errors and Warnings

Severity	Area	Item	Description
Warning	Vehicle Mix	1 - Junction Access	HV% is zero for all movements / time segments. Vehicle Mix matrix should be completed whether working in PCUs or Vehs. If HV% at the junction is genuinely zero, please ignore this warning.
Warning	Vehicle Mix	2 - Right Turn Bay Give Way	HV% is zero for all movements / time segments. Vehicle Mix matrix should be completed whether working in PCUs or Vehs. If HV% at the junction is genuinely zero, please ignore this warning.
Warning	Vehicle Mix	3 - Eastbound Give Way	HV% is zero for all movements / time segments. Vehicle Mix matrix should be completed whether working in PCUs or Vehs. If HV% at the junction is genuinely zero, please ignore this warning.

## Junction Network

### Junctions

Junction	Name	Junction type	Arm A Direction	Arm B Direction	Arm C Direction	Arm D Direction	Use circulating lanes	Junction Delay (s)	Junction LOS
1	Junction Access	Crossroads	Entry Only	Two-way	Exit Only	Two-way		0.91	A
2	Right Turn Bay Give Way	T-Junction	Two-way	Entry Only	Exit Only			0.00	A
3	Eastbound Give Way	T-Junction	Exit Only	Entry Only	Entry Only			0.65	A

### Junction Network

Driving side	Lighting	Network delay (s)	Network LOS
Left	Normal/unknown	0.77	A

## Arms

### Arms

Junction	Arm	Name	Description	Arm type
1 - Junction Access	A	Pembury Road WB Entry		Major
	B	Maidstone Road Junction Give Way		Minor
	C	Pembury Road WB Exit		Major
	D	Pembury Road EB Right Turn Bay		Minor
2 - Right Turn Bay Give Way	A	Maidstone Road Right Turn Storage Entry		Major
	B	Pembury Road EB Right Turn Bay		Minor
	C	Maidstone Road Right Turn Storage Exit		Major
3 - Eastbound Give Way	A	Pembury Road EB Exit		Major
	B	Maidstone Road Second Give Way		Minor
	C	Pembury Road EB Entry		Major

### Major Arm Geometry

Junction	Arm	Width of carriageway (m)	Has kerbed central reserve	Has right-turn storage	Visibility for right turn (m)	Blocks?	Blocking queue (PCU)
1 - Junction Access	A - Pembury Road WB Entry	4.45			0.0		-
	C - Pembury Road WB Exit	4.45				✓	
2 - Right Turn Bay Give Way	C - Maidstone Road Right Turn Storage Exit	16.50				✓	
3 - Eastbound Give Way	C - Pembury Road EB Entry	4.61			0.0		-

Geometries for Arm C are measured opposite Arm B. Geometries for Arm A (if relevant) are measured opposite Arm D.



### Minor Arm Geometry

Junction	Arm	Minor arm type	Lane width (m)	Width at give-way (m)	Width at 5m (m)	Width at 10m (m)	Width at 15m (m)	Width at 20m (m)	Estimate flare length	Flare length (PCU)	Visibility to left (m)	Visibility to right (m)
1 - Junction Access	B - Maidstone Road Junction Give Way	One lane plus flare		10.00	10.00	8.21	5.71	4.87	✓	3.00	120	90
	D - Pembury Road EB Right Turn Bay	One lane	4.28								20	34
2 - Right Turn Bay Give Way	B - Pembury Road EB Right Turn Bay	One lane	4.28								20	34
3 - Eastbound Give Way	B - Maidstone Road Second Give Way	One lane	5.00								250	107

### Slope / Intercept / Capacity

#### Priority Intersection Slopes and Intercepts

Junction	Stream	Intercept (PCU/hr)	Slope for A-B	Slope for A-C	Slope for A-D	Slope for B-A	Slope for B-C	Slope for B-D	Slope for C-A	Slope for C-B	Slope for C-D	Slope for D-A	Slope for D-B	Slope for D-C
1 - Junction Access	A-D	574	-	-	-	-	-	-	0.194	0.278	0.194	-	-	-
	B-A	612	0.097	0.246	0.246	-	-	-	0.155	0.352	-	0.246	0.246	0.123
	B-C	741	0.099	0.251	-	-	-	-	-	-	-	-	-	-
	B-D, nearside lane	612	0.097	0.246	0.246	-	-	-	0.155	0.352	0.155	-	-	-
	B-D, offside lane	612	0.097	0.246	0.246	-	-	-	0.155	0.352	0.155	-	-	-
	C-B	574	0.194	0.194	0.278	-	-	-	-	-	-	-	-	-
	D-A	728	-	-	-	-	-	-	0.246	-	0.097	-	-	-
	D-B, nearside lane	565	0.143	0.143	0.324	-	-	-	0.227	0.227	0.090	-	-	-
	D-B, offside lane	565	0.143	0.143	0.324	-	-	-	0.227	0.227	0.090	-	-	-
D-C	565	-	0.143	0.324	0.114	0.227	0.227	0.227	0.227	0.090	-	-	-	

#### Priority Intersection Slopes and Intercepts

Junction	Stream	Intercept (PCU/hr)	Slope for A-B	Slope for A-C	Slope for C-A	Slope for C-B
2 - Right Turn Bay Give Way	B-A	565	0.056	0.141	0.089	0.202
	B-C	728	-0.020	-0.049	-	-
	C-B	574	0.041	0.041	-	-

#### Priority Intersection Slopes and Intercepts

Junction	Stream	Intercept (PCU/hr)	Slope for A-B	Slope for A-C	Slope for C-A	Slope for C-B
3 - Eastbound Give Way	B-A	740	0.116	0.293	0.184	0.419
	B-C	829	0.135	0.341	-	-
	C-B	574	0.214	0.214	-	-

The slopes and intercepts shown above include custom intercept adjustments only.

Streams may be combined, in which case capacity will be adjusted.

Values are shown for the first time segment only; they may differ for subsequent time segments.

## Traffic Demand

### Demand Set Details

ID	Scenario name	Time Period name	Traffic profile type	Start time (HH:mm)	Finish time (HH:mm)	Time segment length (min)	Run automatically
D1	Option 1 Demand	AM	ONE HOUR	00:00	01:30	15	✓

### Demand overview (Traffic)

Junction	Arm	Linked arm	Profile type	Use O-D data	Av. Demand (PCU/hr)	Scaling Factor (%)
1 - Junction Access	A - Pembury Road WB Entry		ONE HOUR	✓	1352	100.000
	B - Maidstone Road Junction Give Way		ONE HOUR	✓	83	100.000
	C - Pembury Road WB Exit		ONE HOUR	✓	0	100.000
	D - Pembury Road EB Right Turn Bay		ONE HOUR	✓	0	100.000
2 - Right Turn Bay Give Way	A - Maidstone Road Right Turn Storage Entry		ONE HOUR	✓	83	100.000
	B - Pembury Road EB Right Turn Bay		ONE HOUR	✓	0	100.000
	C - Maidstone Road Right Turn Storage Exit		ONE HOUR	✓	0	100.000
3 - Eastbound Give Way	A - Pembury Road EB Exit		ONE HOUR	✓	0	100.000
	B - Maidstone Road Second Give Way		ONE HOUR	✓	83	100.000
	C - Pembury Road EB Entry		ONE HOUR	✓	913	100.000

### Origin-Destination Data

#### Demand (PCU/hr)

#### 1 - Junction Access

		To			
		A - Pembury Road WB Entry	B - Maidstone Road Junction Give Way	C - Pembury Road WB Exit	D - Pembury Road EB Right Turn Bay
From	A - Pembury Road WB Entry	0	217	1135	0
	B - Maidstone Road Junction Give Way	0	0	0	83
	C - Pembury Road WB Exit	0	0	0	0
	D - Pembury Road EB Right Turn Bay	0	0	0	0

#### Demand (PCU/hr)

#### 2 - Right Turn Bay Give Way

		To		
		A - Maidstone Road Right Turn Storage Entry	B - Pembury Road EB Right Turn Bay	C - Maidstone Road Right Turn Storage Exit
From	A - Maidstone Road Right Turn Storage Entry	0	0	83
	B - Pembury Road EB Right Turn Bay	0	0	0
	C - Maidstone Road Right Turn Storage Exit	0	0	0

#### Demand (PCU/hr)

#### 3 - Eastbound Give Way

		To		
		A - Pembury Road EB Exit	B - Maidstone Road Second Give Way	C - Pembury Road EB Entry
From	A - Pembury Road EB Exit	0	0	0
	B - Maidstone Road Second Give Way	83	0	0
	C - Pembury Road EB Entry	913	0	0

### Vehicle Mix

HV data entry mode	PCU Factor for a HV (PCU)
HV Percentages	2.00

Heavy Vehicle %

1 - Junction Access

		To			
		A - Pembury Road WB Entry	B - Maidstone Road Junction Give Way	C - Pembury Road WB Exit	D - Pembury Road EB Right Turn Bay
From	A - Pembury Road WB Entry	0	0	0	0
	B - Maidstone Road Junction Give Way	0	0	0	0
	C - Pembury Road WB Exit	0	0	0	0
	D - Pembury Road EB Right Turn Bay	0	0	0	0

Heavy Vehicle %

2 - Right Turn Bay Give Way

		To		
		A - Maidstone Road Right Turn Storage Entry	B - Pembury Road EB Right Turn Bay	C - Maidstone Road Right Turn Storage Exit
From	A - Maidstone Road Right Turn Storage Entry	0	0	0
	B - Pembury Road EB Right Turn Bay	0	0	0
	C - Maidstone Road Right Turn Storage Exit	0	0	0

Heavy Vehicle %

3 - Eastbound Give Way

		To		
		A - Pembury Road EB Exit	B - Maidstone Road Second Give Way	C - Pembury Road EB Entry
From	A - Pembury Road EB Exit	0	0	0
	B - Maidstone Road Second Give Way	0	0	0
	C - Pembury Road EB Entry	0	0	0

## Results

### Results Summary for whole modelled period

Junction	Stream	Max RFC	Max Delay (s)	Max Q (PCU)	Max LOS	Average Demand (PCU/hr)	Total Junction Arrivals (PCU)
1 - Junction Access	B-CD	0.17	16.08	0.2	C	38	57
	B-AD	0.16	15.29	0.2	C	38	57
	A-B					199	299
	A-C					1041	1562
	A-D	0.00	0.00	0.0	A	0	0
	D-ABC	0.00	0.00	0.0	A	0	0
	C-ABD	0.00	0.00	0.0	A	0	0
	C-D					0	0
	C-A					0	0
2 - Right Turn Bay Give Way	B-AC	0.00	0.00	0.0	A	0	0
	C-AB	0.00	0.00	0.0	A	0	0
	C-A					0	0
	A-B					0	0
	A-C					76	114
3 - Eastbound Give Way	B-AC	0.16	7.77	0.2	A	76	114
	C-A					838	1257
	C-B	0.00	0.00	0.0	A	0	0
	A-B					0	0
	A-C					0	0

### Main Results for each time segment

#### 00:00 - 00:15

Junction	Stream	Total Demand (PCU/hr)	Junction Arrivals (PCU)	Capacity (PCU/hr)	RFC	Throughput (PCU/hr)	Start queue (PCU)	End queue (PCU)	Delay (s)	Unsignalised level of service
1 - Junction Access	B-CD	31	8	378	0.083	31	0.0	0.1	10.359	B
	B-AD	31	8	386	0.081	31	0.0	0.1	10.133	B
	A-B	163	41			163				
	A-C	854	214			854				
	A-D	0	0	574	0.000	0	0.0	0.0	0.000	A
	D-ABC	0	0	472	0.000	0	0.0	0.0	0.000	A
	C-ABD	0	0	376	0.000	0	0.0	0.0	0.000	A
	C-D	0	0			0				
2 - Right Turn Bay Give Way	C-A	0	0			0				
	A-B	0	0			0				
	A-C	62	16			62				
	B-AC	0	0	632	0.000	0	0.0	0.0	0.000	A
	C-AB	0	0	571	0.000	0	0.0	0.0	0.000	A
3 - Eastbound Give Way	C-A	687	172			687				
	B-AC	62	16	613	0.102	62	0.0	0.1	6.525	A
	C-B	0	0	574	0.000	0	0.0	0.0	0.000	A
	A-B	0	0			0				
	A-C	0	0			0				

#### 00:15 - 00:30

Junction	Stream	Total Demand (PCU/hr)	Junction Arrivals (PCU)	Capacity (PCU/hr)	RFC	Throughput (PCU/hr)	Start queue (PCU)	End queue (PCU)	Delay (s)	Unsignalised level of service
1 - Junction Access	B-CD	37	9	333	0.112	37	0.1	0.1	12.181	B
	B-AD	37	9	342	0.109	37	0.1	0.1	11.807	B
	A-B	195	49			195				
	A-C	1020	255			1020				
	A-D	0	0	574	0.000	0	0.0	0.0	0.000	A
	D-ABC	0	0	446	0.000	0	0.0	0.0	0.000	A
	C-ABD	0	0	338	0.000	0	0.0	0.0	0.000	A
	C-D	0	0			0				
2 - Right Turn Bay Give Way	C-A	0	0			0				
	A-B	0	0			0				
	A-C	75	19			75				
	B-AC	0	0	631	0.000	0	0.0	0.0	0.000	A
	C-AB	0	0	571	0.000	0	0.0	0.0	0.000	A
3 - Eastbound Give Way	C-A	821	205			821				
	B-AC	75	19	589	0.127	74	0.1	0.1	6.999	A
	C-B	0	0	574	0.000	0	0.0	0.0	0.000	A
	A-B	0	0			0				
	A-C	0	0			0				

## 00:30 - 00:45

Junction	Stream	Total Demand (PCU/hr)	Junction Arrivals (PCU)	Capacity (PCU/hr)	RFC	Throughput (PCU/hr)	Start queue (PCU)	End queue (PCU)	Delay (s)	Unsignalised level of service
1 - Junction Access	B-CD	46	11	270	0.169	45	0.1	0.2	16.031	C
	B-AD	46	11	281	0.163	45	0.1	0.2	15.249	C
	A-B	239	60			239				
	A-C	1250	312			1250				
	A-D	0	0	574	0.000	0	0.0	0.0	0.000	A
	D-ABC	0	0	408	0.000	0	0.0	0.0	0.000	A
	C-ABD	0	0	285	0.000	0	0.0	0.0	0.000	A
	C-D	0	0			0				
2 - Right Turn Bay Give Way	C-A	0	0			0				
	B-AC	0	0	630	0.000	0	0.0	0.0	0.000	A
	C-AB	0	0	570	0.000	0	0.0	0.0	0.000	A
	A-B	0	0			0				
	A-C	91	23			91				
3 - Eastbound Give Way	B-AC	91	23	555	0.165	91	0.1	0.2	7.764	A
	C-A	1005	251			1005				
	C-B	0	0	574	0.000	0	0.0	0.0	0.000	A
	A-B	0	0			0				
	A-C	0	0			0				

## 00:45 - 01:00

Junction	Stream	Total Demand (PCU/hr)	Junction Arrivals (PCU)	Capacity (PCU/hr)	RFC	Throughput (PCU/hr)	Start queue (PCU)	End queue (PCU)	Delay (s)	Unsignalised level of service
1 - Junction Access	B-CD	46	11	270	0.169	46	0.2	0.2	16.077	C
	B-AD	46	11	281	0.163	46	0.2	0.2	15.285	C
	A-B	239	60			239				
	A-C	1250	312			1250				
	A-D	0	0	574	0.000	0	0.0	0.0	0.000	A
	D-ABC	0	0	408	0.000	0	0.0	0.0	0.000	A
	C-ABD	0	0	285	0.000	0	0.0	0.0	0.000	A
	C-D	0	0			0				
2 - Right Turn Bay Give Way	C-A	0	0			0				
	B-AC	0	0	630	0.000	0	0.0	0.0	0.000	A
	C-AB	0	0	570	0.000	0	0.0	0.0	0.000	A
	A-B	0	0			0				
	A-C	91	23			91				
3 - Eastbound Give Way	B-AC	91	23	555	0.165	91	0.2	0.2	7.770	A
	C-A	1005	251			1005				
	C-B	0	0	574	0.000	0	0.0	0.0	0.000	A
	A-B	0	0			0				
	A-C	0	0			0				

## 01:00 - 01:15

Junction	Stream	Total Demand (PCU/hr)	Junction Arrivals (PCU)	Capacity (PCU/hr)	RFC	Throughput (PCU/hr)	Start queue (PCU)	End queue (PCU)	Delay (s)	Unsignalised level of service
1 - Junction Access	B-CD	37	9	332	0.112	38	0.2	0.1	12.224	B
	B-AD	37	9	342	0.109	38	0.2	0.1	11.837	B
	A-B	195	49			195				
	A-C	1020	255			1020				
	A-D	0	0	574	0.000	0	0.0	0.0	0.000	A
	D-ABC	0	0	446	0.000	0	0.0	0.0	0.000	A
	C-ABD	0	0	338	0.000	0	0.0	0.0	0.000	A
	C-D	0	0			0				
2 - Right Turn Bay Give Way	C-A	0	0			0				
	B-AC	0	0	631	0.000	0	0.0	0.0	0.000	A
	C-AB	0	0	571	0.000	0	0.0	0.0	0.000	A
	A-B	0	0			0				
	A-C	75	19			75				
3 - Eastbound Give Way	B-AC	75	19	589	0.127	75	0.2	0.1	7.010	A
	C-A	821	205			821				
	C-B	0	0	574	0.000	0	0.0	0.0	0.000	A
	A-B	0	0			0				
	A-C	0	0			0				

## 01:15 - 01:30

Junction	Stream	Total Demand (PCU/hr)	Junction Arrivals (PCU)	Capacity (PCU/hr)	RFC	Throughput (PCU/hr)	Start queue (PCU)	End queue (PCU)	Delay (s)	Unsignalised level of service
1 - Junction Access	B-CD	31	8	378	0.083	31	0.1	0.1	10.394	B
	B-AD	31	8	386	0.081	31	0.1	0.1	10.158	B
	A-B	163	41			163				
	A-C	854	214			854				
	A-D	0	0	574	0.000	0	0.0	0.0	0.000	A
	D-ABC	0	0	472	0.000	0	0.0	0.0	0.000	A
	C-ABD	0	0	376	0.000	0	0.0	0.0	0.000	A
	C-D	0	0			0				
2 - Right Turn Bay Give Way	C-A	0	0			0				
	B-AC	0	0	632	0.000	0	0.0	0.0	0.000	A
	C-AB	0	0	571	0.000	0	0.0	0.0	0.000	A
	A-B	0	0			0				
	A-C	62	16			62				
3 - Eastbound Give Way	B-AC	62	16	613	0.102	63	0.1	0.1	6.538	A
	C-A	687	172			687				
	C-B	0	0	574	0.000	0	0.0	0.0	0.000	A
	A-B	0	0			0				
	A-C	0	0			0				

# Option 1 Demand, PM

## Data Errors and Warnings

Severity	Area	Item	Description
Warning	Vehicle Mix	1 - Junction Access	HV% is zero for all movements / time segments. Vehicle Mix matrix should be completed whether working in PCUs or Vehs. If HV% at the junction is genuinely zero, please ignore this warning.
Warning	Vehicle Mix	2 - Right Turn Bay Give Way	HV% is zero for all movements / time segments. Vehicle Mix matrix should be completed whether working in PCUs or Vehs. If HV% at the junction is genuinely zero, please ignore this warning.
Warning	Vehicle Mix	3 - Eastbound Give Way	HV% is zero for all movements / time segments. Vehicle Mix matrix should be completed whether working in PCUs or Vehs. If HV% at the junction is genuinely zero, please ignore this warning.

## Junction Network

### Junctions

Junction	Name	Junction type	Arm A Direction	Arm B Direction	Arm C Direction	Arm D Direction	Use circulating lanes	Junction Delay (s)	Junction LOS
1	Junction Access	Crossroads	Entry Only	Two-way	Exit Only	Two-way		0.82	A
2	Right Turn Bay Give Way	T-Junction	Two-way	Entry Only	Exit Only			0.00	A
3	Eastbound Give Way	T-Junction	Exit Only	Entry Only	Entry Only			0.56	A

### Junction Network

Driving side	Lighting	Network delay (s)	Network LOS
Left	Normal/unknown	0.67	A

## Traffic Demand

### Demand Set Details

ID	Scenario name	Time Period name	Traffic profile type	Start time (HH:mm)	Finish time (HH:mm)	Time segment length (min)	Run automatically
D2	Option 1 Demand	PM	ONE HOUR	00:00	01:30	15	✓

### Demand overview (Traffic)

Junction	Arm	Linked arm	Profile type	Use O-D data	Av. Demand (PCU/hr)	Scaling Factor (%)
1 - Junction Access	A - Pembury Road WB Entry		ONE HOUR	✓	1087	100.000
	B - Maidstone Road Junction Give Way		ONE HOUR	✓	78	100.000
	C - Pembury Road WB Exit		ONE HOUR	✓	0	100.000
	D - Pembury Road EB Right Turn Bay		ONE HOUR	✓	0	100.000
2 - Right Turn Bay Give Way	A - Maidstone Road Right Turn Storage Entry		ONE HOUR	✓	78	100.000
	B - Pembury Road EB Right Turn Bay		ONE HOUR	✓	0	100.000
	C - Maidstone Road Right Turn Storage Exit		ONE HOUR	✓	0	100.000
3 - Eastbound Give Way	A - Pembury Road EB Exit		ONE HOUR	✓	0	100.000
	B - Maidstone Road Second Give Way		ONE HOUR	✓	78	100.000
	C - Pembury Road EB Entry		ONE HOUR	✓	1087	100.000

## Origin-Destination Data

**Demand (PCU/hr)**

**1 - Junction Access**

		To			
		A - Pembury Road WB Entry	B - Maidstone Road Junction Give Way	C - Pembury Road WB Exit	D - Pembury Road EB Right Turn Bay
From	A - Pembury Road WB Entry	0	151	936	0
	B - Maidstone Road Junction Give Way	0	0	0	78
	C - Pembury Road WB Exit	0	0	0	0
	D - Pembury Road EB Right Turn Bay	0	0	0	0

**Demand (PCU/hr)**

**2 - Right Turn Bay Give Way**

		To		
		A - Maidstone Road Right Turn Storage Entry	B - Pembury Road EB Right Turn Bay	C - Maidstone Road Right Turn Storage Exit
From	A - Maidstone Road Right Turn Storage Entry	0	0	78
	B - Pembury Road EB Right Turn Bay	0	0	0
	C - Maidstone Road Right Turn Storage Exit	0	0	0

**Demand (PCU/hr)**

**3 - Eastbound Give Way**

		To		
		A - Pembury Road EB Exit	B - Maidstone Road Second Give Way	C - Pembury Road EB Entry
From	A - Pembury Road EB Exit	0	0	0
	B - Maidstone Road Second Give Way	78	0	0
	C - Pembury Road EB Entry	1087	0	0

## Vehicle Mix

HV data entry mode	PCU Factor for a HV (PCU)
HV Percentages	2.00

**Heavy Vehicle %**

**1 - Junction Access**

		To			
		A - Pembury Road WB Entry	B - Maidstone Road Junction Give Way	C - Pembury Road WB Exit	D - Pembury Road EB Right Turn Bay
From	A - Pembury Road WB Entry	0	0	0	0
	B - Maidstone Road Junction Give Way	0	0	0	0
	C - Pembury Road WB Exit	0	0	0	0
	D - Pembury Road EB Right Turn Bay	0	0	0	0

**Heavy Vehicle %**

**2 - Right Turn Bay Give Way**

		To		
		A - Maidstone Road Right Turn Storage Entry	B - Pembury Road EB Right Turn Bay	C - Maidstone Road Right Turn Storage Exit
From	A - Maidstone Road Right Turn Storage Entry	0	0	0
	B - Pembury Road EB Right Turn Bay	0	0	0
	C - Maidstone Road Right Turn Storage Exit	0	0	0



Heavy Vehicle %

3 - Eastbound Give Way

		To		
From		A - Pembury Road EB Exit	B - Maidstone Road Second Give Way	C - Pembury Road EB Entry
	A - Pembury Road EB Exit	0	0	0
	B - Maidstone Road Second Give Way	0	0	0
	C - Pembury Road EB Entry	0	0	0

## Results

Results Summary for whole modelled period

Junction	Stream	Max RFC	Max Delay (s)	Max Q (PCU)	Max LOS	Av. Demand (PCU/hr)	Total Junction Arrivals (PCU)
1 - Junction Access	B-CD	0.13	12.48	0.1	B	36	54
	B-AD	0.13	12.03	0.1	B	36	54
	A-B					139	208
	A-C					859	1288
	A-D	0.00	0.00	0.0	A	0	0
	D-ABC	0.00	0.00	0.0	A	0	0
	C-ABD	0.00	0.00	0.0	A	0	0
	C-D					0	0
2 - Right Turn Bay Give Way	C-A					0	0
	B-AC	0.00	0.00	0.0	A	0	0
	C-AB	0.00	0.00	0.0	A	0	0
	A-B					0	0
	A-C					72	107
3 - Eastbound Give Way	B-AC	0.17	8.30	0.2	A	72	107
	C-A					997	1496
	C-B	0.00	0.00	0.0	A	0	0
	A-B					0	0
	A-C					0	0

### Main Results for each time segment

#### 00:00 - 00:15

Junction	Stream	Total Demand (PCU/hr)	Junction Arrivals (PCU)	Capacity (PCU/hr)	RFC	Throughput (PCU/hr)	Start queue (PCU)	End queue (PCU)	Delay (s)	Unsignalised level of service
1 - Junction Access	B-CD	29	7	420	0.070	29	0.0	0.1	9.196	A
	B-AD	29	7	428	0.069	29	0.0	0.1	9.026	A
	A-B	114	28			114				
	A-C	705	176			705				
	A-D	0	0	574	0.000	0	0.0	0.0	0.000	A
	D-ABC	0	0	496	0.000	0	0.0	0.0	0.000	A
	C-ABD	0	0	415	0.000	0	0.0	0.0	0.000	A
	C-D	0	0			0				
2 - Right Turn Bay Give Way	C-A	0	0			0				
	B-AC	0	0	632	0.000	0	0.0	0.0	0.000	A
	C-AB	0	0	572	0.000	0	0.0	0.0	0.000	A
	A-B	0	0			0				
	A-C	59	15			59				
3 - Eastbound Give Way	B-AC	59	15	589	0.100	58	0.0	0.1	6.776	A
	C-A	818	205			818				
	C-B	0	0	574	0.000	0	0.0	0.0	0.000	A
	A-B	0	0			0				
	A-C	0	0			0				

#### 00:15 - 00:30

Junction	Stream	Total Demand (PCU/hr)	Junction Arrivals (PCU)	Capacity (PCU/hr)	RFC	Throughput (PCU/hr)	Start queue (PCU)	End queue (PCU)	Delay (s)	Unsignalised level of service
1 - Junction Access	B-CD	35	9	383	0.092	35	0.1	0.1	10.341	B
	B-AD	35	9	392	0.089	35	0.1	0.1	10.087	B
	A-B	136	34			136				
	A-C	841	210			841				
	A-D	0	0	574	0.000	0	0.0	0.0	0.000	A
	D-ABC	0	0	475	0.000	0	0.0	0.0	0.000	A
	C-ABD	0	0	384	0.000	0	0.0	0.0	0.000	A
	C-D	0	0			0				
2 - Right Turn Bay Give Way	C-A	0	0			0				
	B-AC	0	0	631	0.000	0	0.0	0.0	0.000	A
	C-AB	0	0	571	0.000	0	0.0	0.0	0.000	A
	A-B	0	0			0				
	A-C	70	18			70				
3 - Eastbound Give Way	B-AC	70	18	560	0.125	70	0.1	0.1	7.347	A
	C-A	977	244			977				
	C-B	0	0	574	0.000	0	0.0	0.0	0.000	A
	A-B	0	0			0				
	A-C	0	0			0				

## 00:30 - 00:45

Junction	Stream	Total Demand (PCU/hr)	Junction Arrivals (PCU)	Capacity (PCU/hr)	RFC	Throughput (PCU/hr)	Start queue (PCU)	End queue (PCU)	Delay (s)	Unsignalised level of service
1 - Junction Access	B-CD	43	11	331	0.130	43	0.1	0.1	12.464	B
	B-AD	43	11	342	0.125	43	0.1	0.1	12.013	B
	A-B	166	42			166				
	A-C	1031	258			1031				
	A-D	0	0	574	0.000	0	0.0	0.0	0.000	A
	D-ABC	0	0	446	0.000	0	0.0	0.0	0.000	A
	C-ABD	0	0	341	0.000	0	0.0	0.0	0.000	A
	C-D	0	0			0				
2 - Right Turn Bay Give Way	C-A	0	0			0				
	B-AC	0	0	630	0.000	0	0.0	0.0	0.000	A
	C-AB	0	0	570	0.000	0	0.0	0.0	0.000	A
	A-B	0	0			0				
	A-C	86	21			86				
3 - Eastbound Give Way	B-AC	86	21	519	0.165	86	0.1	0.2	8.297	A
	C-A	1197	299			1197				
	C-B	0	0	574	0.000	0	0.0	0.0	0.000	A
	A-B	0	0			0				
	A-C	0	0			0				

## 00:45 - 01:00

Junction	Stream	Total Demand (PCU/hr)	Junction Arrivals (PCU)	Capacity (PCU/hr)	RFC	Throughput (PCU/hr)	Start queue (PCU)	End queue (PCU)	Delay (s)	Unsignalised level of service
1 - Junction Access	B-CD	43	11	331	0.130	43	0.1	0.1	12.480	B
	B-AD	43	11	342	0.125	43	0.1	0.1	12.027	B
	A-B	166	42			166				
	A-C	1031	258			1031				
	A-D	0	0	574	0.000	0	0.0	0.0	0.000	A
	D-ABC	0	0	446	0.000	0	0.0	0.0	0.000	A
	C-ABD	0	0	341	0.000	0	0.0	0.0	0.000	A
	C-D	0	0			0				
2 - Right Turn Bay Give Way	C-A	0	0			0				
	B-AC	0	0	630	0.000	0	0.0	0.0	0.000	A
	C-AB	0	0	570	0.000	0	0.0	0.0	0.000	A
	A-B	0	0			0				
	A-C	86	21			86				
3 - Eastbound Give Way	B-AC	86	21	519	0.165	86	0.2	0.2	8.305	A
	C-A	1197	299			1197				
	C-B	0	0	574	0.000	0	0.0	0.0	0.000	A
	A-B	0	0			0				
	A-C	0	0			0				

## 01:00 - 01:15

Junction	Stream	Total Demand (PCU/hr)	Junction Arrivals (PCU)	Capacity (PCU/hr)	RFC	Throughput (PCU/hr)	Start queue (PCU)	End queue (PCU)	Delay (s)	Unsignalised level of service
1 - Junction Access	B-CD	35	9	383	0.092	35	0.1	0.1	10.362	B
	B-AD	35	9	392	0.089	35	0.1	0.1	10.103	B
	A-B	136	34			136				
	A-C	841	210			841				
	A-D	0	0	574	0.000	0	0.0	0.0	0.000	A
	D-ABC	0	0	475	0.000	0	0.0	0.0	0.000	A
	C-ABD	0	0	384	0.000	0	0.0	0.0	0.000	A
	C-D	0	0			0				
2 - Right Turn Bay Give Way	C-A	0	0			0				
	B-AC	0	0	631	0.000	0	0.0	0.0	0.000	A
	C-AB	0	0	571	0.000	0	0.0	0.0	0.000	A
	A-B	0	0			0				
	A-C	70	18			70				
3 - Eastbound Give Way	B-AC	70	18	560	0.125	70	0.2	0.1	7.359	A
	C-A	977	244			977				
	C-B	0	0	574	0.000	0	0.0	0.0	0.000	A
	A-B	0	0			0				
	A-C	0	0			0				

## 01:15 - 01:30

Junction	Stream	Total Demand (PCU/hr)	Junction Arrivals (PCU)	Capacity (PCU/hr)	RFC	Throughput (PCU/hr)	Start queue (PCU)	End queue (PCU)	Delay (s)	Unsignalised level of service
1 - Junction Access	B-CD	29	7	420	0.070	29	0.1	0.1	9.218	A
	B-AD	29	7	428	0.069	29	0.1	0.1	9.045	A
	A-B	114	28			114				
	A-C	705	176			705				
	A-D	0	0	574	0.000	0	0.0	0.0	0.000	A
	D-ABC	0	0	496	0.000	0	0.0	0.0	0.000	A
	C-ABD	0	0	415	0.000	0	0.0	0.0	0.000	A
	C-D	0	0			0				
2 - Right Turn Bay Give Way	C-A	0	0			0				
	B-AC	0	0	632	0.000	0	0.0	0.0	0.000	A
	C-AB	0	0	572	0.000	0	0.0	0.0	0.000	A
	A-B	0	0			0				
	A-C	59	15			59				
3 - Eastbound Give Way	B-AC	59	15	589	0.100	59	0.1	0.1	6.790	A
	C-A	818	205			818				
	C-B	0	0	574	0.000	0	0.0	0.0	0.000	A
	A-B	0	0			0				
	A-C	0	0			0				

# Option 2 Demand, AM

## Data Errors and Warnings

Severity	Area	Item	Description
Warning	Vehicle Mix	1 - Junction Access	HV% is zero for all movements / time segments. Vehicle Mix matrix should be completed whether working in PCUs or Vehs. If HV% at the junction is genuinely zero, please ignore this warning.
Warning	Vehicle Mix	2 - Right Turn Bay Give Way	HV% is zero for all movements / time segments. Vehicle Mix matrix should be completed whether working in PCUs or Vehs. If HV% at the junction is genuinely zero, please ignore this warning.
Warning	Vehicle Mix	3 - Eastbound Give Way	HV% is zero for all movements / time segments. Vehicle Mix matrix should be completed whether working in PCUs or Vehs. If HV% at the junction is genuinely zero, please ignore this warning.

## Junction Network

### Junctions

Junction	Name	Junction type	Arm A Direction	Arm B Direction	Arm C Direction	Arm D Direction	Use circulating lanes	Junction Delay (s)	Junction LOS
1	Junction Access	Crossroads	Entry Only	Two-way	Exit Only	Two-way		0.77	A
2	Right Turn Bay Give Way	T-Junction	Two-way	Entry Only	Exit Only			0.00	A
3	Eastbound Give Way	T-Junction	Exit Only	Entry Only	Entry Only			0.53	A

### Junction Network

Driving side	Lighting	Network delay (s)	Network LOS
Left	Normal/unknown	0.65	A

## Traffic Demand

### Demand Set Details

ID	Scenario name	Time Period name	Traffic profile type	Start time (HH:mm)	Finish time (HH:mm)	Time segment length (min)	Run automatically
D3	Option 2 Demand	AM	ONE HOUR	00:00	01:30	15	✓

### Demand overview (Traffic)

Junction	Arm	Linked arm	Profile type	Use O-D data	Av. Demand (PCU/hr)	Scaling Factor (%)
1 - Junction Access	A - Pembury Road WB Entry		ONE HOUR	✓	1385	100.000
	B - Maidstone Road Junction Give Way		ONE HOUR	✓	70	100.000
	C - Pembury Road WB Exit		ONE HOUR	✓	0	100.000
	D - Pembury Road EB Right Turn Bay		ONE HOUR	✓	0	100.000
2 - Right Turn Bay Give Way	A - Maidstone Road Right Turn Storage Entry		ONE HOUR	✓	70	100.000
	B - Pembury Road EB Right Turn Bay		ONE HOUR	✓	0	100.000
	C - Maidstone Road Right Turn Storage Exit		ONE HOUR	✓	0	100.000
3 - Eastbound Give Way	A - Pembury Road EB Exit		ONE HOUR	✓	0	100.000
	B - Maidstone Road Second Give Way		ONE HOUR	✓	70	100.000
	C - Pembury Road EB Entry		ONE HOUR	✓	939	100.000

## Origin-Destination Data

**Demand (PCU/hr)**

**1 - Junction Access**

		To			
		A - Pembury Road WB Entry	B - Maidstone Road Junction Give Way	C - Pembury Road WB Exit	D - Pembury Road EB Right Turn Bay
From	A - Pembury Road WB Entry	0	188	1197	0
	B - Maidstone Road Junction Give Way	0	0	0	70
	C - Pembury Road WB Exit	0	0	0	0
	D - Pembury Road EB Right Turn Bay	0	0	0	0

**Demand (PCU/hr)**

**2 - Right Turn Bay Give Way**

		To		
		A - Maidstone Road Right Turn Storage Entry	B - Pembury Road EB Right Turn Bay	C - Maidstone Road Right Turn Storage Exit
From	A - Maidstone Road Right Turn Storage Entry	0	0	70
	B - Pembury Road EB Right Turn Bay	0	0	0
	C - Maidstone Road Right Turn Storage Exit	0	0	0

**Demand (PCU/hr)**

**3 - Eastbound Give Way**

		To		
		A - Pembury Road EB Exit	B - Maidstone Road Second Give Way	C - Pembury Road EB Entry
From	A - Pembury Road EB Exit	0	0	0
	B - Maidstone Road Second Give Way	70	0	0
	C - Pembury Road EB Entry	939	0	0

## Vehicle Mix

HV data entry mode	PCU Factor for a HV (PCU)
HV Percentages	2.00

**Heavy Vehicle %**

**1 - Junction Access**

		To			
		A - Pembury Road WB Entry	B - Maidstone Road Junction Give Way	C - Pembury Road WB Exit	D - Pembury Road EB Right Turn Bay
From	A - Pembury Road WB Entry	0	0	0	0
	B - Maidstone Road Junction Give Way	0	0	0	0
	C - Pembury Road WB Exit	0	0	0	0
	D - Pembury Road EB Right Turn Bay	0	0	0	0

**Heavy Vehicle %**

**2 - Right Turn Bay Give Way**

		To		
		A - Maidstone Road Right Turn Storage Entry	B - Pembury Road EB Right Turn Bay	C - Maidstone Road Right Turn Storage Exit
From	A - Maidstone Road Right Turn Storage Entry	0	0	0
	B - Pembury Road EB Right Turn Bay	0	0	0
	C - Maidstone Road Right Turn Storage Exit	0	0	0

Heavy Vehicle %

3 - Eastbound Give Way

		To		
From		A - Pembury Road EB Exit	B - Maidstone Road Second Give Way	C - Pembury Road EB Entry
	A - Pembury Road EB Exit	0	0	0
	B - Maidstone Road Second Give Way	0	0	0
	C - Pembury Road EB Entry	0	0	0

## Results

Results Summary for whole modelled period

Junction	Stream	Max RFC	Max Delay (s)	Max Q (PCU)	Max LOS	Av. Demand (PCU/hr)	Total Junction Arrivals (PCU)
1 - Junction Access	B-CD	0.15	16.42	0.2	C	32	48
	B-AD	0.14	15.72	0.2	C	32	48
	A-B					173	259
	A-C					1098	1648
	A-D	0.00	0.00	0.0	A	0	0
	D-ABC	0.00	0.00	0.0	A	0	0
	C-ABD	0.00	0.00	0.0	A	0	0
	C-D					0	0
2 - Right Turn Bay Give Way	C-A					0	0
	B-AC	0.00	0.00	0.0	A	0	0
	C-AB	0.00	0.00	0.0	A	0	0
	A-B					0	0
	A-C					64	96
3 - Eastbound Give Way	B-AC	0.14	7.62	0.2	A	64	96
	C-A					862	1292
	C-B	0.00	0.00	0.0	A	0	0
	A-B					0	0
	A-C					0	0

### Main Results for each time segment

#### 00:00 - 00:15

Junction	Stream	Total Demand (PCU/hr)	Junction Arrivals (PCU)	Capacity (PCU/hr)	RFC	Throughput (PCU/hr)	Start queue (PCU)	End queue (PCU)	Delay (s)	Unsignalised level of service
1 - Junction Access	B-CD	26	7	370	0.071	26	0.0	0.1	10.461	B
	B-AD	26	7	377	0.070	26	0.0	0.1	10.264	B
	A-B	142	35			142				
	A-C	901	225			901				
	A-D	0	0	574	0.000	0	0.0	0.0	0.000	A
	D-ABC	0	0	468	0.000	0	0.0	0.0	0.000	A
	C-ABD	0	0	371	0.000	0	0.0	0.0	0.000	A
	C-D	0	0			0				
2 - Right Turn Bay Give Way	C-A	0	0			0				
	B-AC	0	0	633	0.000	0	0.0	0.0	0.000	A
	C-AB	0	0	572	0.000	0	0.0	0.0	0.000	A
	A-B	0	0			0				
	A-C	53	13			53				
3 - Eastbound Give Way	B-AC	53	13	610	0.086	52	0.0	0.1	6.455	A
	C-A	707	177			707				
	C-B	0	0	574	0.000	0	0.0	0.0	0.000	A
	A-B	0	0			0				
	A-C	0	0			0				

#### 00:15 - 00:30

Junction	Stream	Total Demand (PCU/hr)	Junction Arrivals (PCU)	Capacity (PCU/hr)	RFC	Throughput (PCU/hr)	Start queue (PCU)	End queue (PCU)	Delay (s)	Unsignalised level of service
1 - Junction Access	B-CD	31	8	323	0.097	31	0.1	0.1	12.345	B
	B-AD	31	8	331	0.095	31	0.1	0.1	12.014	B
	A-B	169	42			169				
	A-C	1076	269			1076				
	A-D	0	0	574	0.000	0	0.0	0.0	0.000	A
	D-ABC	0	0	441	0.000	0	0.0	0.0	0.000	A
	C-ABD	0	0	332	0.000	0	0.0	0.0	0.000	A
	C-D	0	0			0				
2 - Right Turn Bay Give Way	C-A	0	0			0				
	B-AC	0	0	632	0.000	0	0.0	0.0	0.000	A
	C-AB	0	0	571	0.000	0	0.0	0.0	0.000	A
	A-B	0	0			0				
	A-C	63	16			63				
3 - Eastbound Give Way	B-AC	63	16	584	0.108	63	0.1	0.1	6.900	A
	C-A	844	211			844				
	C-B	0	0	574	0.000	0	0.0	0.0	0.000	A
	A-B	0	0			0				
	A-C	0	0			0				



## 00:30 - 00:45

Junction	Stream	Total Demand (PCU/hr)	Junction Arrivals (PCU)	Capacity (PCU/hr)	RFC	Throughput (PCU/hr)	Start queue (PCU)	End queue (PCU)	Delay (s)	Unsignalised level of service
1 - Junction Access	B-CD	39	10	258	0.150	38	0.1	0.2	16.381	C
	B-AD	39	10	268	0.144	38	0.1	0.2	15.687	C
	A-B	207	52			207				
	A-C	1318	329			1318				
	A-D	0	0	574	0.000	0	0.0	0.0	0.000	A
	D-ABC	0	0	403	0.000	0	0.0	0.0	0.000	A
	C-ABD	0	0	278	0.000	0	0.0	0.0	0.000	A
	C-D	0	0			0				
2 - Right Turn Bay Give Way	C-A	0	0			0				
	B-AC	0	0	631	0.000	0	0.0	0.0	0.000	A
	C-AB	0	0	571	0.000	0	0.0	0.0	0.000	A
	A-B	0	0			0				
	A-C	77	19			77				
3 - Eastbound Give Way	B-AC	77	19	549	0.140	77	0.1	0.2	7.618	A
	C-A	1034	258			1034				
	C-B	0	0	574	0.000	0	0.0	0.0	0.000	A
	A-B	0	0			0				
	A-C	0	0			0				

## 00:45 - 01:00

Junction	Stream	Total Demand (PCU/hr)	Junction Arrivals (PCU)	Capacity (PCU/hr)	RFC	Throughput (PCU/hr)	Start queue (PCU)	End queue (PCU)	Delay (s)	Unsignalised level of service
1 - Junction Access	B-CD	39	10	258	0.150	39	0.2	0.2	16.423	C
	B-AD	39	10	268	0.144	39	0.2	0.2	15.720	C
	A-B	207	52			207				
	A-C	1318	329			1318				
	A-D	0	0	574	0.000	0	0.0	0.0	0.000	A
	D-ABC	0	0	403	0.000	0	0.0	0.0	0.000	A
	C-ABD	0	0	278	0.000	0	0.0	0.0	0.000	A
	C-D	0	0			0				
2 - Right Turn Bay Give Way	C-A	0	0			0				
	B-AC	0	0	631	0.000	0	0.0	0.0	0.000	A
	C-AB	0	0	571	0.000	0	0.0	0.0	0.000	A
	A-B	0	0			0				
	A-C	77	19			77				
3 - Eastbound Give Way	B-AC	77	19	549	0.140	77	0.2	0.2	7.621	A
	C-A	1034	258			1034				
	C-B	0	0	574	0.000	0	0.0	0.0	0.000	A
	A-B	0	0			0				
	A-C	0	0			0				

## 01:00 - 01:15

Junction	Stream	Total Demand (PCU/hr)	Junction Arrivals (PCU)	Capacity (PCU/hr)	RFC	Throughput (PCU/hr)	Start queue (PCU)	End queue (PCU)	Delay (s)	Unsignalised level of service
1 - Junction Access	B-CD	31	8	323	0.097	32	0.2	0.1	12.383	B
	B-AD	31	8	331	0.095	32	0.2	0.1	12.048	B
	A-B	169	42			169				
	A-C	1076	269			1076				
	A-D	0	0	574	0.000	0	0.0	0.0	0.000	A
	D-ABC	0	0	441	0.000	0	0.0	0.0	0.000	A
	C-ABD	0	0	332	0.000	0	0.0	0.0	0.000	A
	C-D	0	0			0				
2 - Right Turn Bay Give Way	C-A	0	0			0				
	B-AC	0	0	632	0.000	0	0.0	0.0	0.000	A
	C-AB	0	0	571	0.000	0	0.0	0.0	0.000	A
	A-B	0	0			0				
	A-C	63	16			63				
3 - Eastbound Give Way	B-AC	63	16	584	0.108	63	0.2	0.1	6.907	A
	C-A	844	211			844				
	C-B	0	0	574	0.000	0	0.0	0.0	0.000	A
	A-B	0	0			0				
	A-C	0	0			0				

## 01:15 - 01:30

Junction	Stream	Total Demand (PCU/hr)	Junction Arrivals (PCU)	Capacity (PCU/hr)	RFC	Throughput (PCU/hr)	Start queue (PCU)	End queue (PCU)	Delay (s)	Unsignalised level of service
1 - Junction Access	B-CD	26	7	370	0.071	26	0.1	0.1	10.488	B
	B-AD	26	7	377	0.070	26	0.1	0.1	10.287	B
	A-B	142	35			142				
	A-C	901	225			901				
	A-D	0	0	574	0.000	0	0.0	0.0	0.000	A
	D-ABC	0	0	468	0.000	0	0.0	0.0	0.000	A
	C-ABD	0	0	371	0.000	0	0.0	0.0	0.000	A
	C-D	0	0			0				
2 - Right Turn Bay Give Way	C-A	0	0			0				
	B-AC	0	0	633	0.000	0	0.0	0.0	0.000	A
	C-AB	0	0	572	0.000	0	0.0	0.0	0.000	A
	A-B	0	0			0				
	A-C	53	13			53				
3 - Eastbound Give Way	B-AC	53	13	610	0.086	53	0.1	0.1	6.465	A
	C-A	707	177			707				
	C-B	0	0	574	0.000	0	0.0	0.0	0.000	A
	A-B	0	0			0				
	A-C	0	0			0				

# Option 2 Demand, PM

## Data Errors and Warnings

Severity	Area	Item	Description
Warning	Vehicle Mix	1 - Junction Access	HV% is zero for all movements / time segments. Vehicle Mix matrix should be completed whether working in PCUs or Vehs. If HV% at the junction is genuinely zero, please ignore this warning.
Warning	Vehicle Mix	2 - Right Turn Bay Give Way	HV% is zero for all movements / time segments. Vehicle Mix matrix should be completed whether working in PCUs or Vehs. If HV% at the junction is genuinely zero, please ignore this warning.
Warning	Vehicle Mix	3 - Eastbound Give Way	HV% is zero for all movements / time segments. Vehicle Mix matrix should be completed whether working in PCUs or Vehs. If HV% at the junction is genuinely zero, please ignore this warning.

## Junction Network

### Junctions

Junction	Name	Junction type	Arm A Direction	Arm B Direction	Arm C Direction	Arm D Direction	Use circulating lanes	Junction Delay (s)	Junction LOS
1	Junction Access	Crossroads	Entry Only	Two-way	Exit Only	Two-way		0.50	A
2	Right Turn Bay Give Way	T-Junction	Two-way	Entry Only	Exit Only			0.00	A
3	Eastbound Give Way	T-Junction	Exit Only	Entry Only	Entry Only			0.32	A

### Junction Network

Driving side	Lighting	Network delay (s)	Network LOS
Left	Normal/unknown	0.40	A

## Traffic Demand

### Demand Set Details

ID	Scenario name	Time Period name	Traffic profile type	Start time (HH:mm)	Finish time (HH:mm)	Time segment length (min)	Run automatically
D4	Option 2 Demand	PM	ONE HOUR	00:00	01:30	15	✓

### Demand overview (Traffic)

Junction	Arm	Linked arm	Profile type	Use O-D data	Av. Demand (PCU/hr)	Scaling Factor (%)
1 - Junction Access	A - Pembury Road WB Entry		ONE HOUR	✓	1089	100.000
	B - Maidstone Road Junction Give Way		ONE HOUR	✓	49	100.000
	C - Pembury Road WB Exit		ONE HOUR	✓	0	100.000
	D - Pembury Road EB Right Turn Bay		ONE HOUR	✓	0	100.000
2 - Right Turn Bay Give Way	A - Maidstone Road Right Turn Storage Entry		ONE HOUR	✓	49	100.000
	B - Pembury Road EB Right Turn Bay		ONE HOUR	✓	0	100.000
	C - Maidstone Road Right Turn Storage Exit		ONE HOUR	✓	0	100.000
3 - Eastbound Give Way	A - Pembury Road EB Exit		ONE HOUR	✓	0	100.000
	B - Maidstone Road Second Give Way		ONE HOUR	✓	49	100.000
	C - Pembury Road EB Entry		ONE HOUR	✓	1207	100.000

## Origin-Destination Data

**Demand (PCU/hr)**

**1 - Junction Access**

		To			
		A - Pembury Road WB Entry	B - Maidstone Road Junction Give Way	C - Pembury Road WB Exit	D - Pembury Road EB Right Turn Bay
From	A - Pembury Road WB Entry	0	151	938	0
	B - Maidstone Road Junction Give Way	0	0	0	49
	C - Pembury Road WB Exit	0	0	0	0
	D - Pembury Road EB Right Turn Bay	0	0	0	0

**Demand (PCU/hr)**

**2 - Right Turn Bay Give Way**

		To		
		A - Maidstone Road Right Turn Storage Entry	B - Pembury Road EB Right Turn Bay	C - Maidstone Road Right Turn Storage Exit
From	A - Maidstone Road Right Turn Storage Entry	0	0	49
	B - Pembury Road EB Right Turn Bay	0	0	0
	C - Maidstone Road Right Turn Storage Exit	0	0	0

**Demand (PCU/hr)**

**3 - Eastbound Give Way**

		To		
		A - Pembury Road EB Exit	B - Maidstone Road Second Give Way	C - Pembury Road EB Entry
From	A - Pembury Road EB Exit	0	0	0
	B - Maidstone Road Second Give Way	49	0	0
	C - Pembury Road EB Entry	1207	0	0

## Vehicle Mix

HV data entry mode	PCU Factor for a HV (PCU)
HV Percentages	2.00

**Heavy Vehicle %**

**1 - Junction Access**

		To			
		A - Pembury Road WB Entry	B - Maidstone Road Junction Give Way	C - Pembury Road WB Exit	D - Pembury Road EB Right Turn Bay
From	A - Pembury Road WB Entry	0	0	0	0
	B - Maidstone Road Junction Give Way	0	0	0	0
	C - Pembury Road WB Exit	0	0	0	0
	D - Pembury Road EB Right Turn Bay	0	0	0	0

**Heavy Vehicle %**

**2 - Right Turn Bay Give Way**

		To		
		A - Maidstone Road Right Turn Storage Entry	B - Pembury Road EB Right Turn Bay	C - Maidstone Road Right Turn Storage Exit
From	A - Maidstone Road Right Turn Storage Entry	0	0	0
	B - Pembury Road EB Right Turn Bay	0	0	0
	C - Maidstone Road Right Turn Storage Exit	0	0	0

Heavy Vehicle %

3 - Eastbound Give Way

		To		
		A - Pembury Road EB Exit	B - Maidstone Road Second Give Way	C - Pembury Road EB Entry
From	A - Pembury Road EB Exit	0	0	0
	B - Maidstone Road Second Give Way	0	0	0
	C - Pembury Road EB Entry	0	0	0

## Results

Results Summary for whole modelled period

Junction	Stream	Max RFC	Max Delay (s)	Max Q (PCU)	Max LOS	Av. Demand (PCU/hr)	Total Junction Arrivals (PCU)
1 - Junction Access	B-CD	0.08	11.69	0.1	B	22	34
	B-AD	0.08	11.44	0.1	B	22	34
	A-B					139	208
	A-C					861	1291
	A-D	0.00	0.00	0.0	A	0	0
	D-ABC	0.00	0.00	0.0	A	0	0
	C-ABD	0.00	0.00	0.0	A	0	0
	C-D					0	0
2 - Right Turn Bay Give Way	C-A					0	0
	B-AC	0.00	0.00	0.0	A	0	0
	C-AB	0.00	0.00	0.0	A	0	0
	A-B					0	0
	A-C					45	67
3 - Eastbound Give Way	B-AC	0.11	8.16	0.1	A	45	67
	C-A					1108	1661
	C-B	0.00	0.00	0.0	A	0	0
	A-B					0	0
	A-C					0	0

## Main Results for each time segment

### 00:00 - 00:15

Junction	Stream	Total Demand (PCU/hr)	Junction Arrivals (PCU)	Capacity (PCU/hr)	RFC	Throughput (PCU/hr)	Start queue (PCU)	End queue (PCU)	Delay (s)	Unsignalised level of service
1 - Junction Access	B-CD	18	5	423	0.044	18	0.0	0.0	8.899	A
	B-AD	18	5	427	0.043	18	0.0	0.0	8.799	A
	A-B	114	28			114				
	A-C	706	177			706				
	A-D	0	0	574	0.000	0	0.0	0.0	0.000	A
	D-ABC	0	0	498	0.000	0	0.0	0.0	0.000	A
	C-ABD	0	0	415	0.000	0	0.0	0.0	0.000	A
	C-D	0	0			0				
2 - Right Turn Bay Give Way	C-A	0	0			0				
	B-AC	0	0	634	0.000	0	0.0	0.0	0.000	A
	C-AB	0	0	572	0.000	0	0.0	0.0	0.000	A
	A-B	0	0			0				
	A-C	37	9			37				
3 - Eastbound Give Way	B-AC	37	9	572	0.064	37	0.0	0.1	6.716	A
	C-A	909	227			909				
	C-B	0	0	574	0.000	0	0.0	0.0	0.000	A
	A-B	0	0			0				
	A-C	0	0			0				

### 00:15 - 00:30

Junction	Stream	Total Demand (PCU/hr)	Junction Arrivals (PCU)	Capacity (PCU/hr)	RFC	Throughput (PCU/hr)	Start queue (PCU)	End queue (PCU)	Delay (s)	Unsignalised level of service
1 - Junction Access	B-CD	22	6	386	0.057	22	0.0	0.1	9.894	A
	B-AD	22	6	391	0.056	22	0.0	0.1	9.745	A
	A-B	136	34			136				
	A-C	843	211			843				
	A-D	0	0	574	0.000	0	0.0	0.0	0.000	A
	D-ABC	0	0	477	0.000	0	0.0	0.0	0.000	A
	C-ABD	0	0	384	0.000	0	0.0	0.0	0.000	A
	C-D	0	0			0				
2 - Right Turn Bay Give Way	C-A	0	0			0				
	B-AC	0	0	633	0.000	0	0.0	0.0	0.000	A
	C-AB	0	0	572	0.000	0	0.0	0.0	0.000	A
	A-B	0	0			0				
	A-C	44	11			44				
3 - Eastbound Give Way	B-AC	44	11	540	0.082	44	0.1	0.1	7.259	A
	C-A	1085	271			1085				
	C-B	0	0	574	0.000	0	0.0	0.0	0.000	A
	A-B	0	0			0				
	A-C	0	0			0				

## 00:30 - 00:45

Junction	Stream	Total Demand (PCU/hr)	Junction Arrivals (PCU)	Capacity (PCU/hr)	RFC	Throughput (PCU/hr)	Start queue (PCU)	End queue (PCU)	Delay (s)	Unsignalised level of service
1 - Junction Access	B-CD	27	7	335	0.081	27	0.1	0.1	11.683	B
	B-AD	27	7	342	0.079	27	0.1	0.1	11.431	B
	A-B	166	42			166				
	A-C	1033	258			1033				
	A-D	0	0	574	0.000	0	0.0	0.0	0.000	A
	D-ABC	0	0	448	0.000	0	0.0	0.0	0.000	A
	C-ABD	0	0	341	0.000	0	0.0	0.0	0.000	A
	C-D	0	0			0				
2 - Right Turn Bay Give Way	C-A	0	0			0				
	B-AC	0	0	632	0.000	0	0.0	0.0	0.000	A
	C-AB	0	0	572	0.000	0	0.0	0.0	0.000	A
	A-B	0	0			0				
	A-C	54	13			54				
3 - Eastbound Give Way	B-AC	54	13	495	0.109	54	0.1	0.1	8.158	A
	C-A	1329	332			1329				
	C-B	0	0	574	0.000	0	0.0	0.0	0.000	A
	A-B	0	0			0				
	A-C	0	0			0				

## 00:45 - 01:00

Junction	Stream	Total Demand (PCU/hr)	Junction Arrivals (PCU)	Capacity (PCU/hr)	RFC	Throughput (PCU/hr)	Start queue (PCU)	End queue (PCU)	Delay (s)	Unsignalised level of service
1 - Junction Access	B-CD	27	7	335	0.081	27	0.1	0.1	11.691	B
	B-AD	27	7	342	0.079	27	0.1	0.1	11.437	B
	A-B	166	42			166				
	A-C	1033	258			1033				
	A-D	0	0	574	0.000	0	0.0	0.0	0.000	A
	D-ABC	0	0	448	0.000	0	0.0	0.0	0.000	A
	C-ABD	0	0	341	0.000	0	0.0	0.0	0.000	A
	C-D	0	0			0				
2 - Right Turn Bay Give Way	C-A	0	0			0				
	B-AC	0	0	632	0.000	0	0.0	0.0	0.000	A
	C-AB	0	0	572	0.000	0	0.0	0.0	0.000	A
	A-B	0	0			0				
	A-C	54	13			54				
3 - Eastbound Give Way	B-AC	54	13	495	0.109	54	0.1	0.1	8.162	A
	C-A	1329	332			1329				
	C-B	0	0	574	0.000	0	0.0	0.0	0.000	A
	A-B	0	0			0				
	A-C	0	0			0				

01:00 - 01:15

Junction	Stream	Total Demand (PCU/hr)	Junction Arrivals (PCU)	Capacity (PCU/hr)	RFC	Throughput (PCU/hr)	Start queue (PCU)	End queue (PCU)	Delay (s)	Unsignalised level of service
1 - Junction Access	B-CD	22	6	386	0.057	22	0.1	0.1	9.902	A
	B-AD	22	6	391	0.056	22	0.1	0.1	9.754	A
	A-B	136	34			136				
	A-C	843	211			843				
	A-D	0	0	574	0.000	0	0.0	0.0	0.000	A
	D-ABC	0	0	477	0.000	0	0.0	0.0	0.000	A
	C-ABD	0	0	384	0.000	0	0.0	0.0	0.000	A
	C-D	0	0			0				
2 - Right Turn Bay Give Way	C-A	0	0			0				
	B-AC	0	0	633	0.000	0	0.0	0.0	0.000	A
	C-AB	0	0	572	0.000	0	0.0	0.0	0.000	A
	A-B	0	0			0				
	A-C	44	11			44				
3 - Eastbound Give Way	B-AC	44	11	540	0.082	44	0.1	0.1	7.262	A
	C-A	1085	271			1085				
	C-B	0	0	574	0.000	0	0.0	0.0	0.000	A
	A-B	0	0			0				
	A-C	0	0			0				

01:15 - 01:30

Junction	Stream	Total Demand (PCU/hr)	Junction Arrivals (PCU)	Capacity (PCU/hr)	RFC	Throughput (PCU/hr)	Start queue (PCU)	End queue (PCU)	Delay (s)	Unsignalised level of service
1 - Junction Access	B-CD	18	5	423	0.044	19	0.1	0.0	8.912	A
	B-AD	18	5	427	0.043	19	0.1	0.0	8.810	A
	A-B	114	28			114				
	A-C	706	177			706				
	A-D	0	0	574	0.000	0	0.0	0.0	0.000	A
	D-ABC	0	0	498	0.000	0	0.0	0.0	0.000	A
	C-ABD	0	0	415	0.000	0	0.0	0.0	0.000	A
	C-D	0	0			0				
2 - Right Turn Bay Give Way	C-A	0	0			0				
	B-AC	0	0	634	0.000	0	0.0	0.0	0.000	A
	C-AB	0	0	572	0.000	0	0.0	0.0	0.000	A
	A-B	0	0			0				
	A-C	37	9			37				
3 - Eastbound Give Way	B-AC	37	9	572	0.064	37	0.1	0.1	6.725	A
	C-A	909	227			909				
	C-B	0	0	574	0.000	0	0.0	0.0	0.000	A
	A-B	0	0			0				
	A-C	0	0			0				



**Appendix R**  
**Maidstone Road Junction Existing Layout Modelling Results**  
**(Linsig)**

Full Input Data And Results  
**Full Input Data And Results**

**User and Project Details**

Project:	
Title:	
Location:	
Additional detail:	
File name:	Maidstone Road (Existing Layout).lsg3x
Author:	D.Smith
Company:	Stantec UK
Address:	

**Network Layout Diagram**

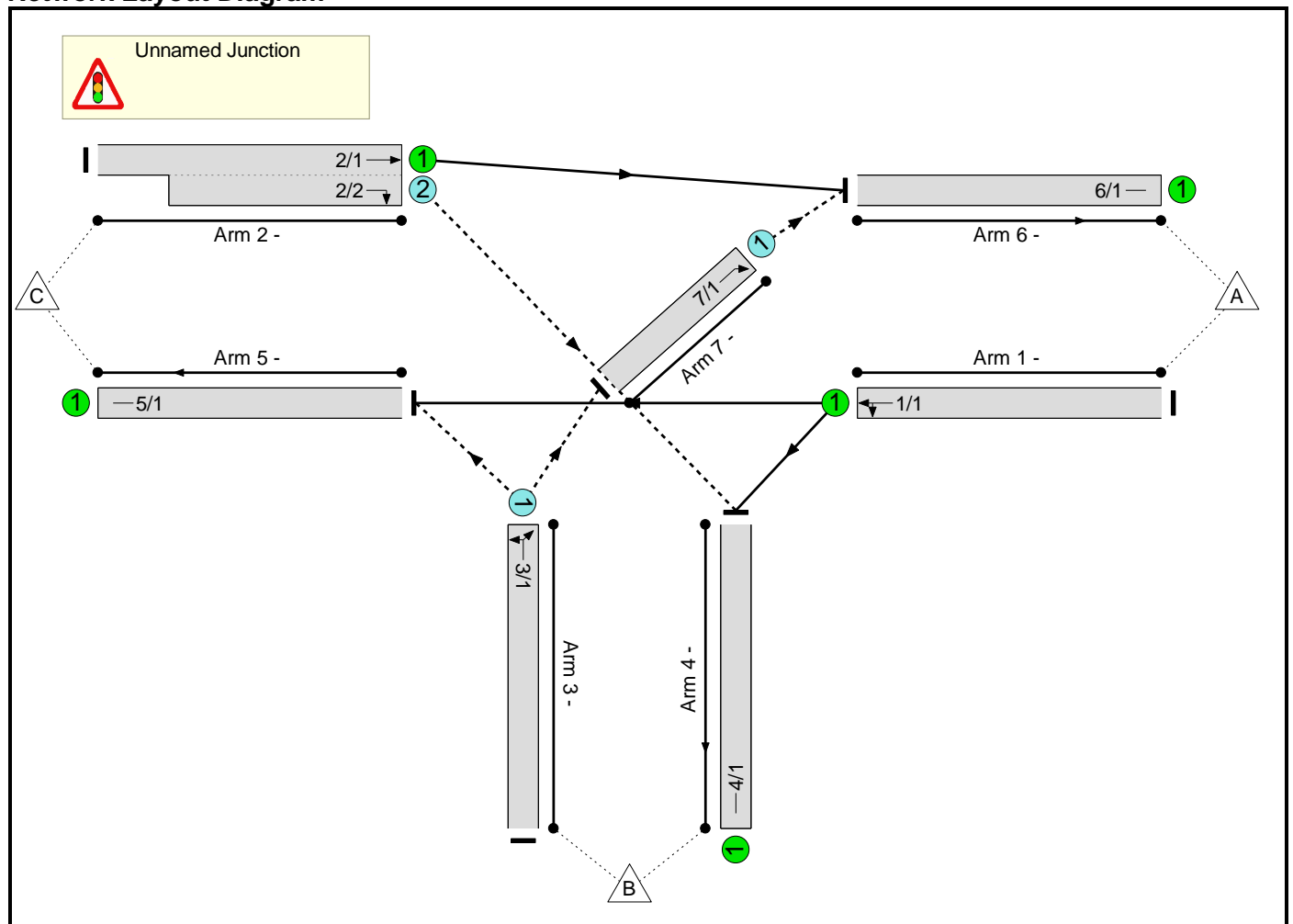

### Phase Diagram

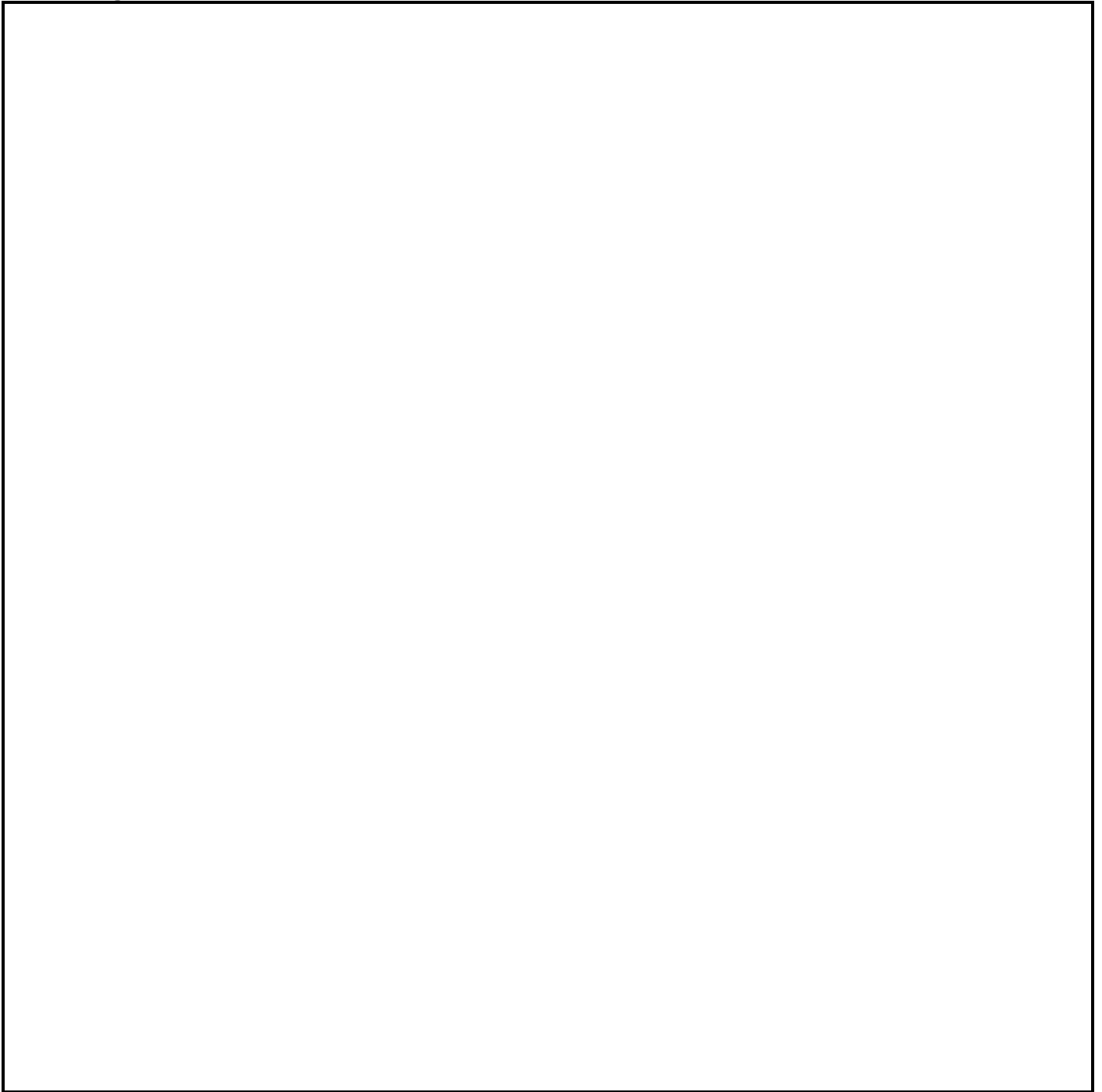

### Phase Input Data

Phase Name	Phase Type	Assoc. Phase	Street Min	Cont Min
------------	------------	--------------	------------	----------

### Phase Intergreens Matrix

	Starting Phase
Terminating Phase	This View cannot be shown as there are currently no Phases defined.

### Phases in Stage

Stage No.	Phases in Stage
-----------	-----------------

## Full Input Data And Results

### Stage Diagram

There are no Stages to display

### Phase Delays

Term. Stage	Start Stage	Phase	Type	Value	Cont value
There are no Phase Delays defined					

### Prohibited Stage Change

	To Stage
From Stage	This View cannot be shown as there are currently no Stages defined.

Full Input Data And Results

**Give-Way Lane Input Data**

Junction: Unnamed Junction											
Lane	Movement	Max Flow when Giving Way (PCU/Hr)	Min Flow when Giving Way (PCU/Hr)	Opposing Lane	Opp. Lane Coeff.	Opp. Mvmnts.	Right Turn Storage (PCU)	Non-Blocking Storage (PCU)	RTF	Right Turn Move up (s)	Max Turns in Intergreen (PCU)
2/2	4/1 (Right)	600	0	1/1	0.35	All	-	-	-	-	-
				3/1	0.22	To 7/1 (Right)					
				7/1	0.22	All					
3/1	5/1 (Left)	715	0	1/1	0.22	To 5/1 (Ahead)	-	-	-	-	-
	7/1 (Right)	600	0	1/1	0.22	To 5/1 (Ahead)					
7/1	6/1 (Ahead)	600	0	2/1	0.19	All	-	-	-	-	-

Full Input Data And Results

**Lane Input Data**

Junction: Unnamed Junction												
Lane	Lane Type	Phases	Start Disp.	End Disp.	Physical Length (PCU)	Sat Flow Type	Def User Saturation Flow (PCU/Hr)	Lane Width (m)	Gradient	Nearside Lane	Turns	Turning Radius (m)
1/1	U		2	3	60.0	Geom	-	4.50	0.00	Y	Arm 4 Left	Inf
											Arm 5 Ahead	Inf
2/1	U		2	3	60.0	Geom	-	4.50	0.00	Y	Arm 6 Ahead	Inf
2/2	O		2	3	11.5	Geom	-	4.28	0.00	Y	Arm 4 Right	Inf
3/1	O		2	3	60.0	Geom	-	5.00	0.00	Y	Arm 5 Left	Inf
											Arm 7 Right	Inf
4/1	U		2	3	60.0	Inf	-	-	-	-	-	-
5/1	U		2	3	60.0	Inf	-	-	-	-	-	-
6/1	U		2	3	60.0	Inf	-	-	-	-	-	-
7/1	O		2	3	2.0	Geom	-	5.00	0.00	Y	Arm 6 Ahead	Inf

**Traffic Flow Groups**

Flow Group	Start Time	End Time	Duration	Formula
1: 'Option 1 AM'	08:00	09:00	01:00	
2: 'Option 1 PM'	17:00	18:00	01:00	
3: 'Option 2 AM'	08:00	09:00	01:00	
4: 'Option 2 PM'	17:00	18:00	01:00	

**Scenario 1: 'Option 1 AM'** (FG1: 'Option 1 AM', Plan 1: 'Network Control Plan 1')

**Traffic Flows, Desired**

**Desired Flow :**

	Destination				
		A	B	C	Tot.
Origin	A	0	217	1135	1352
	B	83	0	0	83
	C	913	0	0	913
	Tot.	996	217	1135	2348

Full Input Data And Results

**Traffic Lane Flows**

Lane	Scenario 1: Option 1 AM
<b>Junction: Unnamed Junction</b>	
1/1	1352
2/1 (with short)	913(In) 913(Out)
2/2 (short)	0
3/1	83
4/1	217
5/1	1135
6/1	996
7/1	83

**Lane Saturation Flows**

<b>Junction: Unnamed Junction</b>								
Lane	Lane Width (m)	Gradient	Nearside Lane	Allowed Turns	Turning Radius (m)	Turning Prop.	Sat Flow (PCU/Hr)	Flared Sat Flow (PCU/Hr)
1/1	4.50	0.00	Y	Arm 4 Left	Inf	16.1 %	2065	2065
				Arm 5 Ahead	Inf	83.9 %		
2/1	4.50	0.00	Y	Arm 6 Ahead	Inf	100.0 %	2065	2065
2/2	4.28	0.00	Y	Arm 4 Right	Inf	0.0 %	2043	2043
3/1	5.00	0.00	Y	Arm 5 Left	Inf	0.0 %	2115	2115
				Arm 7 Right	Inf	100.0 %		
4/1	Infinite Saturation Flow						Inf	Inf
5/1	Infinite Saturation Flow						Inf	Inf
6/1	Infinite Saturation Flow						Inf	Inf
7/1	5.00	0.00	Y	Arm 6 Ahead	Inf	100.0 %	2115	2115

**Scenario 2: 'Option 1 PM'** (FG2: 'Option 1 PM', Plan 1: 'Network Control Plan 1')

**Traffic Flows, Desired**

**Desired Flow :**

	Destination				
		A	B	C	Tot.
Origin	A	0	151	936	1087
	B	78	0	0	78
	C	1087	0	0	1087
	Tot.	1165	151	936	2252

Full Input Data And Results

**Traffic Lane Flows**

Lane	Scenario 2: Option 1 PM
<b>Junction: Unnamed Junction</b>	
1/1	1087
2/1 (with short)	1087(In) 1087(Out)
2/2 (short)	0
3/1	78
4/1	151
5/1	936
6/1	1165
7/1	78

**Lane Saturation Flows**

<b>Junction: Unnamed Junction</b>								
Lane	Lane Width (m)	Gradient	Nearside Lane	Allowed Turns	Turning Radius (m)	Turning Prop.	Sat Flow (PCU/Hr)	Flared Sat Flow (PCU/Hr)
1/1	4.50	0.00	Y	Arm 4 Left	Inf	13.9 %	2065	2065
				Arm 5 Ahead	Inf	86.1 %		
2/1	4.50	0.00	Y	Arm 6 Ahead	Inf	100.0 %	2065	2065
2/2	4.28	0.00	Y	Arm 4 Right	Inf	0.0 %	2043	2043
3/1	5.00	0.00	Y	Arm 5 Left	Inf	0.0 %	2115	2115
				Arm 7 Right	Inf	100.0 %		
4/1	Infinite Saturation Flow						Inf	Inf
5/1	Infinite Saturation Flow						Inf	Inf
6/1	Infinite Saturation Flow						Inf	Inf
7/1	5.00	0.00	Y	Arm 6 Ahead	Inf	100.0 %	2115	2115

**Scenario 3: 'Option 2 AM'** (FG3: 'Option 2 AM', Plan 1: 'Network Control Plan 1')

**Traffic Flows, Desired**

**Desired Flow :**

	Destination				
		A	B	C	Tot.
Origin	A	0	188	1197	1385
	B	70	0	0	70
	C	939	0	0	939
	Tot.	1009	188	1197	2394



Full Input Data And Results

**Traffic Lane Flows**

Lane	Scenario 3: Option 2 AM
<b>Junction: Unnamed Junction</b>	
1/1	1385
2/1 (with short)	939(In) 939(Out)
2/2 (short)	0
3/1	70
4/1	188
5/1	1197
6/1	1009
7/1	70

**Lane Saturation Flows**

<b>Junction: Unnamed Junction</b>								
Lane	Lane Width (m)	Gradient	Nearside Lane	Allowed Turns	Turning Radius (m)	Turning Prop.	Sat Flow (PCU/Hr)	Flared Sat Flow (PCU/Hr)
1/1	4.50	0.00	Y	Arm 4 Left	Inf	13.6 %	2065	2065
				Arm 5 Ahead	Inf	86.4 %		
2/1	4.50	0.00	Y	Arm 6 Ahead	Inf	100.0 %	2065	2065
2/2	4.28	0.00	Y	Arm 4 Right	Inf	0.0 %	2043	2043
3/1	5.00	0.00	Y	Arm 5 Left	Inf	0.0 %	2115	2115
				Arm 7 Right	Inf	100.0 %		
4/1	Infinite Saturation Flow						Inf	Inf
5/1	Infinite Saturation Flow						Inf	Inf
6/1	Infinite Saturation Flow						Inf	Inf
7/1	5.00	0.00	Y	Arm 6 Ahead	Inf	100.0 %	2115	2115

**Scenario 4: 'Option 2 PM'** (FG4: 'Option 2 PM', Plan 1: 'Network Control Plan 1')

**Traffic Flows, Desired**

**Desired Flow :**

		Destination			
		A	B	C	Tot.
Origin	A	0	151	938	1089
	B	49	0	0	49
	C	1207	0	0	1207
	Tot.	1256	151	938	2345

Full Input Data And Results

**Traffic Lane Flows**

Lane	Scenario 4: Option 2 PM
<b>Junction: Unnamed Junction</b>	
1/1	1089
2/1 (with short)	1207(In) 1207(Out)
2/2 (short)	0
3/1	49
4/1	151
5/1	938
6/1	1256
7/1	49

**Lane Saturation Flows**

<b>Junction: Unnamed Junction</b>								
Lane	Lane Width (m)	Gradient	Nearside Lane	Allowed Turns	Turning Radius (m)	Turning Prop.	Sat Flow (PCU/Hr)	Flared Sat Flow (PCU/Hr)
1/1	4.50	0.00	Y	Arm 4 Left	Inf	13.9 %	2065	2065
				Arm 5 Ahead	Inf	86.1 %		
2/1	4.50	0.00	Y	Arm 6 Ahead	Inf	100.0 %	2065	2065
2/2	4.28	0.00	Y	Arm 4 Right	Inf	0.0 %	2043	2043
3/1	5.00	0.00	Y	Arm 5 Left	Inf	0.0 %	2115	2115
				Arm 7 Right	Inf	100.0 %		
4/1	Infinite Saturation Flow						Inf	Inf
5/1	Infinite Saturation Flow						Inf	Inf
6/1	Infinite Saturation Flow						Inf	Inf
7/1	5.00	0.00	Y	Arm 6 Ahead	Inf	100.0 %	2115	2115

Scenario 1: 'Option 1 AM' (FG1: 'Option 1 AM', Plan 1: 'Network Control Plan 1')

**Stage Sequence Diagram**

**Stage Timings**

<b>Stage</b>
<b>Duration</b>
<b>Change Point</b>

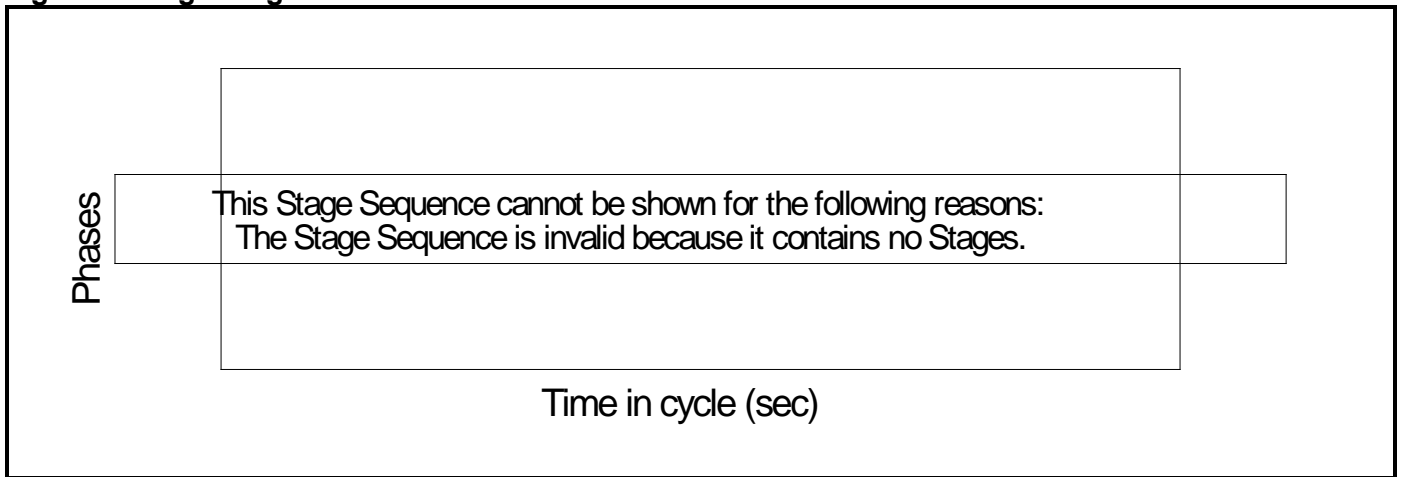

**Signal Timings Diagram**



Full Input Data And Results  
**Network Layout Diagram**

Full Input Data And Results

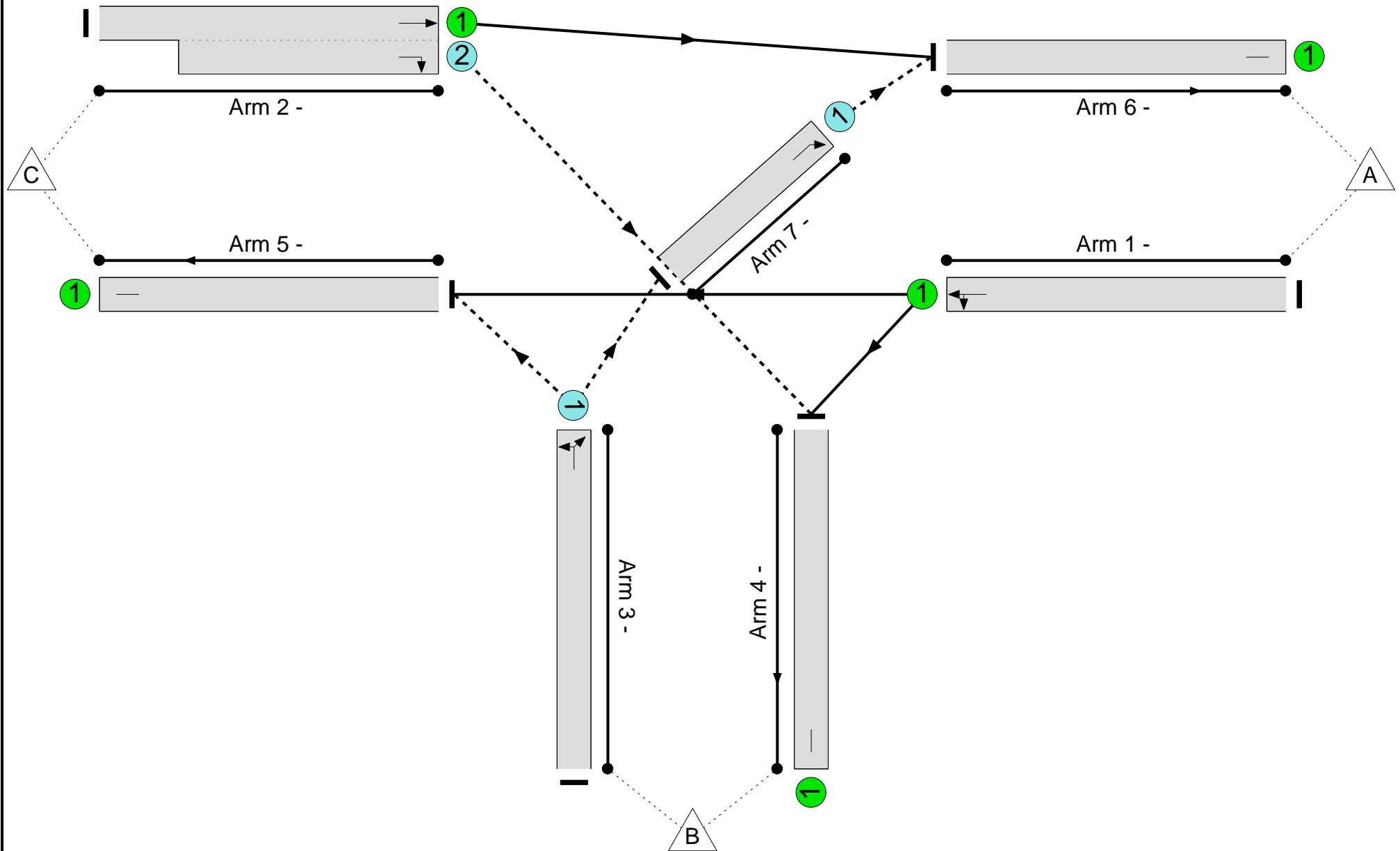
Unnamed Junction  
PRC: 37.5 %  
Total Traffic Delay: 1.6 pcuHr



Full Input Data And Results

Network Results

Item	Lane Description	Lane Type	Controller Stream	Position In Filtered Route	Full Phase	Arrow Phase	Num Greens	Total Green (s)	Arrow Green (s)	Demand Flow (pcu)	Sat Flow (pcu/Hr)	Capacity (pcu)	Deg Sat (%)
<b>Network</b>	-	-	N/A	-	-		-	-	-	-	-	-	65.5%
<b>Unnamed Junction</b>	-	-	N/A	-	-		-	-	-	-	-	-	65.5%
1/1	Left Ahead	U	N/A	N/A	-		-	-	-	1352	2065	2065	65.5%
2/1+2/2	Right Ahead	U+O	N/A	N/A	-		-	-	-	913	2065:2043	2065+0	44.2 : 0.0%
3/1	Left Right	O	N/A	N/A	-		-	-	-	83	2115	350	23.7%
4/1		U	N/A	N/A	-		-	-	-	217	Inf	Inf	0.0%
5/1		U	N/A	N/A	-		-	-	-	1135	Inf	Inf	0.0%
6/1		U	N/A	N/A	-		-	-	-	996	Inf	Inf	0.0%
7/1	Ahead	O	N/A	N/A	-		-	-	-	83	2115	426	19.5%
Item	Arriving (pcu)	Leaving (pcu)	Turners In Gaps (pcu)	Turners When Unopposed (pcu)	Turners In Intergreen (pcu)	Uniform Delay (pcuHr)	Rand + Oversat Delay (pcuHr)	Storage Area Uniform Delay (pcuHr)	Total Delay (pcuHr)	Av. Delay Per PCU (s/pcu)	Max. Back of Uniform Queue (pcu)	Rand + Oversat Queue (pcu)	Mean Max Queue (pcu)
<b>Network</b>	-	-	166	0	0	0.0	1.6	0.0	1.6	-	-	-	-
<b>Unnamed Junction</b>	-	-	166	0	0	0.0	1.6	0.0	1.6	-	-	-	-
1/1	1352	1352	-	-	-	0.0	0.9	-	0.9	2.5	0.0	0.9	0.9
2/1+2/2	913	913	0	0	0	0.0	0.4	-	0.4	1.6	0.0	0.4	0.4
3/1	83	83	83	0	0	0.0	0.2	-	0.2	6.7	0.0	0.2	0.2
4/1	217	217	-	-	-	0.0	0.0	-	0.0	0.0	0.0	0.0	0.0
5/1	1135	1135	-	-	-	0.0	0.0	-	0.0	0.0	0.0	0.0	0.0
6/1	996	996	-	-	-	0.0	0.0	-	0.0	0.0	0.0	0.0	0.0
7/1	83	83	83	0	0	0.0	0.1	-	0.1	5.2	0.0	0.1	0.1
C1			PRC for Signalled Lanes (%):		0.0	Total Delay for Signalled Lanes (pcuHr):			0.00	Cycle Time (s):		90	
			PRC Over All Lanes (%):		37.5	Total Delay Over All Lanes(pcuHr):			1.62				

**Stage Sequence Diagram**

**Stage Timings**

Stage
Duration
Change Point

**Signal Timings Diagram**

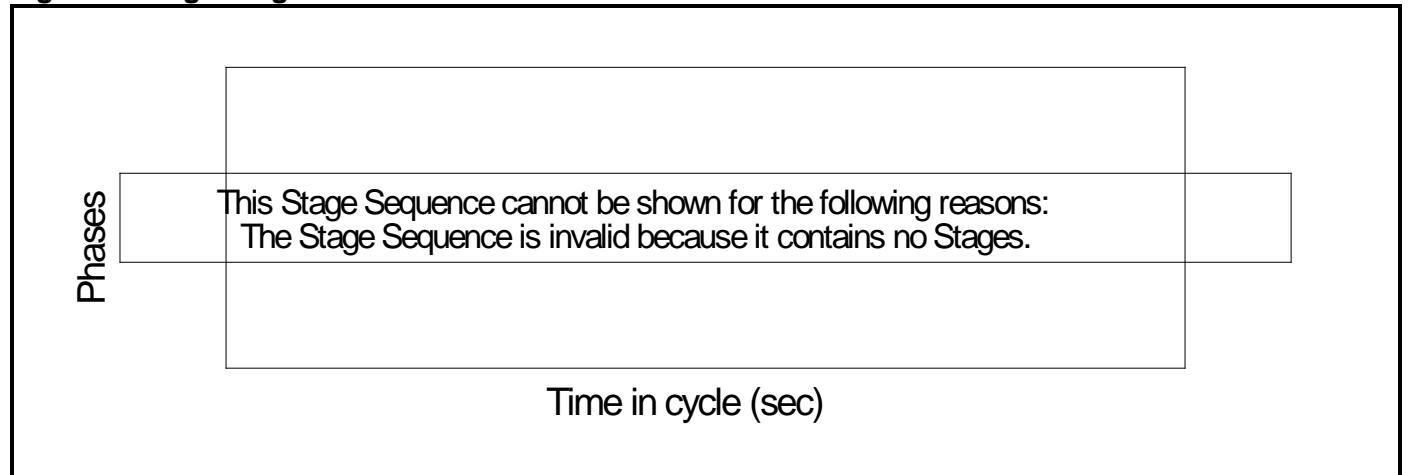



Full Input Data And Results  
**Network Layout Diagram**

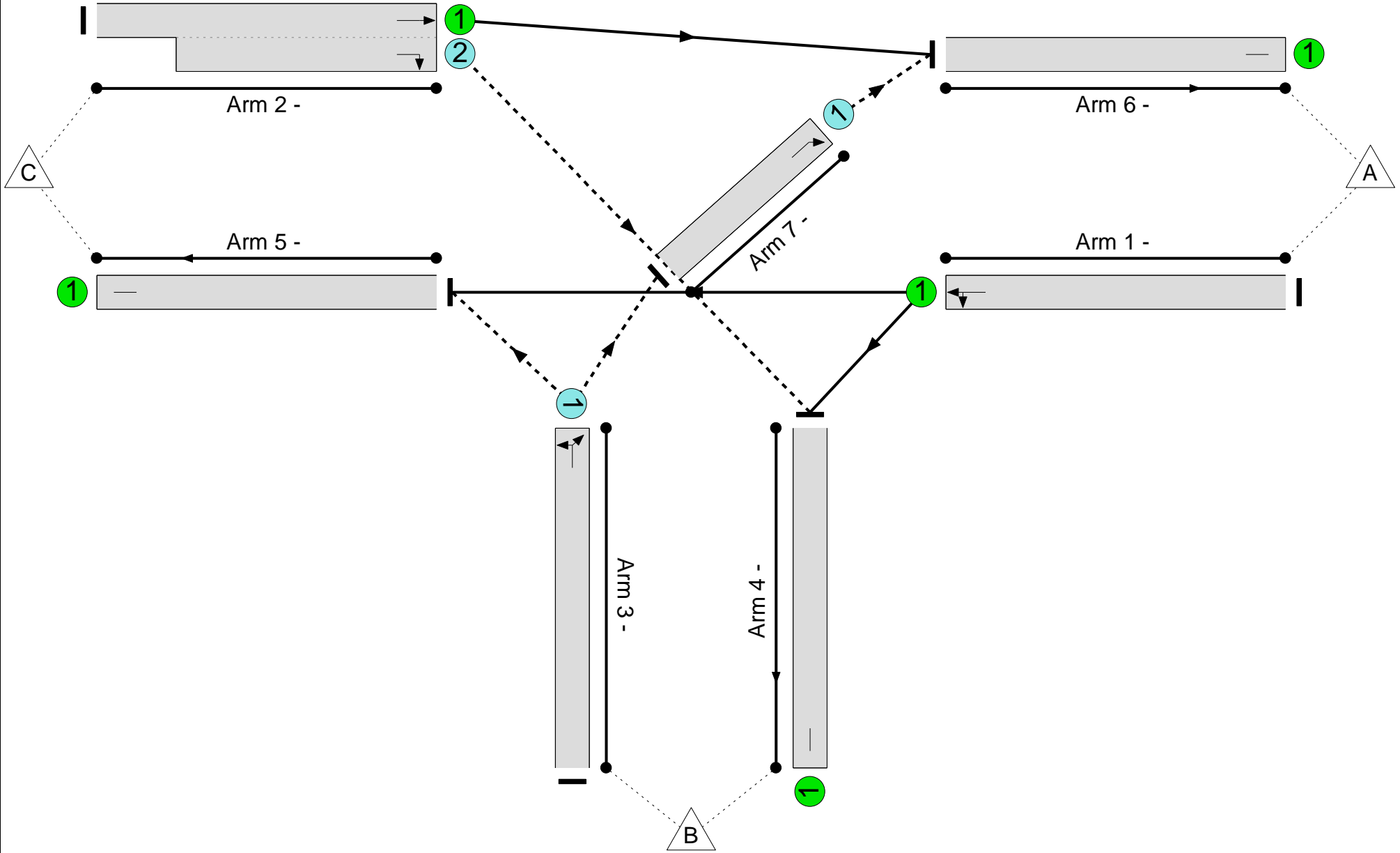

Full Input Data And Results

Unnamed Junction  
PRC: 71.0 %  
Total Traffic Delay: 1.4 pcuHr



Full Input Data And Results

Network Results

Item	Lane Description	Lane Type	Controller Stream	Position In Filtered Route	Full Phase	Arrow Phase	Num Greens	Total Green (s)	Arrow Green (s)	Demand Flow (pcu)	Sat Flow (pcu/Hr)	Capacity (pcu)	Deg Sat (%)
<b>Network</b>	-	-	N/A	-	-		-	-	-	-	-	-	52.6%
<b>Unnamed Junction</b>	-	-	N/A	-	-		-	-	-	-	-	-	52.6%
1/1	Left Ahead	U	N/A	N/A	-		-	-	-	1087	2065	2065	52.6%
2/1+2/2	Right Ahead	U+O	N/A	N/A	-		-	-	-	1087	2065:2043	2065+0	52.6 : 0.0%
3/1	Left Right	O	N/A	N/A	-		-	-	-	78	2115	394	19.8%
4/1		U	N/A	N/A	-		-	-	-	151	Inf	Inf	0.0%
5/1		U	N/A	N/A	-		-	-	-	936	Inf	Inf	0.0%
6/1		U	N/A	N/A	-		-	-	-	1165	Inf	Inf	0.0%
7/1	Ahead	O	N/A	N/A	-		-	-	-	78	2115	393	19.8%
Item	Arriving (pcu)	Leaving (pcu)	Turners In Gaps (pcu)	Turners When Unopposed (pcu)	Turners In Intergreen (pcu)	Uniform Delay (pcuHr)	Rand + Oversat Delay (pcuHr)	Storage Area Uniform Delay (pcuHr)	Total Delay (pcuHr)	Av. Delay Per PCU (s/pcu)	Max. Back of Uniform Queue (pcu)	Rand + Oversat Queue (pcu)	Mean Max Queue (pcu)
<b>Network</b>	-	-	156	0	0	0.0	1.4	0.0	1.4	-	-	-	-
<b>Unnamed Junction</b>	-	-	156	0	0	0.0	1.4	0.0	1.4	-	-	-	-
1/1	1087	1087	-	-	-	0.0	0.6	-	0.6	1.8	0.0	0.6	0.6
2/1+2/2	1087	1087	0	0	0	0.0	0.6	-	0.6	1.8	0.0	0.6	0.6
3/1	78	78	78	0	0	0.0	0.1	-	0.1	5.7	0.0	0.1	0.1
4/1	151	151	-	-	-	0.0	0.0	-	0.0	0.0	0.0	0.0	0.0
5/1	936	936	-	-	-	0.0	0.0	-	0.0	0.0	0.0	0.0	0.0
6/1	1165	1165	-	-	-	0.0	0.0	-	0.0	0.0	0.0	0.0	0.0
7/1	78	78	78	0	0	0.0	0.1	-	0.1	5.7	0.0	0.1	0.1
C1			PRC for Signalled Lanes (%):	0.0	Total Delay for Signalled Lanes (pcuHr):			0.00	Cycle Time (s):		90		
			PRC Over All Lanes (%):	71.0	Total Delay Over All Lanes(pcuHr):			1.36					

**Stage Sequence Diagram**

**Stage Timings**

Stage
Duration
Change Point

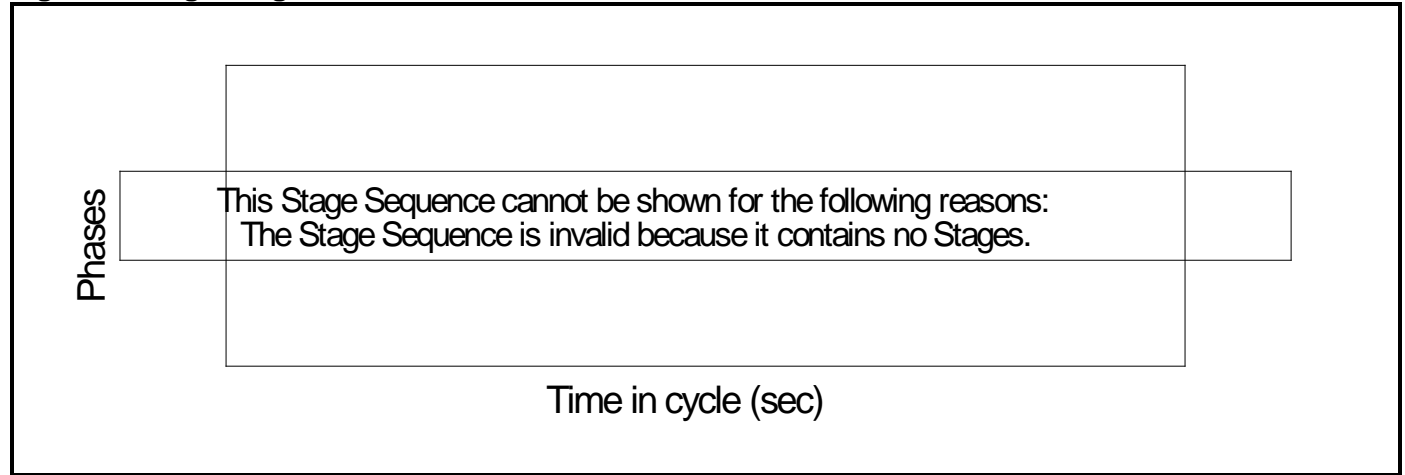

**Signal Timings Diagram**



Full Input Data And Results  
**Network Layout Diagram**

Full Input Data And Results

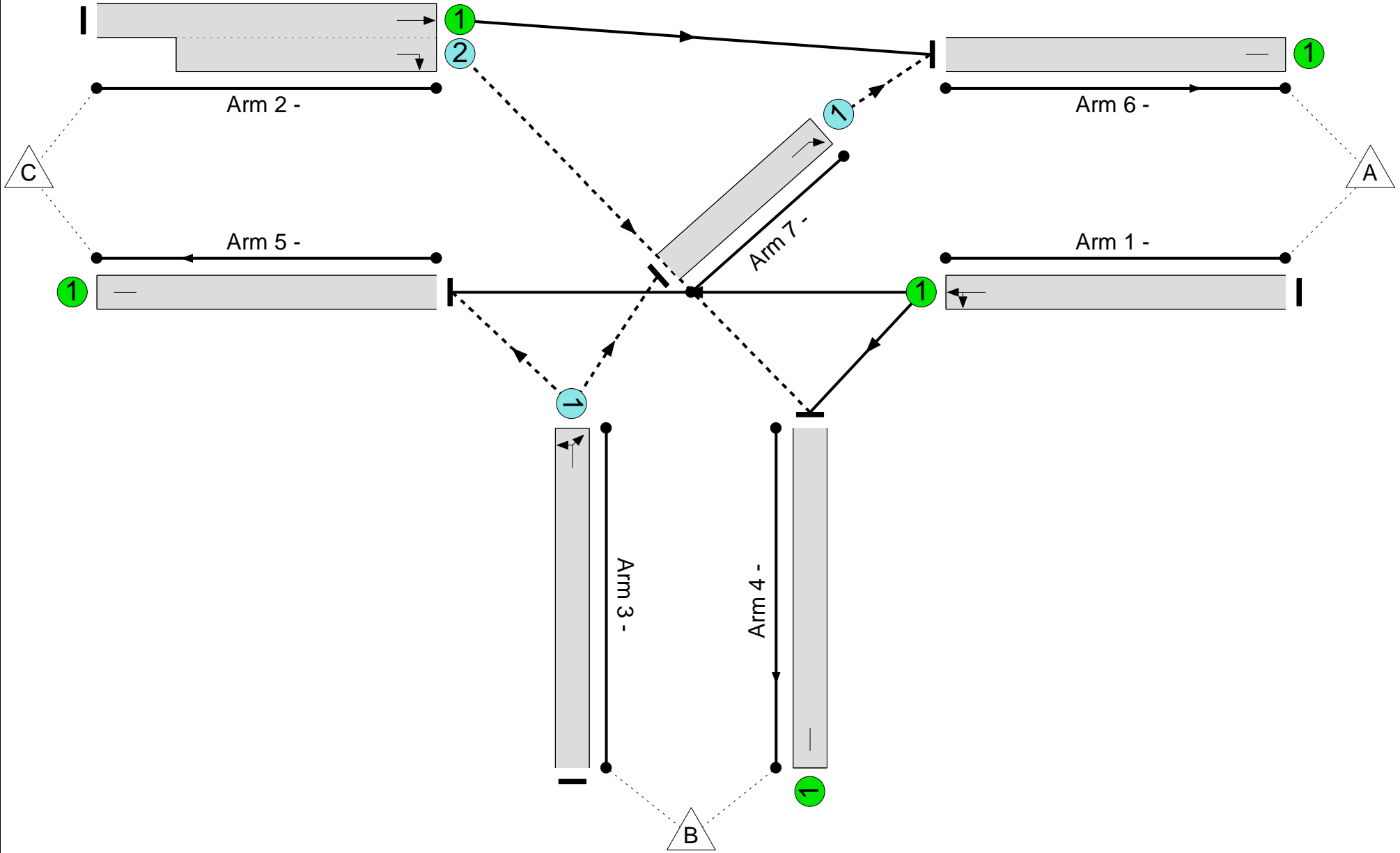
Unnamed Junction  
PRC: 34.2 %  
Total Traffic Delay: 1.7 pcuHr



Full Input Data And Results

Network Results

Item	Lane Description	Lane Type	Controller Stream	Position In Filtered Route	Full Phase	Arrow Phase	Num Greens	Total Green (s)	Arrow Green (s)	Demand Flow (pcu)	Sat Flow (pcu/Hr)	Capacity (pcu)	Deg Sat (%)
Network	-	-	N/A	-	-		-	-	-	-	-	-	67.1%
Unnamed Junction	-	-	N/A	-	-		-	-	-	-	-	-	67.1%
1/1	Left Ahead	U	N/A	N/A	-		-	-	-	1385	2065	2065	67.1%
2/1+2/2	Right Ahead	U+O	N/A	N/A	-		-	-	-	939	2065:2043	2065+0	45.5 : 0.0%
3/1	Left Right	O	N/A	N/A	-		-	-	-	70	2115	336	20.8%
4/1		U	N/A	N/A	-		-	-	-	188	Inf	Inf	0.0%
5/1		U	N/A	N/A	-		-	-	-	1197	Inf	Inf	0.0%
6/1		U	N/A	N/A	-		-	-	-	1009	Inf	Inf	0.0%
7/1	Ahead	O	N/A	N/A	-		-	-	-	70	2115	421	16.6%
Item	Arriving (pcu)	Leaving (pcu)	Turners In Gaps (pcu)	Turners When Unopposed (pcu)	Turners In Intergreen (pcu)	Uniform Delay (pcuHr)	Rand + Oversat Delay (pcuHr)	Storage Area Uniform Delay (pcuHr)	Total Delay (pcuHr)	Av. Delay Per PCU (s/pcu)	Max. Back of Uniform Queue (pcu)	Rand + Oversat Queue (pcu)	Mean Max Queue (pcu)
Network	-	-	140	0	0	0.0	1.7	0.0	1.7	-	-	-	-
Unnamed Junction	-	-	140	0	0	0.0	1.7	0.0	1.7	-	-	-	-
1/1	1385	1385	-	-	-	0.0	1.0	-	1.0	2.6	0.0	1.0	1.0
2/1+2/2	939	939	0	0	0	0.0	0.4	-	0.4	1.6	0.0	0.4	0.4
3/1	70	70	70	0	0	0.0	0.1	-	0.1	6.7	0.0	0.1	0.1
4/1	188	188	-	-	-	0.0	0.0	-	0.0	0.0	0.0	0.0	0.0
5/1	1197	1197	-	-	-	0.0	0.0	-	0.0	0.0	0.0	0.0	0.0
6/1	1009	1009	-	-	-	0.0	0.0	-	0.0	0.0	0.0	0.0	0.0
7/1	70	70	70	0	0	0.0	0.1	-	0.1	5.1	0.0	0.1	0.1
C1			PRC for Signalled Lanes (%):		0.0	Total Delay for Signalled Lanes (pcuHr):		0.00	Cycle Time (s):		90		
			PRC Over All Lanes (%):		34.2	Total Delay Over All Lanes(pcuHr):		1.66					

**Stage Sequence Diagram**

**Stage Timings**

Stage
Duration
Change Point

**Signal Timings Diagram**

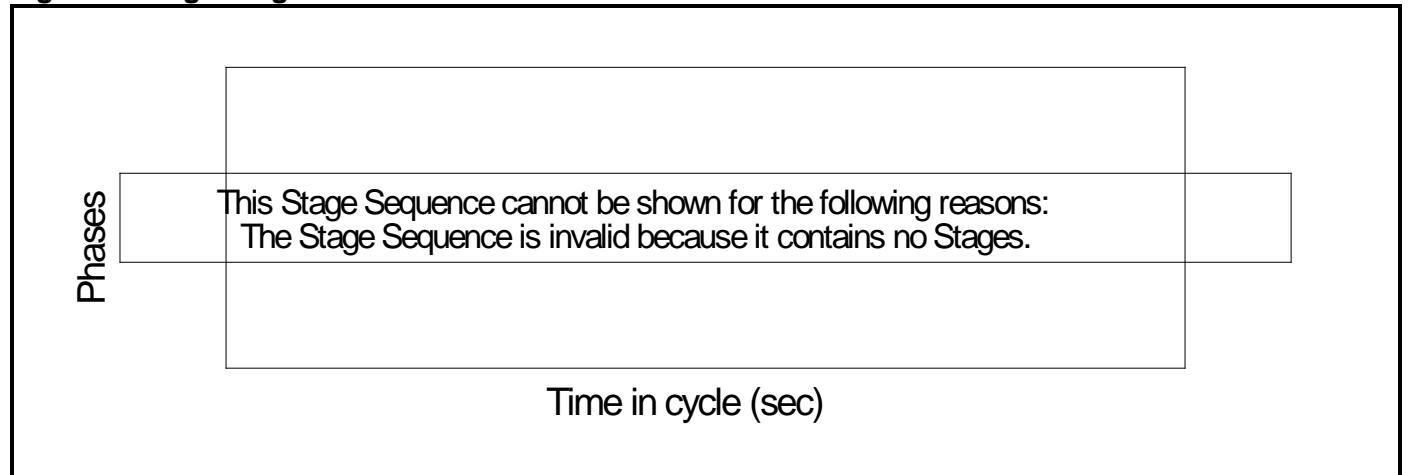



Full Input Data And Results  
**Network Layout Diagram**

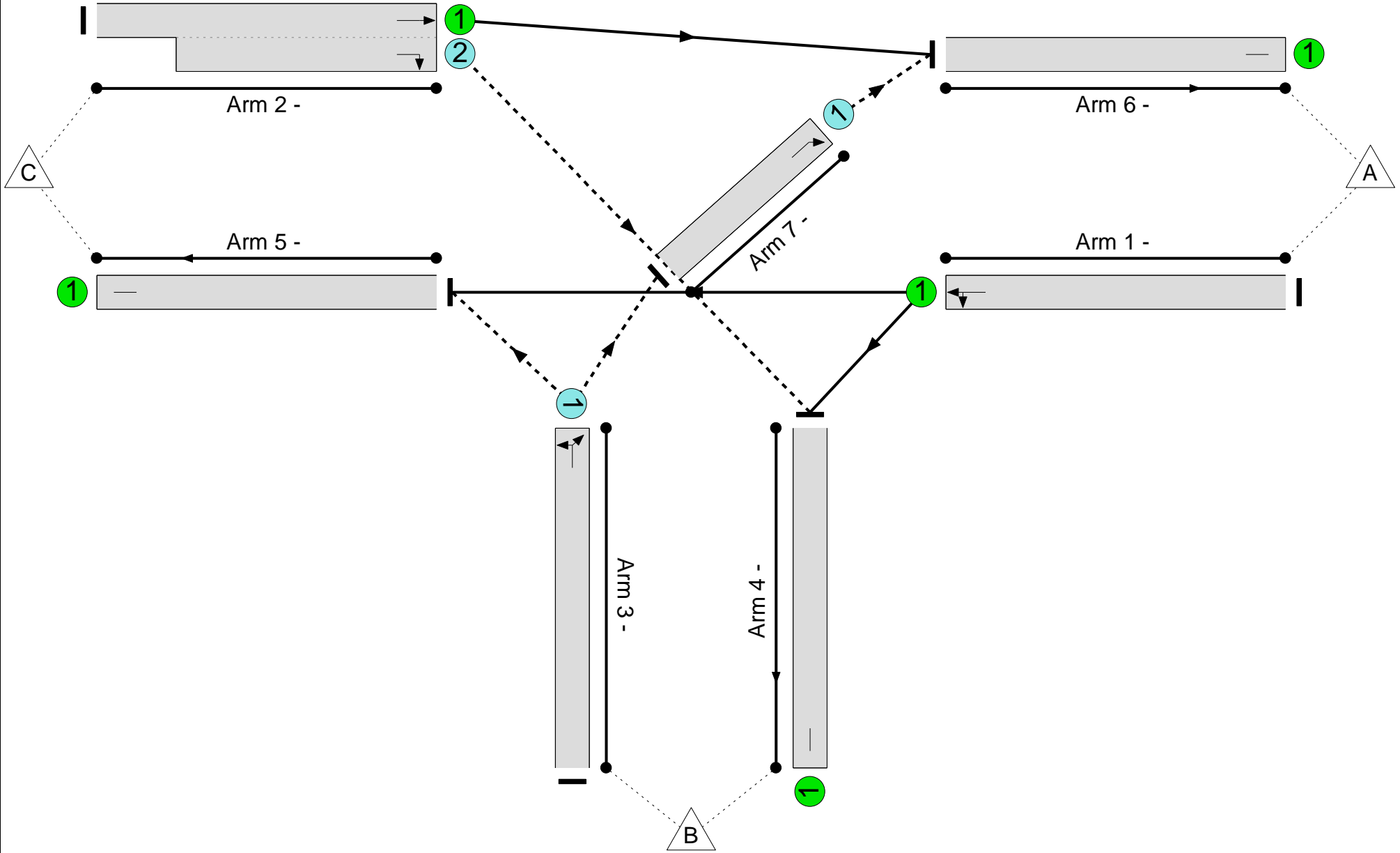

Full Input Data And Results

Unnamed Junction  
PRC: 54.0 %  
Total Traffic Delay: 1.4 pcuHr



Full Input Data And Results

Network Results

Item	Lane Description	Lane Type	Controller Stream	Position In Filtered Route	Full Phase	Arrow Phase	Num Greens	Total Green (s)	Arrow Green (s)	Demand Flow (pcu)	Sat Flow (pcu/Hr)	Capacity (pcu)	Deg Sat (%)
<b>Network</b>	-	-	N/A	-	-		-	-	-	-	-	-	58.5%
<b>Unnamed Junction</b>	-	-	N/A	-	-		-	-	-	-	-	-	58.5%
1/1	Left Ahead	U	N/A	N/A	-		-	-	-	1089	2065	2065	52.7%
2/1+2/2	Right Ahead	U+O	N/A	N/A	-		-	-	-	1207	2065:2043	2065+0	58.5 : 0.0%
3/1	Left Right	O	N/A	N/A	-		-	-	-	49	2115	393	12.5%
4/1		U	N/A	N/A	-		-	-	-	151	Inf	Inf	0.0%
5/1		U	N/A	N/A	-		-	-	-	938	Inf	Inf	0.0%
6/1		U	N/A	N/A	-		-	-	-	1256	Inf	Inf	0.0%
7/1	Ahead	O	N/A	N/A	-		-	-	-	49	2115	370	13.2%
Item	Arriving (pcu)	Leaving (pcu)	Turners In Gaps (pcu)	Turners When Unopposed (pcu)	Turners In Intergreen (pcu)	Uniform Delay (pcuHr)	Rand + Oversat Delay (pcuHr)	Storage Area Uniform Delay (pcuHr)	Total Delay (pcuHr)	Av. Delay Per PCU (s/pcu)	Max. Back of Uniform Queue (pcu)	Rand + Oversat Queue (pcu)	Mean Max Queue (pcu)
<b>Network</b>	-	-	98	0	0	0.0	1.4	0.0	1.4	-	-	-	-
<b>Unnamed Junction</b>	-	-	98	0	0	0.0	1.4	0.0	1.4	-	-	-	-
1/1	1089	1089	-	-	-	0.0	0.6	-	0.6	1.8	0.0	0.6	0.6
2/1+2/2	1207	1207	0	0	0	0.0	0.7	-	0.7	2.1	0.0	0.7	0.7
3/1	49	49	49	0	0	0.0	0.1	-	0.1	5.2	0.0	0.1	0.1
4/1	151	151	-	-	-	0.0	0.0	-	0.0	0.0	0.0	0.0	0.0
5/1	938	938	-	-	-	0.0	0.0	-	0.0	0.0	0.0	0.0	0.0
6/1	1256	1256	-	-	-	0.0	0.0	-	0.0	0.0	0.0	0.0	0.0
7/1	49	49	49	0	0	0.0	0.1	-	0.1	5.6	0.0	0.1	0.1
C1			PRC for Signalled Lanes (%):		0.0	Total Delay for Signalled Lanes (pcuHr):		0.00	Cycle Time (s):		90		
			PRC Over All Lanes (%):		54.0	Total Delay Over All Lanes(pcuHr):		1.41					